

**KIT VIDEOCITOFONICO A 2 FILI MONO E BIFAMILIARE CON  
RINVIO DI CHIAMATA  
ONE- AND TWO-FAMILY 2-WIRE KIT WITH CALL FORWARDING  
FUNCTION**

**KIT VIDEOPHONE 2 FILS MONO/BI-FAMILLE AVEC RENVOI  
D'APPEL**

**KIT VIDEOINTERFÓNICO DE 2 HILOS MONO Y BIFAMILIAR CON  
REENVÍO DE LLAMADA**

**2-DRAHT-VIDEOSPRECHANLAGEN-KIT FÜR EIN- UND  
ZWEIFAMILIENHÄUSER MIT RUFUMLEITUNG**

**KIT VIDEO-INTERCOM MET 2 DRADEN VOOR ÉÉN EN TWEE  
WONINGEN MET DOORVERBINDING**

**Sch. / Ref. 1723/95 - 1723/96<sup>(\*)</sup>**

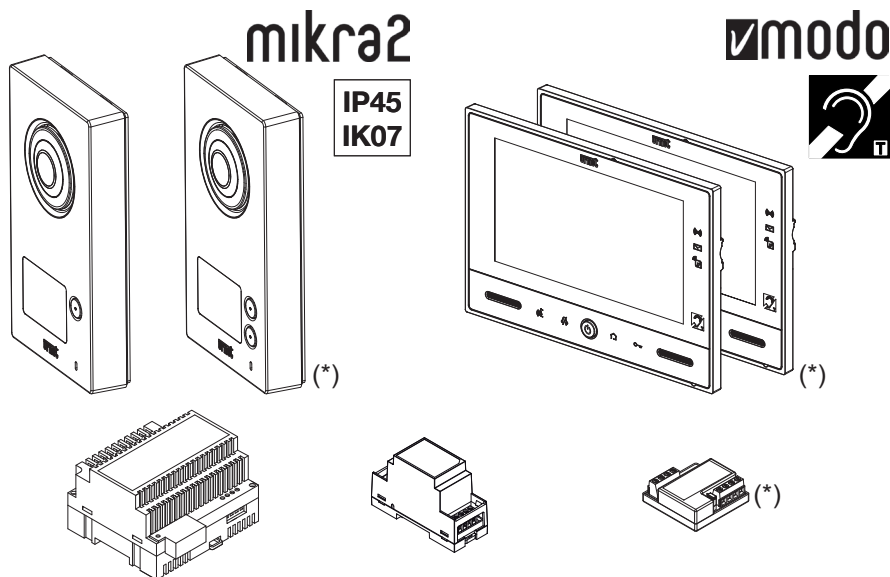

**LIBRETTO INSTALLAZIONE  
INSTALLATION HANDBOOK  
MANUEL D'INSTALLATION  
MANUAL DE INSTALACIÓN  
INSTALLATIONSANLEITUNG  
HANDLEIDING VOOR INSTALLATIE**

## INDICE

1	DESCRIZIONE GENERALE.....	3
2	COMPOSIZIONE DEL KIT .....	5
3	DISPOSITIVI ACCESSORI .....	7
4	PARTI DI RICAMBIO .....	9
5	SCHEMI A BLOCCHI DI COLLEGAMENTO .....	9
5.1	IMPIANTO MONOFAMILIARE.....	9
5.1.1	Distanze massime tra i dispositivi .....	9
5.2	IMPIANTO BIFAMILIARE.....	10
5.2.1	Distanze massime tra i dispositivi .....	10
6	AVVERTENZE PER L'INSTALLATORE .....	11
7	INSTALLAZIONE DEL VIDEOCITOFONO .....	12
7.1	DESCRIZIONE DEI COMPONENTI .....	12
7.2	MODALITA' DI INSTALLAZIONE .....	13
7.3	DESCRIZIONE DELLE MORSETTIERE.....	13
7.4	DESCRIZIONE DEL CONNETTORE PER LA TELECAMERA ESTERNA / RELE' 2 (OP20).....	14
7.5	FUNZIONI E CONFIGURAZIONI RELE' .....	14
7.6	CONFIGURAZIONE PONTICELLI (JP1 e JP2).....	14
7.7	CONFIGURAZIONE DIP-SWITCH.....	14
7.7.1	Associazione pulsante di chiamata a videocitofono .....	15
7.7.2	Codice del videocitofono .....	15
7.7.3	Tipologia di impianto .....	15
7.7.4	Attivazione della fonia con pressione del tasto (modalità "Push to talk").....	15
7.7.5	Impostazioni di fabbrica :.....	15
8	INSTALLAZIONE DELL'ALIMENTATORE DI SISTEMA E DELL'INDUTTANZA AUDIO VIDEO .....	16
8.1.1	Descrizione dei morsetti.....	16
9	INSTALLAZIONE DELLA PULSANTIERA.....	17
9.1	DESCRIZIONE DEI COMPONENTI .....	17
9.2	MODALITA' DI INSTALLAZIONE .....	18
9.3	DESCRIZIONE DEI MORSETTI .....	19
9.4	CONFIGURAZIONE DIP-SWITCH.....	19
9.4.1	Selezione della funzione STATO PORTA oppure LETTERBOX (segnalazione di presenza posta nella buca delle lettere) .....	19
9.4.2	N. identificativo della pulsantiera .....	19
9.4.3	Accensione dei led della telecamera in fase di chiamata .....	19
9.4.4	Abilitazione alla chiamata dell'appartamento 0 da parte di entrambi i pulsanti presenti in pulsantiera .....	19
9.4.5	Selezione del tipo di attivazione dell'elettroserratura pedonale e del passo carraio, se con scarica capacitiva oppure a relè con contatti puliti.....	19
9.4.6	Impostazione del tipo di pulsantiera .....	20
9.4.7	Regolazione del tempo di attivazione dell'elettroserratura con scarica capacitiva .....	20
9.4.8	Impostazioni di fabbrica.....	20
9.5	REGOLAZIONE LIVELLO FONICO ALTOPARLANTE .....	20
10	CARATTERISTICHE TECNICHE .....	20
11	LEGENDA SIMBOLI .....	21
12	DICHIARAZIONE DI CONFORMITÀ UE SEMPLIFICATA.....	21
13	SCHEMI DI COLLEGAMENTO .....	122
13.1	COLLEGAMENTO DEL KIT MONOFAMILIARE SCH.1723/95 CON 3 VIDEOCITOFONI IN PARALLELO.....	122
13.2	COLLEGAMENTO DEL KIT BIFAMILIARE SCH.1723/96 CON 3 VIDEOCITOFONI IN PARALLELO AD OGNI UTENZA.....	124
13.3	COLLEGAMENTO DELLA SUONERIA SUPPLEMENTARE AL VIDEOCITOFONO.....	126
13.4	LEGENDA SCHEMI .....	127
13.5	NOTE LEGATE AGLI SCHEMI.....	129
	<b>ENGLISH</b> .....	22
	<b>FRANÇAIS</b> .....	42
	<b>ESPAÑOL</b> .....	62
	<b>DEUTSCH</b> .....	82
	<b>VLAAMS</b> .....	102

# 1 DESCRIZIONE GENERALE

---

I kit videocitofonici Mod. NOTE2 sono caratterizzati dalla semplicità di installazione grazie all'utilizzo di 2 soli fili non polarizzati per l'interconnessione tra i vari dispositivi.

La sua modularità permette di implementare svariate funzioni supplementari oltre a quelle base del sistema videocitofonico, offrendo soluzioni adeguate ad ogni esigenza.

Le caratteristiche del sistema videocitofonico sono le seguenti:

## Sistema

- Kit monofamiliare sch. 1723/95:
  - Consente l'uso di 2 videocitofoni senza alcuna alimentazione supplementare;
  - Può gestire fino a 4 videocitofoni (1 "Master" e 3 "Slave") chiamati in parallelo, con collegamento entra-esci;
- Kit bifamiliare sch. 1723/96:
  - Consente l'uso di 2 videocitofoni senza alcuna alimentazione supplementare, 1 per appartamento;
  - Può gestire fino a 8 videocitofoni (2 "Master" e 6 "Slave") chiamati in parallelo, con distributore video di colonna e collegamento in entra-esci al piano;
- Collegamento di tutti i dispositivi con 2 soli fili non polarizzati;
- Collegamento dell'alimentatore in qualunque punto dell'impianto tra pulsantiera e videocitofono;
- Possibilità di gestire fino a 2 postazioni di chiamata in commutazione automatica;
- Possibilità di estendere la lunghezza dei bus mediante dispositivo addizionale;
- Configurazione dei dispositivi mediante ponticelli e dip-switch;
- Connessioni all'impianto tramite morsettiere estraibili.

## Pulsantiera

- Pulsantiera antivandalo Mod. MIKRA2 con frontale in zama resistente agli agenti atmosferici dotata di uno o due pulsanti;
- Installazione ad appoggio parete (standard), possibilità di installazione ad incasso con kit dedicato;
- Telecamera della pulsantiera a colori con ampio angolo di ripresa (wide-angle) e illuminazione del soggetto mediante led;
- MIFARE proximity key reader;
- Cartellino portanome retroilluminato di colore bianco;
- Attivazione dell'elettroserratura pedonale con scarica capacitiva ad impulso e corrente di mantenimento, con tempo di attivazione programmabile;
- Predisposizione per il collegamento di un pulsante androne per l'attivazione della serratura elettrica pedonale in locale;
- Predisposizione per il collegamento del sensore dedicato alla funzione STATO PORTA oppure LETTERBOX;
- Attivazione dell'elettroserratura pedonale avvicinando alla pulsantiera le chiavi di prossimità fornite a corredo;
- Pilotaggio elettroserratura passo carraio con relè con contatti puliti;
- Conferma di inoltro chiamata con segnalazione acustica e spegnimento dei led di retroilluminazione del cartellino;
- Accensione dei led della telecamera in fase di chiamata con possibilità di esclusione;
- Possibilità di regolare il livello fonico dell'altoparlante della pulsantiera;
- Segnalazione visiva e acustica dello stato dell'impianto (DDA), funzione disponibile solo con pulsantiera monofamiliare;
- Microfono integrato resistente all'acqua.

## Posto interno

- Posti interni videocitofonici Mod. VMODO viva-voce con schermo a colori LCD da 7" e touch-screen capacitivo;
- Installazione ad appoggio parete (standard), possibilità di installazione ad incasso con kit dedicato;
- Interfaccia utente disponibile in più lingue (IT, EN, FR, ES, DE, CS, NL, NO, PL, PT, SK, VLS);
- Modalità di conversazione a mani libere oppure con pressione del tasto (modalità "Push to talk"):
  - Mani libere: con una pressione del tasto fonia si attiva la conversazione e con una seconda pressione viene disattivata;
  - Push to talk: quando il tasto fonia è mantenuto premuto si può parlare dal posto interno mentre quando il tasto è rilasciato si può ascoltare;

- Melodie di chiamata: 5 standard più 1 personalizzabile dall'utente;
- Possibilità di attribuire melodie diverse a seconda della provenienza della chiamata (da pulsantiera, intercomunicante, chiamata al piano, segnalazione di allarme);
- Dotato di:
  - Dispositivo di ripetizione della fonia per audiolesi (ILA);
  - N.2 uscite configurabili a relè con contatti puliti per attivazione comandi ausiliari;
  - Retroilluminazione dei pulsanti touch con led rosso o verde;
- Possibilità di collegare direttamente al videocitofono:
  - Una telecamera TVCC locale sch. 1092/250A;
  - Un pulsante di chiamata al piano (solo su Master);
  - Un sensore di temperatura Yokis THERMPROBE (Cod. 5454488);
  - Un contatto di allarme (solo su Master);
- Possibilità di collegare a ciascun videocitofono, per la ripetizione della chiamata, una suoneria supplementare o un ripetitore di chiamata senza fili (solo per il mercato francese);
- Possibilità di cambiare il rapporto di visualizzazione dell'immagine da 4:3 a 16:9;
- Possibilità di regolazione audio (volume altoparlante) e video (luminosità, contrasto e colore);
- Regolabilità del volume di chiamata con possibilità di escluderlo a tempo (funzione mute);
- Segnalazione acustica escludibile di conferma pressione tasto;
- Supporto per memoria esterna: microSD (prestazione possibile solo se il videocitofono è installato ad appoggio parete);
- Funzioni calendario e orologio con tempo di backup di 2 ore in assenza di alimentazione di rete;
- Possibilità di sostituire la mascherina tasti del videocitofono con altre di diverso colore;
- Predisposizione per l'accensione luci scale tramite relè;
- Applicazioni di Home Automation (Yokis);
- Rilevazione e regolazione della temperatura all'interno dell'abitazione (funzione termostato) con sonda di temperatura opzionale;
- Possibilità di segnalare la presenza di posta nella buca delle lettere (funzione LETTERBOX, disponibile solo su videocitofono "Master" con dispositivi opzionali);
- Segnalazione mediante led di: videocitofono acceso, chiamata o conversazione in corso, mute attivo, attivazione di modulo radio Yokis, porta ingresso rimasta aperta, apriporta automatico attivo, funzione di rinvio di chiamata attiva, funzione allarme attivo, allarme in corso, presenza posta nella buca delle lettere (funzione LETTERBOX), presenza di nuovi messaggi audio (POST-IT), presenza di nuovi videomessaggi registrati;
- Possibilità di consultare lo storico eventi delle funzioni controllo accessi e allarme.

### Funzioni base

- Chiamata videocitofonica da posto esterno;
- Attivazione elettroserratura pedonale e seconda serratura (passo carraio), solo a seguito di una chiamata o a seguito di un'autoinserzione;
- Funzione di autoinserzione audio/video sulla pulsantiera;
- Chiamata intercomunicante tra singoli videocitofoni all'interno dello stesso appartamento;
- Chiamata intercomunicante di gruppo a tutti i videocitofoni appartenenti allo stesso appartamento;
- Chiamata intercomunicante di gruppo tra videocitofoni di appartamenti diversi (funzione disponibile solo con kit sch. 1723/96).













### Funzioni addizionali













- Possibilità di collegare fino a 4 telecamere TVCC nell'impianto con l'ausilio di un dispositivo dedicato;
- Funzione di autoinserzione ciclica in modalità automatica, da parte di qualsiasi videocitofono, sulle postazioni di chiamata, sulla propria telecamera locale e sulle telecamere TVCC presenti nell'impianto;
- Solo sul videocitofono "Master" è possibile:
  - Attivare la funzione di rinvio di una chiamata audio-video oppure solo audio verso uno Smartphone o tablet con sistema operativo Android oppure IOS;
  - Attivare una segreteria videocitofonica in grado di registrare fino a 32 videomessaggi da 10s;
  - Inviare un messaggio audio preregistrato al chiamante (durata massima 20s);
  - Attivare una registrazione solo video sincrona con la chiamata (fino a 32 registrazioni da 20s);
- Possibilità di registrare brevi messaggi audio (POST-IT) su qualsiasi videocitofono dell'impianto (max 32 messaggi da 20s);



















- Possibilità di attivare l'elettroserratura pedonale in automatico a seguito di una chiamata;
- Possibilità di registrazione video e memorizzazione anche su scheda microSD;
- Possibilità di esclusione del microfono;
- Possibilità di visualizzare data e ora, con la funzione aggiuntiva di agenda;
- Rilevazione di un allarme:
  - Segnalazione con led ed emissione di tono acustico sul videocitofono;
  - Ripetizione della segnalazione acustica su una sirena;
  - Attivazione di una telecamera per la ripresa delle immagini con registrazione automatica di un videomessaggio;
- Attivazione di moduli radio Yokis da qualsiasi videocitofono;
- Schedulazione delle attivazioni dei moduli radio Yokis in una o più occorrenze settimanali;
- Deviazione della chiamata e/o di allarme su smartphone, con dispositivo dedicato.
- Possibilità di aggiornare il firmware del sistema attraverso la scheda microSD.















## 2 COMPOSIZIONE DEL KIT

	Descrizione	N°	ID	
Pulsantiera (A)	Pulsantiera Mod. MIKRA2 con 1 tasto di chiamata (presente solo nel kit sch. 1723/95)	1		A1
	Pulsantiera Mod. MIKRA2 con 2 tasti di chiamata (presente solo nel kit sch. 1723/96)	1		A2
	Viti per fissaggio a parete (ø 3,5 x 32 mm)	4		A3
	Tasselli per fissaggio a parete (ø 5 mm)	4		A4
	Inserto per cacciavite (ø 2 mm)	1		A5
	Cartellino portanome grigio (in quantità 1 nel kit sch. 1723/95, in quantità 2 nel kit sch. 1723/96)	1/2		A6
	Cartellino portanome trasparente (in quantità 1 nel kit sch. 1723/95, in quantità 2 nel kit sch. 1723/96)	1/2		A7
	Vite a brugola di scorta per chiusura della pulsantiera (M3 x 12mm)	1		A8
	Chiave Master MIFARE per programmazione	1		A9
	Chiavi transponder MIFARE (in quantità 5 nel kit sch. 1723/95, in quantità 10 nel kit sch. 1723/96)	5/10		A10
	Chip tag (in quantità 2 nel kit sch. 1723/95, in quantità 4 nel kit sch. 1723/96)	2/4		A11
	Schermo in ferrite per chip tag (in quantità 2 nel kit sch. 1723/95, in quantità 4 nel kit sch. 1723/96)	2/4		A12
	Libretto istruzioni per chip tag (in quantità 1 nel kit sch. 1723/95, in quantità 2 nel kit sch. 1723/96)	1/2		A13

Posto interno (B)	Videocitofono "Master" 7" vivavoce Mod. VMODO (in quantità 1 nel kit sch. 1723/95, in quantità 2 nel kit sch. 1723/96)	1/2		B1
	Staffa per fissaggio a parete (in quantità 1 nel kit sch. 1723/95, in quantità 2 nel kit sch. 1723/96)	1/2		B2
	Viti per fissaggio a parete (ø 2,9 x 32 mm) (in quantità 4 nel kit sch. 1723/95, in quantità 8 nel kit sch. 1723/96)	4/8		B3
	Tasselli per fissaggio a parete (ø 5 mm) (in quantità 4 nel kit sch. 1723/95, in quantità 8 nel kit sch. 1723/96)	4/8		B4
	Viti per fissaggio su scatola incasso Mod.503 (M3,5 x 19 mm) (in quantità 2 nel kit sch. 1723/95, in quantità 4 nel kit sch. 1723/96)	2/4		B5
	Leva per la rimozione del frontalino del videocitofono (in quantità 1 nel kit sch. 1723/95, in quantità 2 nel kit sch. 1723/96)	1		B6
	Cavetto 6 vie per il collegamento di dispositivi opzionali (in quantità 1 nel kit sch. 1723/95, in quantità 2 nel kit sch. 1723/96)	1/2		B7
	Morsettiere estraibili per il collegamento del videocitofono all'impianto (in quantità 2 nel kit sch. 1723/95, in quantità 4 nel kit sch. 1723/96)	2/4		B8
	Cavetto 2 vie per il collegamento di una sonda di temperatura opzionale (in quantità 1 nel kit sch. 1723/95, in quantità 2 nel kit sch. 1723/96)	1/2		B9
	Alimentatore (C)	Alimentatore di sistema	1	
Induttanza audio video		1		C2
(D)	Distributore video (solo nel kit sch. 1723/96)	1		D

### 3 DISPOSITIVI ACCESSORI

Descrizione		N° max (nell'ipotesi di massima configurazione dell'impianto)	ID
Serratura elettrica (12 V~ Max 15 VA)	-	2 (una ogni pulsantiera)	 OP1
Pulsante per azionamento serratura elettrica pedonale	-	2 (uno ogni pulsantiera)	 OP2
Contatti del relè per l'attivazione apriporta passo carraio (corrente max commutabile 1A @ 30V)	-	2 (uno ogni pulsantiera)	 OP3
Sensore porta aperta	sch. 1033/701	2 (uno ogni pulsantiera)	 OP4 (*)
Suoneria Radio (disponibile solo su mercato francese)	cod. 43410	12 (3 ogni videocitofono)	 OP5 (**)
Suoneria supplementare (max 4 con kit sch. 1723/95, max 8 con kit sch. 1723/96)	sch. 9854/43	4/8 (una ogni videocitofono)	 OP5A (**)
Videocitofoni "Slave" supplementari 7" vivavoce Mod. VMODO (max 3 con kit sch. 1723/95, max 6 con kit sch. 1723/96)	sch. 1723/97	3/6	 OP6
Sensore di allarme magnetico	sch. 1033/701	2 (uno ogni videocitofono Master)	 OP7
Sensori presenza (NC in assenza di segnalazione)	sch. 1033/012 sch. 1033/132	4 (due ogni videocitofono Master)	 OP7a (#)
Pulsante di chiamata al piano	-	2 (uno ogni videocitofono Master)	 OP8
Pulsantiera secondaria monofamiliare Mod. MIKRA2	sch. 1723/11	1	 OP9
Pulsantiera secondaria bifamiliare Mod. MIKRA2	sch. 1723/12	1	 OP10
Tastiera per controllo accessi	sch. 1723/46	2 (una ogni pulsantiera)	 OP11
Kit da incasso per pulsantiera	sch. 1723/50	2 (una ogni pulsantiera)	 OP12
Scatola relè per 2 pulsantiere	sch. 1723/51	1	 OP13
Supporto tavolo per videocitofono 7" viva voce (max 4 se con kit sch. 1723/95, max 8 se con kit sch. 1723/96)	sch. 1723/52	4/8	 OP14
Kit da incasso per videocitofono 7" viva voce (max 4 se con kit sch. 1723/95, max 8 se con kit sch. 1723/96)	sch. 1723/60	4/8	 OP16







Interfaccia TVCC	sch. 1723/69	1		OP17
Dispositivo video BALUN passivo ad 1 canale	sch. 1092/300A	4 (uno per ogni telecamera connessa all'interfaccia TVCC)		
Kit chiavi Mifare	sch. 1723/102	massimo 21 chiavi nell'impianto		OP18
Telecamera compatta AHD DAY & NIGHT con ottica fissa 3.6mm (max 4 se con kit sch. 1723/95, max 8 se con kit sch. 1723/96)	sch. 1092/250A	4/8 (una per videocitofono)		OP19 (#)
Dispositivo video BALUN passivo ad 1 canale	sch. 1092/300A	4/8 (uno ogni telecamera sch. 1092/250A)		
Uscita programmabile che può essere attivata: - in seguito a pressione pulsante Home Automation (funzione luce scala di default), - in seguito a evento di allarme, - dalla funzione termostato.	-	-		OP20 (**)
Relè temporizzabile 2000W	cod. 5454462	uno per kit		OP21 (*)
Relè con bobina a 230V~	cod. 5454081	uno per kit		
Trasmettitore 2 canali per pulsanti Mod. E2BPP	cod. 5454413	1 (solo per il kit sch. 1723/95)		
Trasmettitore 4 canali per pulsanti Mod. E4BPP	cod. 5454427	2 (solo per il kit sch. 1723/96)		
Sensore di allarme magnetico (in quantità 2 con kit sch. 1723/95, in quantità 4 con kit sch. 1723/96)	sch. 1033/701	2/4		
Sonda di temperatura Yokis THERMPROBE (max 4 se con kit sch. 1723/95, max 8 se con kit sch. 1723/96)	cod. 5454488	4/8 (una ogni videocitofono)		OP22
Alimentatore per telecamera tipo sch. 1092/250A	sch. 1092/800	4 (uno ogni telecamera nel caso di impiego dell'interfaccia TVCC sch. 1723/69)		OP23
Trasformatore locale per 1723/97 (in quantità 2 con kit sch. 1723/95, in quantità 6 con kit sch. 1723/96)	sch. 1723/22	2/6 (uno ogni videocitofono Slave)		C4
Distributore video (presente solo nel kit sch. 1723/96)	sch. 1723/55	1		D

(\*) Le due opzioni sono mutuamente esclusive.

(\*\*) Per maggiori dettagli vedere paragrafo 7.5 - FUNZIONI E CONFIGURAZIONI RELÉ

(#) Le due opzioni sono mutuamente esclusive.

## 4 PARTI DI RICAMBIO

Descrizione		ID	Descrizione	ID
Alimentatore di sistema	sch. 1723/20	 C1	Videocitofono "Master" 7" vivavoce Mod. VMODO	sch. 1723/98  B1
Induttanza audio video	sch. 1723/112	 C2	Pulsantiera Mod. MIKRA2 con 1 tasto di chiamata (solo nel kit sch. 1723/95)	sch. 1723/11  A1
Distributore video	sch. 1723/55	 D	Pulsantiera Mod. MIKRA2 con 2 tasti di chiamata (solo nel kit sch. 1723/96)	sch. 1723/12  A2

## 5 SCHEMI A BLOCCHI DI COLLEGAMENTO

### 5.1 IMPIANTO MONOFAMILIARE

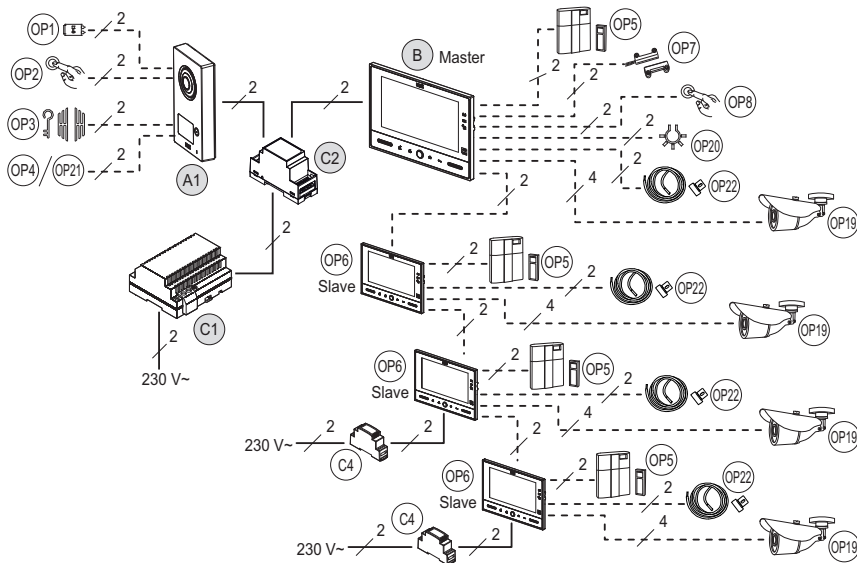

#### 5.1.1 Distanze massime tra i dispositivi

Tratta	Tipo di cavo					
	SYT1-3P-AWG20 (Ø 0,8 mm)	Doppino telefonico Ø 0,6 mm senza guaina	CAT5	1,5 mm <sup>2</sup> singolo	2Voice	PTT278
A1 - C2	150 m	150 m	100 m	75 m	200 m	100 m
C1 - C2	0,5 m	0,5 m	0,5 m	0,5 m	0,5 m	0,5 m
C2 - videocitofono più distante (OP6)	50 m	50 m	50 m	20 m	50 m	50 m
A - OP1	10 m	10 m	10 m	20 m	20 m	10 m
A - OP2	50 m	50 m	30 m	50 m	50 m	50 m
A - OP3	10 m	10 m	10 m	20 m	20 m	10 m
A - OP4	25 m	25 m	25 m	25 m	25 m	25 m
A - OP21	10 m	10 m	10 m	10 m	10 m	10 m
B - OP5	30 m	30 m	30 m	30 m	30 m	30 m
B - OP7	30 m	30 m	30 m	30 m	30 m	30 m
B - OP8	30 m	30 m	30 m	30 m	30 m	30 m
B - OP19	-	-	50 m	-	-	-
B - OP20	30 m	30 m	30 m	30 m	30 m	30 m
OP6 - C4	20 m	10 m	10 m	30 m	20 m	20 m
OP6 - OP5	30 m	30 m	30 m	30 m	30 m	30 m

 I cavi impiegati devono rispondere alla norma IEC 60332-1-2 se di sezione 0,5 mm<sup>2</sup> o superiore, oppure alla norma IEC 60332-2-2 se di sezione inferiore a 0,5 mm<sup>2</sup>.

## 5.2 IMPIANTO BIFAMILIARE

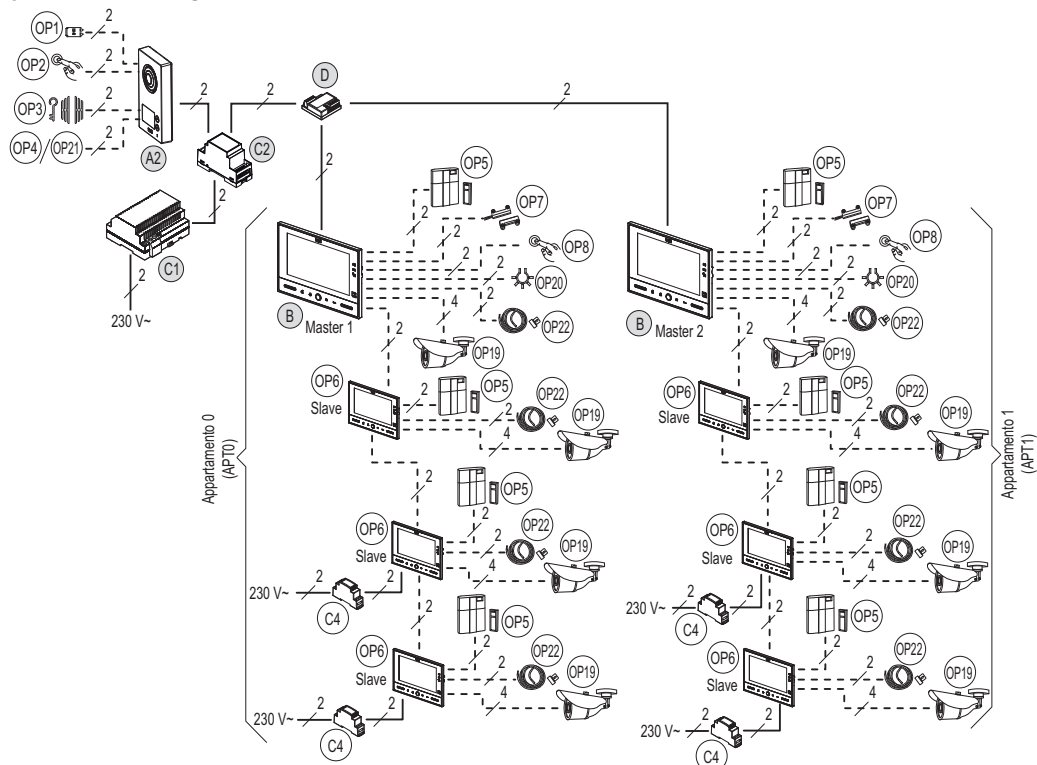

### 5.2.1 Distanze massime tra i dispositivi

Tratta	Tipo di cavo					
	SYT1-3P-AWG20 (Ø 0,8mm)	Doppino telefonico Ø 0,6 mm senza guaina	CAT5	1,5 mm <sup>2</sup> singolo	2Voice	PTT278
A2 - C2	150 m	150 m	100 m	75 m	200 m	100 m
C1 - C2	0,5 m	0,5 m	0,5 m	0,5 m	0,5 m	0,5 m
C2 - D	5 m	5 m	5 m	5 m	5 m	5 m
C2 - videocitofono più distante (OP6)	50 m	50 m	50 m	20 m	50 m	50 m
A - OP1	10 m	10 m	10 m	20 m	20 m	10 m
A - OP2	50 m	50 m	30 m	50 m	50 m	50 m
A - OP3	10 m	10 m	10 m	20 m	20 m	10 m
A - OP4	25 m	25 m	25 m	25 m	25 m	25 m
A - OP21	10 m	10 m	10 m	10 m	10 m	10 m
B - OP5	30 m	30 m	30 m	30 m	30 m	30 m
B - OP7	30 m	30 m	30 m	30 m	30 m	30 m
B - OP8	30 m	30 m	30 m	30 m	30 m	30 m
B - OP19	-	-	50 m	-	-	-
B - OP20	30 m	30 m	30 m	30 m	30 m	30 m
OP6 - C4	20 m	10 m	10 m	30 m	20 m	20 m
OP6 - OP5	30 m	30 m	30 m	30 m	30 m	30 m

⚡ I cavi impiegati devono rispondere alla norma IEC 60332-1-2 se di sezione 0,5 mm<sup>2</sup> o superiore, oppure alla norma IEC 60332-2-2 se di sezione inferiore a 0,5 mm<sup>2</sup>.

## 6 AVVERTENZE PER L'INSTALLATORE

Leggere attentamente le avvertenze contenute nel presente documento in quanto forniscono importanti indicazioni riguardanti la sicurezza di installazione, uso e manutenzione.

- I dispositivi facenti parte del kit dovranno essere destinati solo all'uso per il quale sono stati espressamente concepiti. Ogni altro uso è da considerarsi improprio. Il costruttore non può essere considerato responsabile per eventuali danni derivanti da usi impropri ed irragionevoli.
- Ogni parte è stata progettata in modo tale da essere conforme alle norme vigenti.
- L'esecuzione dell'impianto deve essere rispondente alle norme vigenti. Tutti gli apparecchi costituenti l'impianto, devono essere destinati esclusivamente all'uso per cui sono stati concepiti.
- Dopo aver tolto dall'imballaggio i vari componenti assicurarsi della loro integrità.
- Gli elementi dell'imballaggio (sacchetti di plastica, polistirolo espanso, ecc.) non devono essere lasciati alla portata dei bambini, in quanto potenziali fonti di pericolo.
- Prevedere a monte degli apparecchi un idoneo interruttore di sezionamento e protezione con distanza di apertura dei contatti di almeno 3mm.
- Prima di collegare i dispositivi di alimentazione accertarsi che i dati di targa siano rispondenti a quelli della rete di distribuzione.
- Non ostruire le aperture o fessure di ventilazione o smaltimento calore.
- Prima di effettuare qualsiasi operazione di pulizia o manutenzione, disinserire i dispositivi dalla rete di alimentazione elettrica spegnendo l'interruttore d'impianto.
- Non usare per la pulizia prodotti spray.
- In caso di guasto e/o cattivo funzionamento dei prodotti contenuti nel kit togliere l'alimentazione mediante l'interruttore generale e non manometterlo.
- Per l'eventuale riparazione rivolgersi solamente ad un centro di assistenza tecnico autorizzato dal costruttore.
- Provvedere ad una idonea ventilazione
- Non usare cavi di prolunga per il cavo rete di alimentazione.
- Nel caso di infiltrazione di liquidi o oggetti all'interno dell'apparecchio, affidare lo stesso a personale qualificato per controllo ed eventuale riparazione.
- Per le riparazioni usare esclusivamente le parti di ricambio fornite dalla casa.
- L'installatore deve assicurarsi che le informazioni per l'utente siano presenti sugli apparecchi derivati.
- Il mancato rispetto di quanto sopra può compromettere la sicurezza dell'installazione.
- Questo documento dovrà sempre essere allegato al prodotto.
- Il simbolo di fulmine con freccia all'interno di un triangolo equilatero segnala la presenza di tensioni pericolose.



- Non aprire i dispositivi se non espressamente indicato nel presente libretto istruzioni.
- Il simbolo di punto esclamativo all'interno di un triangolo equilatero segnala componenti critici per la sicurezza, usare pertanto solo componenti forniti dalla casa.



# 7 INSTALLAZIONE DEL VIDEOCITOFONO

## 7.1 DESCRIZIONE DEI COMPONENTI

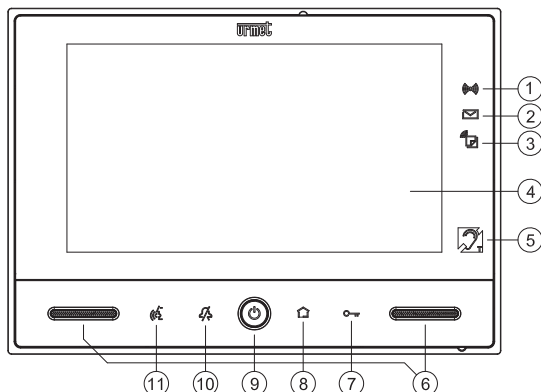

### Frontale:

1. Icona Allarme
2. Icona segnalazione presenza posta nella buca delle lettere (funzione LETTERBOX)
3. Icona indicazione segreteria telefonica attiva (verde fisso) / presenza messaggi audio POST-IT (rosso lampeggiante) / funzione di rinvio di chiamata attiva (giallo fisso) (solo su videocitofono master Sch. 1723/98).
4. Display 7"
5. Icona che indica che il videocitofono ha la ripetizione di fonia per gli audiolesi (ILA)
6. Altoparlanti
7. Pulsante (touch) apriporta
8. Icona conferma ricezione comando Yokis
9. Pulsante di accensione ON/OFF
10. Pulsante (touch) "MUTE"
11. Pulsante (touch) attivazione fonia

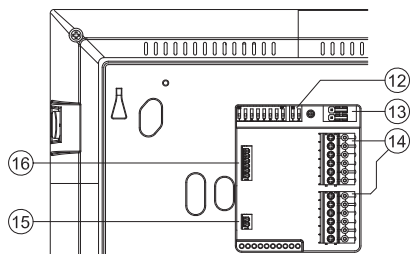

### Parte posteriore:

12. Dip-switch di configurazione
13. Ponticelli
14. Morsettiere estraibili a 6 vie
15. Connettore 2 vie per termostato esterno
16. Connettore 6 vie per collegamento telecamera esterna / relè 2 (OP20)



## 7.2 MODALITÀ DI INSTALLAZIONE

- Fissare la staffa alla parete utilizzando una scatola 503 e le viti in dotazione o una scatola  $\varnothing$  60 mm con viti adeguate.
- Programmare i dip-switch e collegare alle morsettiere i conduttori dell'impianto.
- Agganciare il videocitofono alla staffa in corrispondenza dei 4 ganci posti sui lati.
- Rimuovere la pellicola di protezione dal display.

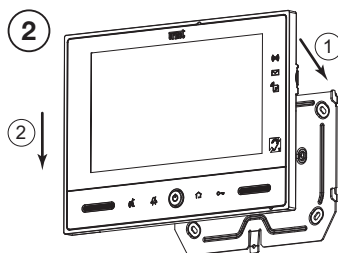
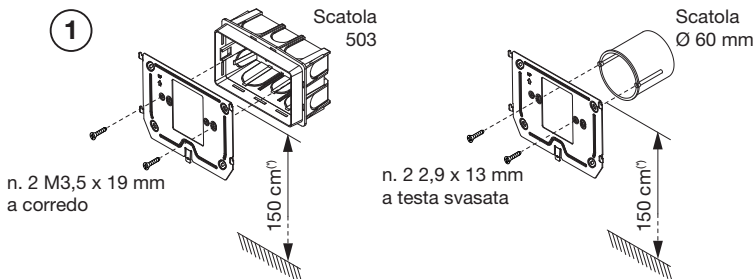

(\*) *Nel caso di persone con disabilità o specifiche necessità di tipo D1 (con età avanzata), D2 (con difficoltà motoria degli arti inferiori) e D3 (con difficoltà motoria degli arti superiori), il **centro del dispositivo** dovrà essere posizionato ad una altezza compresa tra 110 cm e 130 cm rispetto al piano di calpestio. Per ulteriori dettagli vedere la Norma tecnica CEI 64-21:2016-12 – Ambienti residenziali. Impianti adeguati all'utilizzo da parte di persone con disabilità o specifiche necessità.*

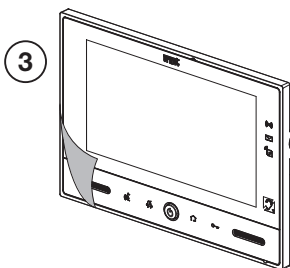

 *Rimuovere la pellicola di protezione dal display del videocitofono.*

## 7.3 DESCRIZIONE DELLE MORSETTIERE

Morsettiere	Nome morsetto	Descrizione
1	LI	Ingresso Bus (LINE IN)
	LO	
	LO	Uscita Bus (LINE OUT)
	LP	
	LP	24V~ alimentazione locale
2	FC	Chiamata al piano
	FC	
	0	Suoneria supplementare (uscita relè 1 – OP5 / OP5A)
	C	
	AL	Ingresso sensore allarme
	AL	

## 7.4 DESCRIZIONE DEL CONNETTORE PER LA TELECAMERA ESTERNA / RELE' 2 (OP20)

È possibile connettere al videocitofono "Master" la telecamera esterna sch. 1092/250A per mezzo del cavetto (B7) fornito a corredo.

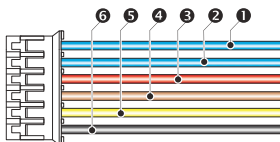

N. filo	Colore filo	Descrizione	Nome del pin sul connettore
1	Blu	Luci scale (uscita relè 2 – OP20)	RELAY SPARE
2	Blu	Luci scale (uscita relè 2 – OP20)	RELAY SPARE
3	Rosso	Positivo alimentazione telecamera	CCTV POWER+
4	Marrone	Negativo del segnale in uscita dal video balun	CCTV VIDEO-
5	Giallo	Positivo del segnale in uscita dal video balun	CCTV VIDEO+
6	Nero	Negativo alimentazione telecamera	CCTV POWER-

## 7.5 FUNZIONI E CONFIGURAZIONI RELE'



Il videocitofono è dotato di due relè programmabili come riportato nella tabella seguente:

Relè	Funzione possibile	Default	Riferimento
1	Suoneria supplementare	✓	OP5 / OP5A
	Pulsante Home Automation 1		
	Allarme sirena		
2	Pulsante Home Automation 2	✓	OP20
	Allarme sirena		
	Uscita termostato		



## 7.6 CONFIGURAZIONE PONTICELLI (JP1 e JP2)

Sul videocitofono sono presenti due ponticelli:

- JP1: permette di inserire la terminazione di linea. È necessario attivare la terminazione di linea sul videocitofono collegato alla fine di una linea che non riparta con una nuova tratta dai morsetti LINE OUT.

	JP1
Terminazione inserita (default)	
Terminazione non inserita	

- JP2: permette di alimentare il videocitofono dalla Linea Bus oppure attraverso un trasformatore locale sch. 1723/22.



	JP2
Alimentazione da linea Bus (default)	
Alimentazione da trasformatore locale	

## 7.7 CONFIGURAZIONE DIP-SWITCH

Il videocitofono ha 8 dip-switch posizionati sul retro del dispositivo.



 I dip-switch 5, 7 e 8 non sono usati.

### 7.7.1 Associazione pulsante di chiamata a videocitofono

	Posizione dip-switch 1		Posizione dip-switch 1
Videocitofono associato al pulsante di chiamata <b>0</b> (superiore)		Videocitofono associato al pulsante di chiamata <b>1</b> (inferiore)	

### 7.7.2 Codice del videocitofono

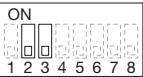
Qualora si desideri installare dei videocitofoni "Slave" è necessario impostare su ogni posto interno il relativo codice tramite i dip-switch 2 e 3.

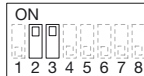

Tipologia di videocitofono	Posizione dip-switch 2 e 3	Tipologia di videocitofono	Posizione dip-switch 2 e 3
Videocitofono "Master"		Videocitofono "Slave" n° 1	
Videocitofono "Slave" n° 2		Videocitofono "Slave" n° 3	

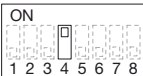
### 7.7.3 Tipologia di impianto

	Posizione dip-switch 4		Posizione dip-switch 4
Impianto monofamiliare		Impianto bifamiliare	



### 7.7.4 Attivazione della fonia con pressione del tasto (modalità "Push to talk")

Se la comunicazione tra la pulsantiera e il videocitofono risulta disturbata o assente, accertarsi di aver rimosso la pellicola trasparente che ricopre il display del videocitofono. Nel caso la pellicola sia stata rimossa e si riscontrino ancora disturbi sull'audio è possibile attivare i due canali di fonia (verso l'interno e verso l'esterno) singolarmente.

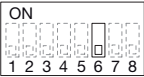
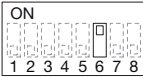
Dopo aver ricevuto una chiamata, premere brevemente  per attivare la fonia dalla pulsantiera, in seguito se viene mantenuto premuto il tasto  si attiva il canale audio verso l'esterno e si può parlare al chiamante. Per ascoltare occorre rilasciare il tasto .

	Posizione dip-switch 6		Posizione dip-switch 6
Funzione disattivata		Funzione attivata	

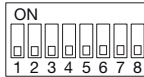
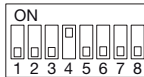
### 7.7.5 Impostazioni di fabbrica:

<b>Kit monofamiliare sch. 1723/95:</b>	Videocitofono	
<b>Kit bifamiliare sch. 1723/96:</b>	Videocitofono 1	
	Videocitofono 2	

## 8 INSTALLAZIONE DELL'ALIMENTATORE DI SISTEMA E DELL'INDUTTANZA AUDIO VIDEO

L'alimentatore deve essere installato all'interno di un quadro elettrico oppure di un armadietto.

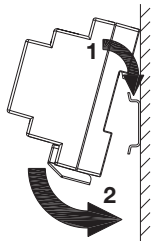

Installazione su barra DIN (6 moduli da 18 mm)

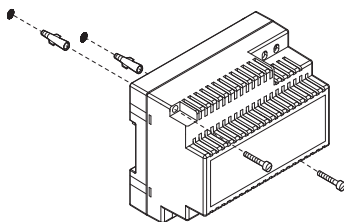

Installazione ad appoggio parete

Il modulo induttanza può essere fissato a parete tramite la staffa fornita a corredo oppure fissato su barra DIN (2 moduli da 18 mm).

Il modulo induttanza deve essere installato nello stesso quadro elettrico dell'alimentatore.

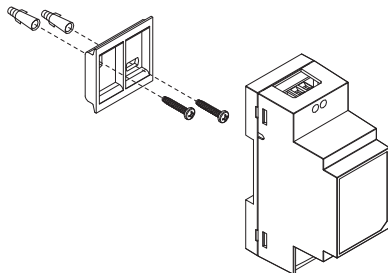

### 8.1.1 Descrizione dei morsetti

#### Alimentatore di sistema sch. 1723/20

- ⊗ 110-230V~ / N    Ingresso tensione di alimentazione di rete 110-230 V~
- ⊗ +                    } Uscita tensione di alimentazione
- ⊗ -

#### Induttanza audio video sch. 1723/112

- ⊗ +                    } Ingresso tensione di alimentazione
- ⊗ -
- ⊗ ] LINE1    Linea BUS 1
- ⊗ ] LINE2    Linea BUS 2

## 9 INSTALLAZIONE DELLA PULSANTIERA

### 9.1 DESCRIZIONE DEI COMPONENTI

Pulsantiera Mod. MIKRA2 con 1 tasto di chiamata  
(presente solo nel kit monofamiliare sch. 1723/95)

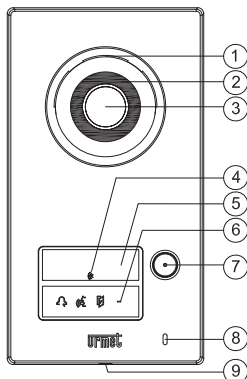

Pulsantiera Mod. MIKRA2 con 2 tasti di chiamata  
(presente solo nel kit bifamiliare sch. 1723/96)

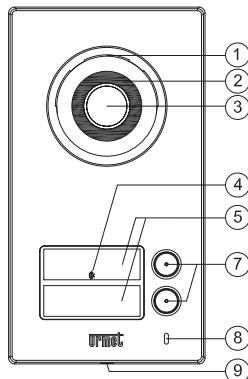

Frontale:

1. Altoparlante
2. Led di illuminazione telecamera
3. Telecamera
4. Lettore transponder
5. Cartellino/i portanome
6. Segnalazioni led dedicate alla funzione DDA
7. Pulsante/i di chiamata
8. Microfono
9. Vite chiusura frontale

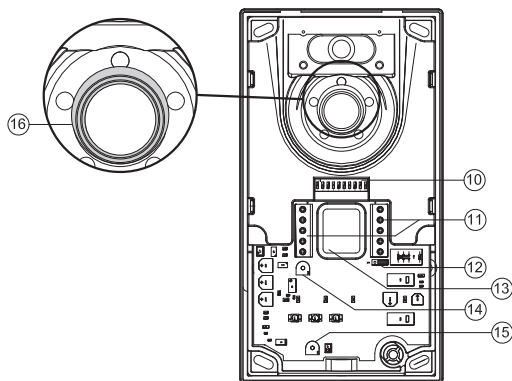

Parte interna:

10. Dip-switch di configurazione
11. Morsettiere
12. **Non variare la posizione di questo ponticello!**
13. Foro per passaggio cavi
14. Trimmer regolazione livello fonico altoparlante
15. **Non ruotare questo trimmer!**
16. Guarnizione antiriflesso

## 9.2 MODALITÀ DI INSTALLAZIONE

- Installare la pulsantiera all'altezza indicata verificando che il soggetto rientri nel campo inquadrato dalla telecamera
- Collegare i fili alle morsettiere
- Montare i cartellini portanome sul frontale
- Eseguire le programmazioni
- Se necessario regolare il livello fonico dell'altoparlante
- Chiudere la pulsantiera con la copertura metallica
- Rimuovere le pellicole di protezione

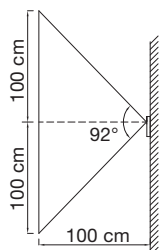

Campo di ripresa  
verticale

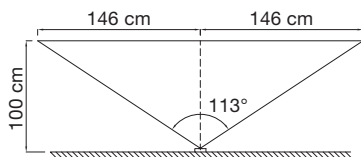

Campo di ripresa  
orizzontale

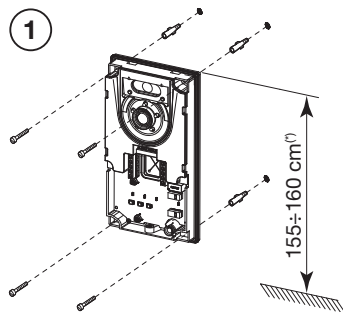

- (\*) *Nel caso di persone con disabilità o specifiche necessità di tipo D1 (con età avanzata) e D2 (con difficoltà motoria degli arti inferiori), il **centro del dispositivo** dovrà essere posizionato ad una altezza compresa tra 75 cm e 140 cm rispetto al piano di calpestio. Per ulteriori dettagli vedere la Norma tecnica CEI 64-21:2016-12 - Ambienti residenziali. Impianti adeguati all'utilizzo da parte di persone con disabilità o specifiche necessità.*

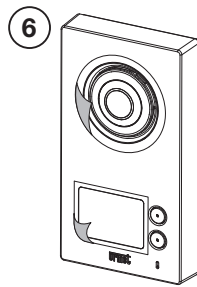
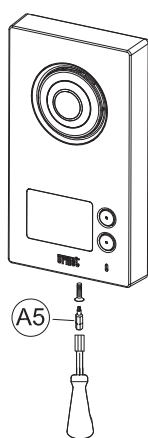
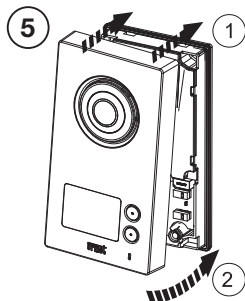
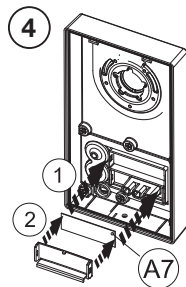
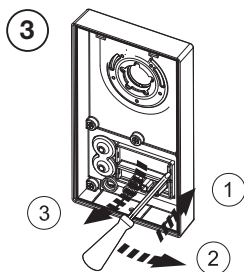
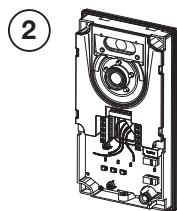

### 9.3 DESCRIZIONE DEI MORSETTI

#### Morsettiera sinistra

- ⊗ SE- Negativo azionamento elettroserratura con scarica capacitiva
- ⊗ SE+ Positivo azionamento elettroserratura con scarica capacitiva
- ⊗ ] PA Ingresso per pulsante serratura elettrica pedonale
- ⊗ SP Ingresso per sensore dedicato alla funzione STATO PORTA oppure LETTERBOX

#### Morsettiera destra



- ⊗ SP Ingresso per sensore dedicato alla funzione STATO PORTA oppure LETTERBOX
- ⊗ ] LINE Linea Bus
- ⊗ ] N.O. Azionamento contatto pulito apriporta (OP3)

### 9.4 CONFIGURAZIONE DIP-SWITCH



La pulsantiera ha 10 dip-switch posizionati all'interno del dispositivo.

🔧 ***1 dip-switch 6, 9 e 10 non devono essere variati.***



#### 9.4.1 Selezione della funzione STATO PORTA oppure LETTERBOX (segnalazione di presenza posta nella buca delle lettere)

	Posizione dip-switch 1		Posizione dip-switch 1
Funzione STATO PORTA attivata		Funzione LETTERBOX attivata	



#### 9.4.2 N. Identificativo della pulsantiera

	Posizione dip-switch 2		Posizione dip-switch 2
Pulsantiera 1		Pulsantiera 2	



#### 9.4.3 Accensione dei led della telecamera in fase di chiamata

	Posizione dip-switch 3		Posizione dip-switch 3
Funzione abilitata		Funzione disabilitata	



#### 9.4.4 Abilitazione alla chiamata dell'appartamento 0 da parte di entrambi i pulsanti presenti in pulsantiera (funzione disponibile solo con kit bifamiliare sch. 1723/96)

	Posizione dip-switch 4		Posizione dip-switch 4
Funzione disabilitata		Funzione abilitata	

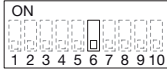

#### 9.4.5 Selezione del tipo di attivazione dell'elettroserratura pedonale e del passo carraio, se con scarica capacitiva oppure a relè con contatti puliti

	Posizione dip-switch 5		Posizione dip-switch 5
Attivazione dell'elettroserratura pedonale mediante scarica capacitiva ad impulso e corrente di mantenimento (morsetti SE+ e SE-); attivazione del passo carraio mediante relè con contatti puliti (morsetti N.O.).		Attivazione dell'elettroserratura pedonale mediante relè con contatti puliti (morsetti N.O.); attivazione del passo carraio mediante scarica capacitiva ad impulso e corrente di mantenimento (morsetti SE+ e SE-).	



#### 9.4.6 Impostazione del tipo di pulsantiera

	Posizione dip-switch 6		Posizione dip-switch 6
Pulsantiera monofamiliare		Pulsantiera bifamiliare	

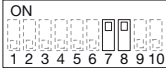
#### 9.4.7 Regolazione del tempo di attivazione dell'elettroserratura con scarica capacitiva

	Posizione dip-switch 7-8		Posizione dip-switch 7-8
0 secondi (impulso di 300ms)		3 secondi	
6 secondi		9 secondi	

#### 9.4.8 Impostazioni di fabbrica

<b>Kit monofamiliare sch. 1723/95:</b>	Pulsantiera 1	
<b>Kit bifamiliare sch. 1723/96:</b>	Pulsantiera 2	

### 9.5 REGOLAZIONE LIVELLO FONICO ALTOPARLANTE

I livelli fonici sono tarati di fabbrica in modo da non dover essere variati nella maggioranza delle installazioni. Qualora fosse necessario modificarli, agire con un cacciavite sull'apposita regolazione del volume dell'altoparlante (vedi punto 14 del paragrafo 9.1 - DESCRIZIONE DEI COMPONENTI).

## 10 CARATTERISTICHE TECNICHE

#### Alimentatore di sistema

Alimentatore in CAT III 4000 V

Alimentazione: ..... 110-230 V~ 50-60 Hz  
 Potenza: ..... 75 W max  
 Uscita secondario: ..... 50 V--- 1 A  
 Potenza assorbita dopo 1 ora di lavoro: ..... Max 5 Wh (18 kJ)  
 Dimensioni (LxAxP): ..... 108 (6 moduli DIN) x 90 x 61 mm

#### Induttanza audio video

Dimensioni (LxAxP): ..... 36 (2 moduli DIN) x 95 x 57 mm

#### Videocitofono

Tensione di alimentazione: ..... da BUS 37÷48 V---  
 Da trasformatore locale 24V~ (+-10%)

Assorbimento: massimo ..... 280 mA @ 48 V---  
 a riposo (configurazione base) ..... 25 mA @ 48 V---

Potenza assorbita in funzione: ..... max 16 W

Display a cristalli liquidi: ..... 7" IPS retroilluminato

Risoluzione: ..... 1024H x 600V pixel

Angolo di visuale ..... >±80°

Ritardo accensione: ..... 2 s Max

Capsula trasmittente: ..... microfono ad elettrete

Capsula ricevente: ..... altoparlante 45 Ω

Supporto per memoria esterna: ..... microSD standard (consigliata 2 GB)

Portata radio:

- all'interno di un'abitazione di 100m<sup>2</sup> con attraversamento perpendicolare di un muro maestro o di una soletta;
- 250m in aria libera.

*In entrambi i casi, riduzione della portata in presenza di elementi metallici, attraversamento di muri o paratie.*



Trasmissione radio: il led del trasmettitore si accende solo nel caso in cui la trasmissione sia andata a buon fine.  
In caso di portata insufficiente, l'aggiunta di ricevitore intermedio consente di risolvere il problema. Fare riferimento al libretto istruzioni dei trasmettitori Yokis.

Banda di frequenza:

WiFi: ..... 2400 ÷ 2483,5 MHz  
Yokis: ..... 2400 ÷ 2480 MHz  
Mifare: ..... 13,56 MHz

Potenza di uscita (Max):

WiFi: ..... 20 dBm  
Yokis: ..... 10 dBm  
Mifare: ..... -13 dBμA/m @ 10m





Uscita relè 1 (OP5 / OP5A) ..... 100 mA @ 24 V---  
Uscita relè 2 (OP20 - RELAY SPARE) ..... 25 mA @ 24 V---  
Temperatura di funzionamento: ..... -5 ÷ +45° C  
Umidità max: ..... 95% UR  
Dimensioni (LxAxP): ..... 202 x 142 x 22 mm

### Pulsantiera

Tensione di alimentazione: ..... 36÷48 V---  
Assorbimento: massimo ..... 130 mA @ 48 V---  
a riposo ..... 20 mA @ 48 V---  
Potenza massima assorbita in funzione: ..... max 6,5 W  
Dimensioni (LxAxP): ..... 100 x 180 x 28 mm  
Dimensioni cartellino portanome: ..... 48,5 x 15,5 mm  
Illuminazione cartellini e pulsanti: ..... LED bianchi  
Grado di protezione degli involucri: ..... IP45  
Grado di protezione contro impatti meccanici: ..... IK07  
Temperatura di funzionamento: ..... -10 ÷ +50° C  
Umidità max: ..... 95% UR  
Corrente massima contatto pulito N.O. (OP3): ..... 1 A @ 30 V---  
Capsula trasmettente: ..... microfono ad elettrete  
Capsula ricevente: ..... altoparlante 16 Ω resistente all'acqua

⚡ I cavi impiegati devono rispondere alla norma IEC 60332-1-2 se di sezione 0,5 mm<sup>2</sup> o superiore, oppure alla norma IEC 60332-2-2 se di sezione inferiore a 0,5 mm<sup>2</sup>.

## 11 LEGENDA SIMBOLI

Simbolo	Spiegazione
---	Tensione di alimentazione continua
~	Tensione di alimentazione alternata
	Marchio commerciale del sistema videocitofonico
	Alimentatore dotato di un doppio isolamento
	PERICOLO - Presenza di tensioni pericolose
	PERICOLO - Presenza di componenti critici per la sicurezza
	Riferirsi al manuale d'installazione del dispositivo

## 12 DICHIARAZIONE DI CONFORMITÀ UE SEMPLIFICATA

Il fabbricante, URMET S.p.A., dichiara che i tipi di apparecchiature radio:

**KIT VIDEOCITOFONICI A 2 FILI MONO E BIFAMILIARE CON RINVIO DI CHIAMATA**

con codici 1723/95 e 1723/96 sono conformi alla direttiva 2014/53/UE.

Il testo completo della dichiarazione di conformità UE è disponibile al seguente indirizzo Internet: [www.urmet.com](http://www.urmet.com)

1	GENERAL DESCRIPTION.....	23
2	KIT COMPOSITION.....	25
3	ACCESSORY DEVICES.....	27
4	SPARE PARTS.....	29
5	CONNECTION BLOCK CHART.....	29
5.1	ONE-HOUSEHOLD SYSTEM.....	29
5.1.1	Maximum distances between devices.....	29
5.2	TWO-HOUSEHOLD SYSTEM.....	30
5.2.1	Maximum distances between devices.....	30
6	WARNINGS FOR INSTALLERS.....	31
7	VIDEO DOOR PHONE INSTALLATION.....	32
7.1	DESCRIPTION OF COMPONENTS.....	32
7.2	INSTALLATION METHOD.....	33
7.3	TERMINAL BOARD DESCRIPTION.....	33
7.4	OUTDOOR CAMERA/RELAY 2 (OP20) CONNECTOR DESCRIPTION.....	34
7.5	RELAY FUNCTIONS AND CONFIGURATIONS.....	34
7.6	JUMPER CONFIGURATION (JP1 and JP2).....	34
7.7	DIP-SWITCH CONFIGURATION.....	34
7.7.1	Calling button to video door phone association.....	35
7.7.2	Video door phone code.....	35
7.7.3	System type.....	35
7.7.4	Audio activation by pressing button (“Push-to-talk” mode).....	35
7.7.5	Default settings:.....	35
8	SYSTEM POWER SUPPLY AND AUDIO VIDEO INDUCTOR INSTALLATION.....	36
8.1.1	Description of terminals.....	36
9	CONTROL PANEL INSTALLATION.....	37
9.1	DESCRIPTION OF COMPONENTS.....	37
9.2	INSTALLATION METHOD.....	38
9.3	DESCRIPTION OF TERMINALS.....	39
9.4	DIP-SWITCH CONFIGURATION.....	39
9.4.1	DOOR STATE or LETTERBOX function selection (indication of mail present in letterbox).....	39
9.4.2	Panel ID n.....	39
9.4.3	Camera LED switch-on during call.....	39
9.4.4	Apartment 0 call enabling from both button on panel (function available only with two-household kit ref. 1723/96).....	39
9.4.5	Pedestrian gate and garage gate lock activation type selection, capacitance discharge or dry relay.....	39
9.4.6	Panel type setting.....	40
9.4.7	Lock activation time adjustment with capacitance discharge.....	40
9.4.8	Default settings.....	40
9.5	SPEAKER VOLUME ADJUSTMENT.....	40
10	TECHNICAL SPECIFICATIONS.....	40
11	KEY TO SYMBOLS.....	41
12	SIMPLIFIED EU DECLARATION OF CONFORMITY.....	41
13	WIRING DIAGRAM.....	122
13.1	ONE-HOUSEHOLD KIT CONNECTION REF.1723/95 WITH 3 VIDEO DOOR PHONES IN PARALLEL.....	122
13.2	TWO-HOUSEHOLD KIT CONNECTION REF.1723/96 WITH 3 VIDEO DOOR PHONES IN PARALLEL FOR EACH USER.....	124
13.3	CONNECTION OF A SUPPLEMENTARY RINGER TO VIDEO DOOR PHONE.....	126
13.4	DIAGRAM KEY.....	127
13.5	NOTES ON DIAGRAMS.....	129

# 1 GENERAL DESCRIPTION

---

The NOTE2 video door phone system is easy to install. Only two non-polarised wires are needed to interconnect all system devices.

Modularity mean being able to implement various supplementary functions, in addition to the basic video door phone functions, offering solutions suited to all needs.

The features of the video door phone system are:

## System

- One-household kit ref. 1723/95:
  - Allows the use of two video door phones without any supplementary power supply.
  - Can manage up to four door phones (one Master and three Slaves) called in parallel, with in-out connection.
- Two-household kit ref. 1723/96:
  - Allows the use of two video door phones without any supplementary power supply, one per apartment.
  - Can manage up to eight door phones (two Masters and six Slaves) called in parallel, with column video distributor and floor in-out connection.
- Connection of all devices using only two non-polarised wires.
- Connection of the power supply in any point of the system between control panel and video door phone.
- Possibility of managing up to two automatically switching calling stations.
- Possibility of extending the length of the buses by means of additional device.
- Device configuration by means of jumpers and dip-switches.
- Connection to system by means of removable terminal boards.

## Panel

- Vandal-proof panel Mod. MIKRA2 with weatherproof zama front and one or more buttons.
- Installation on wall (standard), possibility of flush-mounted installation with dedicated kit.
- Wide-angle colour camera on panel with lighting of the subject by means of LED.
- MIFARE proximity key reader.
- Backlit white name holder tag.
- Pedestrian gate lock activation via capacitance discharge pulse and hold current, programmable activation time.
- Setup for connecting a hall button for locally operating the pedestrian gate electrical lock.
- Setup for connection of DOOR STATE or LETTERBOX function sensor.
- Activation of the pedestrian gate lock by approaching proximity keys provided to the panel.
- Garage gate lock control with dry relay.
- Call forward confirmation with auditory signalling and by switching name tag backlighting LEDs off.
- Camera LED switch-on during call with possibility of exclusion.
- Possibility of adjusting the panel speaker volume.
- Visual and auditory system state signals (DDA), function available with one-household panels only.
- Water-resistant integrated microphone.

## Apartment station

- Hands-free video door phone apartment stations Mod. VMODO with 7" LED colour and capacitive touchscreen.
- Installation on wall (standard), possibility of flush-mounted installation with dedicated kit.
- Multilingual user interface (IT, EN, FR, ES, DE, CS, NL, NO, PL, PT, SK, VLS).
- Hands-free or push-to-talk mode:
  - Hands-free: press the audio button once to start the conversation and once again to end it.
  - Push-to-talk: press the audio button to speak to the door unit, release the button to listen.
- Ring tones: Five standard plus one customisable by the user.
- Possibility of attributing various tones according to the origin of the call (from panel, intercom, floor call, alarm signal).
- Provided with:
  - Hearing-aid-compliant audio output device (ILA).
  - Two configurable relay outputs with dry contacts for activating auxiliary controls.

- Backlit touch buttons with red or green LEDs.
- Possibility of directly connecting to the video door phone:
  - One local CCTV camera, ref. 1092/250A.
  - One floor call button (only on Master).
  - One temperature sensor Yokis THERMPROBE (Cod. 5454488).
  - One alarm contact (only on Master).
- Possibility of connecting a supplementary ringer or wireless call repeater to each video door phone (French market only).
- Possibility of changing the image viewing ratio from 4:3 to 16:9.
- Possibility of adjusting the audio (speaker volume) and video (brightness, contrast and colour).
- Adjustable calling volume with possibility of muting.
- Possibility of muting button pressing auditory feedback;
- External memory medium: microSD (function possible only if the video door phone is installed on wall).
- Calendar and clock functions with two hours backup time in case of network blackout.
- Possibility of replacing the video door phone button front with one of a different colour.
- Staircase light switch-on setup using relay.
- Home Automation (Yokis) applications.
- Detection and adjustment of temperature inside the home (thermostat function) with optional temperature sensor.
- Possibility of indicating presence of mail in the letterbox (LETTERBOX function, available only on Master video door phone with optional devices).
- Indication by means of LEDs of: video door phone on, call or conversation in progress, mute on, Yokis radio module on, entrance door open, automatic door opening active, call forwarding function active, alarm on function, alarm in progress, presence of mail in the letterbox (LETTERBOX function), presence of new audio messages (POST-IT function), presence of new recorded video messages.
- Possibility of browsing the events log of access and alarm functions.

### Basic functions













- Video door phone call from door unit;
- Pedestrian and secondary (garage) gate lock activation only following call or auto-on function.
- Audio/video auto-on function on panel.
- Intercom call between single video door phones in the same apartment.
- Group intercom call to all video door phones belonging to the same apartment.
- Group intercom call between video door phones of different apartments (function available with kit ref. 1723/96 only).













### Additional functions

- Possibility of connecting up to four CCTV cameras in the system with a dedicated device.
- Cyclic auto-on function in automatic mode, by any video door phone, on calling stations, on its local camera and on the CCTV cameras present in the system.
- The following functions are possible on Master video door phones only:
  - Activate the call forwarding function for audio-video or audio-only calls to an Android or iOS smartphone or tablet.
  - Activating a video door phone answering service capable of recording up to 32 video messages, each 10s long.
  - Sending a pre-recorded audio message to the caller (maximum time 20s).
  - Activating a video-only recording synchronised with the call (up to 32 records, each 20s long).
- Possibility of recording short audio messages (POST-IT) on any video door phone in the system (max. 32 messages, each 20s long).
- Possibility of activating the pedestrian gate lock automatically following a call.
- Possibility of recording and storing video also on microSD card.
- Possibility of muting the microphone.
- Possibility of viewing date and time, with the additional diary function.
- Alarm detection:
  - Signalling with LED and generation of acoustic tone on video door phone.
  - Repeating the auditory indication on a siren.

















- Activating a camera for shooting images with automatic recording of a video message.
- Activation of Yokis radio modules from any video door phone.
- Scheduling of Yokis radio module activations for one or more weekly events.
- Call and/or alarm divert to smartphone, with dedicated device.
- Possibility of updating system firmware using the microSD card.















## 2 KIT COMPOSITION

Description		N	ID	
Panel (A)	Panel model MIKRA2 with 1 calling button (present only in kit ref. 1723/95)	1		A1
	Panel model MIKRA2 with 2 calling buttons (present only in kit ref. 1723/96)	1		A2
	Screws for fixing to wall (ø 3.5 x 32 mm)	4		A3
	Anchor bolts for fastening to wall (ø 5 mm)	4		A4
	Screwdriver insert (ø 2 mm)	1		A5
	Grey name tag (qty. 1 in kit ref. 1723/95, qty. 2 in kit ref. 1723/96)	1/2		A6
	Transparent name tag (qty. 1 in kit ref. 1723/95, qty. 2 in kit ref. 1723/96)	1/2		A7
	Spare Allen screw for closing the panel (M3 x 12 mm)	1		A8
	MIFARE master programming key	1		A9
	MIFARE transponder keys (qty. 5 in kit ref. 1723/95, qty. 10 in kit ref. 1723/96)	5/10		A10
	Chip tag (qty. 2 in kit ref. 1723/95, qty. 4 in kit ref. 1723/96)	2/4		A11
	Ferrite screen per chip tag (qty. 2 in kit ref. 1723/95, qty. 4 in kit ref. 1723/96)	2/4		A12
	Instruction booklet for chip tag (qty. 1 in kit ref. 1723/95, qty. 2 in kit ref. 1723/96)	1/2		A13

Apartment station (B)	Video door phone Mod. VMODO Master (qty. 1 in kit ref. 1723/95, qty. 2 in kit ref. 1723/96)	1/2		B1
	Bracket for fixing to wall (qty. 1 in kit ref. 1723/95, qty. 2 in kit ref. 1723/96)	1/2		B2
	Screws for fixing to wall (ø 2.9 x 32 mm) (qty. 4 in kit ref. 1723/95, qty. 8 in kit ref. 1723/96)	4/8		B3
	Anchor bolts for fastening to wall (ø 5 mm) (qty. 4 in kit ref. 1723/95, qty. 8 in kit ref. 1723/96)	4/8		B4
	Screws for fixing to flush-mounting box Mod. 503 (M3.5 x 19 mm) (qty. 2 in kit ref. 1723/95, qty. 4 in kit ref. 1723/96)	2/4		B5
	Lever for removing front panel from video door phone (qty. 1 in kit ref. 1723/95, qty. 2 in kit ref. 1723/96)	1		B6
	Six-pin wire for connecting optional devices (qty. 1 in kit ref. 1723/95, qty. 2 in kit ref. 1723/96)	1/2		B7
	Extractable terminal boards for connecting video door phone to system (qty. 2 in kit ref. 1723/95, qty. 4 in kit ref. 1723/96)	2/4		B8
	Two-pin wire for connecting an optional temperature sensor (qty. 1 in kit ref. 1723/95, qty. 2 in kit ref. 1723/96)	1/2		B9
Power supply unit (C)	System power supply unit	1		C1
	Audio video inductor	1		C2
(D)	Video distributor (only in kit ref. 1723/96)	1		D

### 3 ACCESSORY DEVICES

Description		Max. n. (maximum system configuration)	ID
Electric lock (12 V~ Max. 15 VA)	-	2 (one for each panel)	 OP1
Button for pedestrian gate electric lock	-	2 (one for each panel)	 OP2
Relay contacts for garage gate lock activation device (max. switching current 1 A @ 30 V)	-	2 (one for each panel)	 OP3
Open door sensor	Ref. 1033/701	2 (one for each panel)	 OP4 (*)
Radio ringer (available for the French market only)	Code 43410	12 (3 for each video door phone)	 OP5 (**)
Supplementary ringer (max. 4 with kit ref. 1723/95, max. 8 with kit ref. 1723/96)	Ref. 9854/43	4/8 (one for each video door phone)	 OP5A (**)
Supplementary "Slave" video door phones Mod. VMODO 7" hands-free (max. 3 with kit ref. 1723/95, max. 6 with kit ref. 1723/96)	Ref. 1723/97	3/6	 OP6
Magnetic alarm sensor	Ref. 1033/701	2 (one for each Master video door phone)	 OP7
Presence sensor (NC in absence of signalling)	Ref. 1033/012 Ref. 1033/132	4 (two for each Master video door phone)	 OP7a (#)
Floor call button	-	2 (one for each Master video door phone)	 OP8
One-household secondary panel Mod. MIKRA2	Ref. 1723/11	1	 OP9
Two-household secondary panel Mod. MIKRA2	Ref. 1723/12	1	 OP10
Access control panel	Ref. 1723/46	2 (one for each panel)	 OP11
Flush-mounting kit for panel	Ref. 1723/50	2 (one for each panel)	 OP12
Relay box for 2 panels	Ref. 1723/51	1	 OP13
Table stand for video door phone 7" hands-free (max. 4 if with kit ref. 1723/95, max. 8 if with kit ref. 1723/96)	Ref. 1723/52	4/8	 OP14
Flush-mounting kit for video door phone 7" hands-free (max. 4 if with kit ref. 1723/95, max. 8 if with kit ref. 1723/96)	Ref. 1723/60	4/8	 OP16

CCTV interface	Ref. 1723/69	1		
BALUN passive one-channel video device	Ref. 1092/300A	4 (one for each camera connected to the CCTV interface)		OP17
Mifare key kit	Ref. 1723/102	maximum 21 keys in the system		OP18
Compact AHD DAY & NIGHT camera with 3.6mm fixed lens (max. 4 if with kit ref. 1723/95, max. 8 if with kit ref. 1723/96)	Ref. 1092/250A	4/8 (one per video door phone)		OP19 (#)
BALUN passive one-channel video device	Ref. 1092/300A	4/8 (one for each camera ref. 1092/250A)		
Programmable output which can be activated: - after pressing the Home Automation button (default function: staircase lights) - following alarm event - by thermostat function.	-	-		OP20 (**)
Timed relay 2000W	Code 5454462	one per kit		
Relay with coil 230V~	Code 5454081	one per kit		
Two-channel transmitter for buttons Mod. E2BPP	Code 5454413	1 (only for kit ref. 1723/95)		OP21 (*)
Four-channel transmitter for buttons Mod. E4BPP	Code 5454427	2 (only for kit ref. 1723/96)		
Magnetic alarm sensor (qty. 2 with kit ref. 1723/95, qty. 4 with kit ref. 1723/96)	Ref. 1033/701	2/4		
Yokis THERMPROBE temperature sensor (max. 4 if with kit ref. 1723/95, max. 8 if with kit ref. 1723/96)	Code 5454488	4/8 (one for each video door phone)		OP22
Power supply unit for camera type ref. 1092/250A	Ref. 1092/800	4 (one for each camera in combination with CCTV interface ref. 1723/69)		OP23
Local transformer for 1723/97 (qty. 2 with kit ref. 1723/95, qty. 6 with kit ref. 1723/96)	Ref. 1723/22	2/6 (one for each Slave video door phone)		C4
Video distributor (present only in kit ref. 1723/96)	Ref. 1723/55	1		D







(\*) The two options are mutually exclusive.

(\*\*) For more information see paragraph 7.5 - RELAY FUNCTIONS AND CONFIGURATIONS

(#) The two options are mutually exclusive.



## 4 SPARE PARTS

Description	ID	Description	ID
System power supply unit	Ref. 1723/20  C1	"Master" 7" video door phone Mod. VMODO	Ref. 1723/98  B1
Audio video inductor	Ref. 1723/112  C2	MIKRA2 door panel with 1 calling button (only in kit Ref. 1723/95)	Ref. 1723/11  A1
Video distributor	Ref.. 1723/55  D	MIKRA2 door panel with 2 calling buttons (only in kit Ref. 1723/96)	Ref. 1723/12  A2

## 5 CONNECTION BLOCK CHART

### 5.1 ONE-HOUSEHOLD SYSTEM

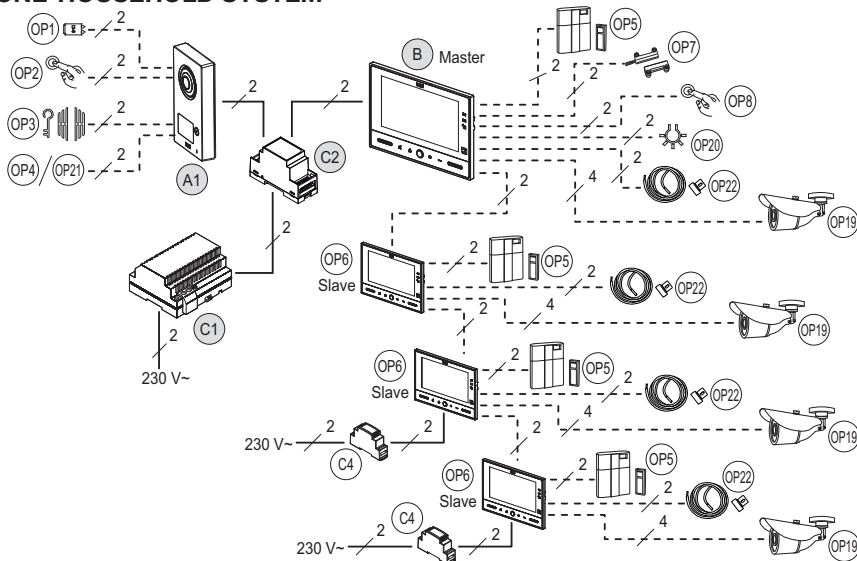

#### 5.1.1 Maximum distances between devices

Segment	Type of wire					
	SYT1-3P-AWG20 (Ø 0,8 mm)	Twisted telephone wire Ø 0.6 mm without sheath	CAT5	1,5 mm <sup>2</sup> single	2Voice	PTT278
A1 – C2	150 m	150 m	100 m	75 m	200 m	100 m
C1 – C2	0,5 m	0,5 m	0,5 m	0,5 m	0,5 m	0,5 m
C2 – most distant video door phone (OP6)	50 m	50 m	50 m	20 m	50 m	50 m
A – OP1	10 m	10 m	10 m	20 m	20 m	10 m
A – OP2	50 m	50 m	30 m	50 m	50 m	50 m
A – OP3	10 m	10 m	10 m	20 m	20 m	10 m
A – OP4	25 m	25 m	25 m	25 m	25 m	25 m
A – OP21	10 m	10 m	10 m	10 m	10 m	10 m
B – OP5	30 m	30 m	30 m	30 m	30 m	30 m
B – OP7	30 m	30 m	30 m	30 m	30 m	30 m
B – OP8	30 m	30 m	30 m	30 m	30 m	30 m
B – OP19	-	-	50 m	-	-	-
B – OP20	30 m	30 m	30 m	30 m	30 m	30 m
OP6 – C4	20 m	10 m	10 m	30 m	20 m	20 m
OP6 – OP5	30 m	30 m	30 m	30 m	30 m	30 m

 Wires with cross-section area of 0.5 mm<sup>2</sup> or larger must comply with IEC 60332-1-2; wires with cross-section area smaller than 0.5 mm<sup>2</sup> must comply with IEC 60332-2-2.

## 5.2 TWO-HOUSEHOLD SYSTEM

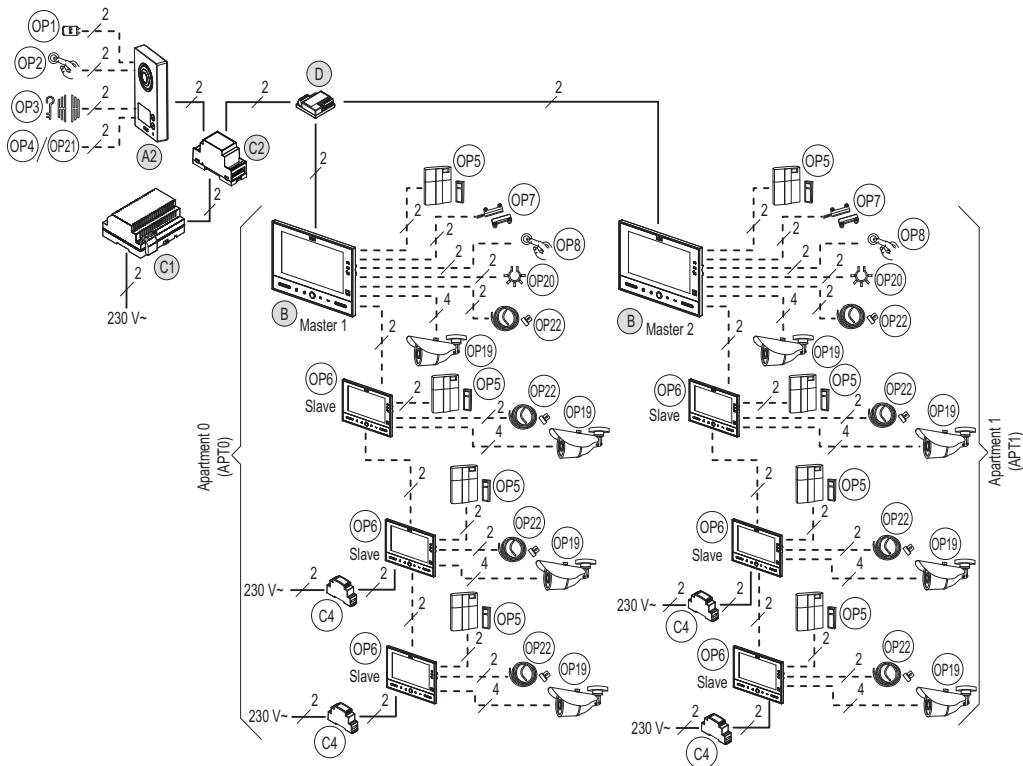

### 5.2.1 Maximum distances between devices

Segment	Type of wire					
	SYT1-3P-AWG20 (Ø 0,8 mm)	Twisted telephone wire Ø 0.6 mm without sheath	CAT5	1,5 mm <sup>2</sup> single	2Voice	PTT278
A2 – C2	150 m	150 m	100 m	75 m	200 m	100 m
C1 – C2	0,5 m	0,5 m	0,5 m	0,5 m	0,5 m	0,5 m
C2 – D	5 m	5 m	5 m	5 m	5 m	5 m
C2 – most distant video door phone (OP6)	50 m	50 m	50 m	20 m	50 m	50 m
A – OP1	10 m	10 m	10 m	20 m	20 m	10 m
A – OP2	50 m	50 m	30 m	50 m	50 m	50 m
A – OP3	10 m	10 m	10 m	20 m	20 m	10 m
A – OP4	25 m	25 m	25 m	25 m	25 m	25 m
A – OP21	10 m	10 m	10 m	10 m	10 m	10 m
B – OP5	30 m	30 m	30 m	30 m	30 m	30 m
B – OP7	30 m	30 m	30 m	30 m	30 m	30 m
B – OP8	30 m	30 m	30 m	30 m	30 m	30 m
B – OP19	-	-	50 m	-	-	-
B – OP20	30 m	30 m	30 m	30 m	30 m	30 m
OP6 – C4	20 m	10 m	10 m	30 m	20 m	20 m
OP6 – OP5	30 m	30 m	30 m	30 m	30 m	30 m

Wires with cross-section area of 0.5 mm<sup>2</sup> or larger must comply with IEC 60332-1-2; wires with cross-section area smaller than 0.5 mm<sup>2</sup> must comply with IEC 60332-2-2.

## 6 WARNINGS FOR INSTALLERS

---

Read the notes in this manual carefully. This manual contains important information on safe installation, use and maintenance.

- This devices in the kit must only be put to the use for which they were intended. All other use is improper. The manufacturer cannot be held responsible for damage deriving from improper, incorrect or unreasonable use.
- Each part was designed to be compliant with the standards in force.
- The system must be built in compliance with the regulations in force. All devices in the system must be exclusively used for the purpose for which they were designed.
- Remove the components from the packaging and check that they are intact.
- Keep the packaging (plastic bags, polystyrene, etc.) away from children. Packaging is potentially dangerous.
- Provide a suitable cut-off and protection master switch upstream from the devices, with contacts open by at least 3 mm.
- Make sure that the plate data corresponds to the power specifications before connecting the devices to the mains.
- Keep the ventilation or cooling openings and slots free.
- Disconnect the devices from the mains before cleaning or maintenance.
- Do not use spray products to clean the device.
- Disconnect power from the circuit breaker in the event of failure and/or malfunctioning of the products contained in the kit. Do not tamper with the devices.
- Exclusively contact a service centre authorised by the manufacturer for repairs.
- Provide suitable ventilation.
- Do not use power extension wires.
- Have the device checked and repaired by qualified personnel in the case of infiltration of fluid or objects inside the device.
- Exclusively use the spare parts supplied by the manufacturer for repairs.
- Installers must make sure that user's information is applied to the connected devices.
- Disrespect of these precautions can effect safety of the devices.
- Keep this manual with the device at all times.
- The lightening symbol in a equilateral triangle indicates the presence of dangerous voltage.



- Never open the devices unless expressly instructed to do so in this instruction manual.
- The exclamation mark symbol in an equilateral triangle indicates critical safety components. Always only use components supplied by the manufacturer.



# 7 VIDEO DOOR PHONE INSTALLATION

## 7.1 DESCRIPTION OF COMPONENTS

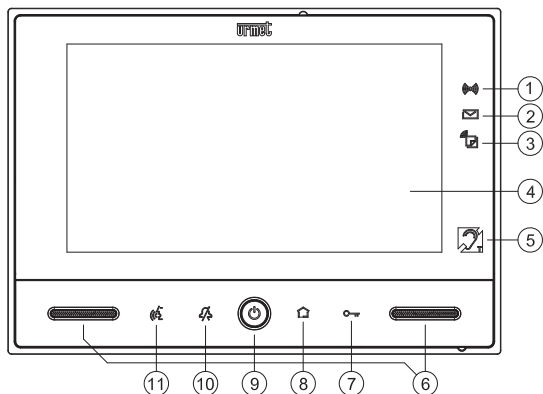

### Front panel:

1. Alarm icon
2. Mail in letterbox indication icon (LETTERBOX function)
3. Answering service active indication icon (fixed green) / Audio message POST-IT present (red blinking) / call forwarding function active (fixed yellow) (master video door phone Ref. 1723/98 only).
4. 7" display
5. Icon indicating that the video door phone is hearing-aid compatible (ILA)
6. Speakers
7. Door opening button (touch)
8. Yokis command reception confirmation icon
9. ON/OFF button
10. MUTE button (touch)
11. Audio on button (touch)

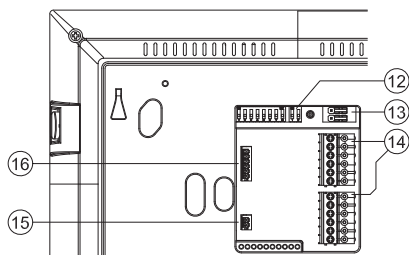

### Rear part:

12. Configuration dip-switch:
13. Jumpers
14. Extractable six-pin terminal boards
15. Two-way connector for external thermostat
16. Six-pin connector for connecting external camera/relay 2 (OP20)

## 7.2 INSTALLATION METHOD

- Fix the bracket to the wall using a box 503 and the screws provided or a Ø 60 mm box with suitable screws.
- Program the dip-switches and connect the system wires to the terminal boards.
- Couple the video door phone to the bracket at the four hooks on the sides.
- Remove the protective film from the display.

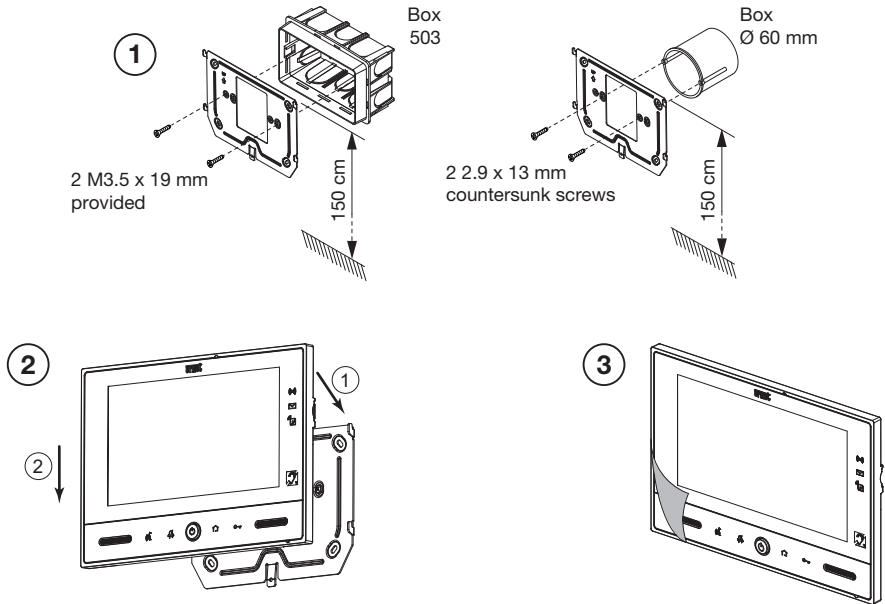

 Remove the protective film from the video door phone display.

## 7.3 TERMINAL BOARD DESCRIPTION

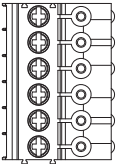
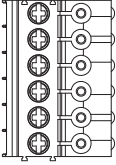
Terminal board	Terminal name	Description
	LI	Bus input (LINE IN)
	LI	
	LO	Bus output (LINE OUT)
	LO	
	LP	24V~ local power
	LP	
	FC	Floor call
	FC	Floor call
	0	Supplementary ringer (output relay 1 – OP5 / OP5A)
	C	
	AL	Alarm sensor input
	AL	

## 7.4 OUTDOOR CAMERA/RELAY 2 (OP20) CONNECTOR DESCRIPTION

The outdoor camera ref. 1092/250A can be connected to the Master video door phone using the wire (B7) provided.

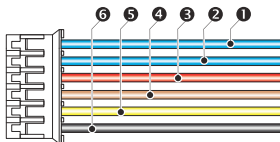

Wire n.	Wire colour	Description	Pin name on connector
1	Blue	Staircase lights (relay output 2 – OP20)	RELAY SPARE
2	Blue	Staircase lights (relay output 2 – OP20)	RELAY SPARE
3	Red	Camera power positive	CCTV POWER+
4	Brown	Video balun negative output signal	CCTV VIDEO-
5	Yellow	Video balun positive output signal	CCTV VIDEO+
6	Black	Camera power negative	CCTV POWER-

## 7.5 RELAY FUNCTIONS AND CONFIGURATIONS

The video door phone is provided with two programmable relays, as shown in the following table:

Relays	Possible function	Default	Riference
1	Supplementary ringer	✓	OP5 / OP5A
	Home Automation button 1		
	Siren alarm		
2	Home Automation button 2	✓	OP20
	Siren alarm		
	Thermostat output		

## 7.6 JUMPER CONFIGURATION (JP1 and JP2)

There are two jumpers on the video door phone:

- JP1: this is used to insert the line termination. The line termination must be activated on the video door phone connected to the end of a line which is not resumed with another segment from the LINE OUT terminals.

	JP1
Terminal insert (default)	
Terminal not inserted	

- JP2: this is used to power the video door phone from the Bus line or via a local transformer ref. 1723/22.



	JP2
Bus light power supply (default)	
Power from local transformer	

## 7.7 DIP-SWITCH CONFIGURATION

The video door phone has 8 dip-switches on the back of the device.



⚡ Dip-switches 5, 7 and 8 are not used.

### 7.7.1 Calling button to video door phone association

	Dip-switch 1 position		Dip-switch 1 position
Video door phone associated with calling button 0 (upper)		Video door phone associated with calling button 1 (lower)	

### 7.7.2 Video door phone code

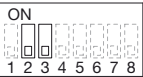
Set the respective code using the dip-switches 2 and 3 on each apartment station to install Slave video door phones.

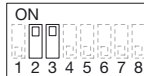

Video door phone type	Dip-switch 2 and 3 position	Video door phone type	Dip-switch 2 and 3 position
Master video door phone		Slave 1 video door phone	
Slave 2 video door phone		Slave 3 video door phone	

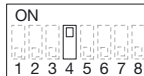
### 7.7.3 System type

	Dip-switch 4 position		Dip-switch 4 position
One-household system		Two-household system	

### 7.7.4 Audio activation by pressing button (“Push-to-talk” mode)

If the communication between the door panel and the video door phone is disturbed or absent, check that the transparent film covering the video door phone display has been removed. If the film was removed and the audio is still disturbed, try to activate the two audio channels (from the outside in and from the inside out) one at a time.

After having received a call, briefly press  to activate the control panel audio; afterwards, hold the button pressed  to activate the audio channel towards the outside and speak to the caller. Release the button  to listen.

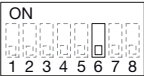
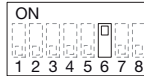
	Dip-switch 6 position		Dip-switch 6 position
Function off		Function on	

### 7.7.5 Default settings

<b>One-household kit ref. 1723/95:</b>	Video door phone	
<b>Two-household kit ref. 1723/96:</b>	Video door phone 1	
	Video door phone 2	

## 8 SYSTEM POWER SUPPLY AND AUDIO VIDEO INDUCTOR INSTALLATION

The power supply unit must be installed in the electric panel or a cabinet.

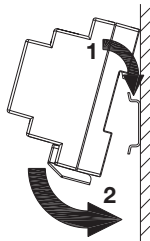

Installation on DIN bar (6 modules, 18 mm)

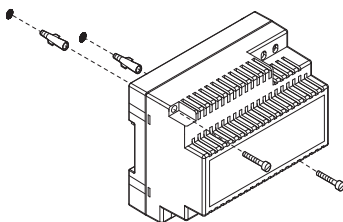

Wall-mounted installation

The electronic inductor module may be fixed to the wall by means of bracket supply in the kit or fixed to DIN bar (2 modules, 18 mm each).

The electronic inductor module must be installed in the same electric panel as the power supply unit.

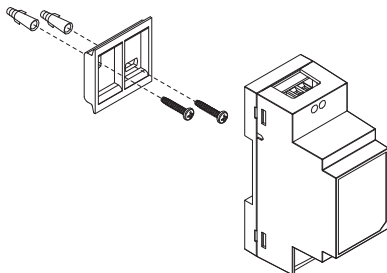

### 8.1.1 Description of terminals

#### System power supply ref. 1723/20

- ⊗ 110-230V~ / N Mains power voltage input 110-230 V~
- ⊗ + } Power voltage output
- ⊗ - }

#### Audio video inductor ref. 1723/112

- ⊗ + } Power voltage input
- ⊗ - }
- ⊗ ] LINE1 BUS line 1
- ⊗ ] LINE2 BUS line 2



## 9 CONTROL PANEL INSTALLATION

### 9.1 DESCRIPTION OF COMPONENTS

Panel Mod. MIKRA2 with 1 calling button  
(present only in one-household kit ref. 1723/95)

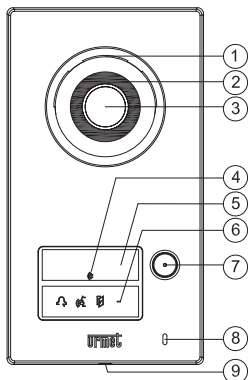

Panel Mod. MIKRA2 with 2 calling buttons  
(present only in two-household kit ref. 1723/96)

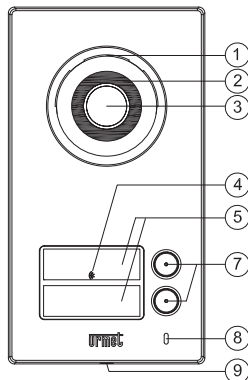

Front panel:

1. Speaker
2. Camera lighting LED
3. Camera
4. Transponder reader
5. Name tag(s)
6. Signalling LEDs dedicated to the DDA function
7. Calling button(s)
8. Microphone
9. Front closing screw

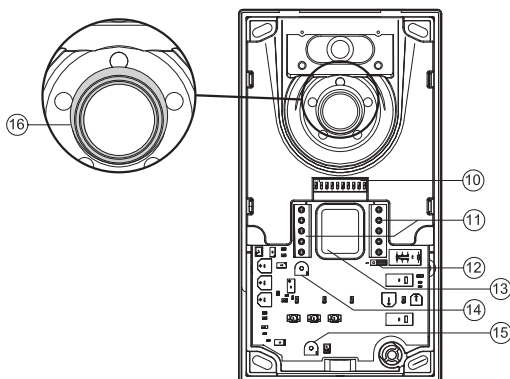

Inside:

10. Configuration dip-switch:
11. Terminal boards
12. **Do not change the position of this jumper!**
13. Hole for running wires
14. Speaker volume trimmer
15. **Do not turn this trimmer!**
16. Anti-reflection seal

## 9.2 INSTALLATION METHOD

- Install the panel at the indicated heights checking that the caller is framed by the camera.
- Connect the wires to the terminal boards.
- Fit the name tags on the front.
- Program the device.
- If necessary, adjust the speaker volume.
- Close the metal lid of the panel.
- Remove the protective films.

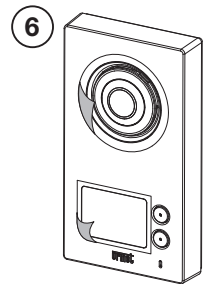
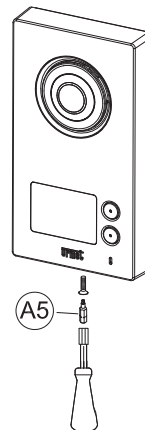
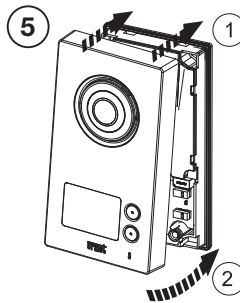
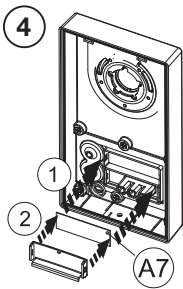
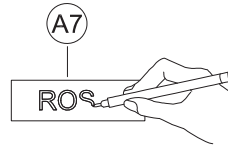
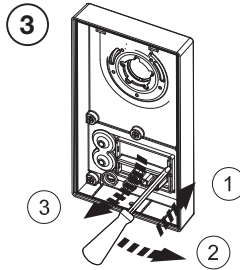
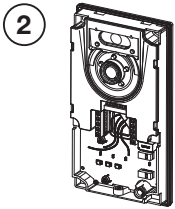
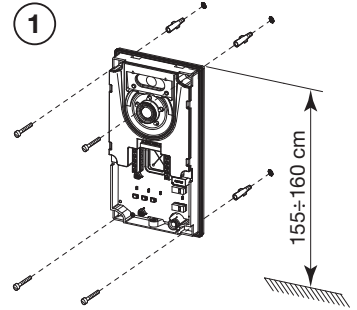
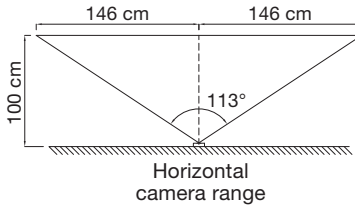
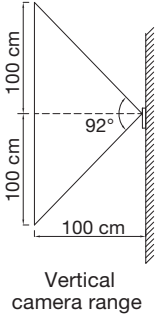

### 9.3 DESCRIPTION OF TERMINALS

#### Left terminal board

- ⊘ SE- Electrical lock with capacitance discharge actuation negative
- ⊘ SE+ Electrical lock with capacitance discharge actuation positive
- ⊘ } PA Input for pedestrian gate electric lock button
- ⊘ SP Input for DOOR STATE or LETTERBOX function sensor

#### Right terminal board



- ⊘ SP Input for DOOR STATE or LETTERBOX function sensor
- ⊘ } LINE Bus line
- ⊘ } N.O. Door opener dry actuation (OP3)

### 9.4 DIP-SWITCH CONFIGURATION



The video door phone has 10 dip-switches positioned inside the device.

⚡ ***Dip-switches 6, 9 and 10 must not be changed.***



#### 9.4.1 DOOR STATE or LETTERBOX function selection (indication of mail present in letterbox)

	Dip-switch 1 position		Dip-switch 1 position
DOOR STATE function on		LETTERBOX function on	



#### 9.4.2 Panel ID n.

	Dip-switch 2 position		Dip-switch 2 position
Panel 1		Panel 2	



#### 9.4.3 Camera LED switch-on during call

	Dip-switch 3 position		Dip-switch 3 position
Function on		Function off	



#### 9.4.4 Apartment 0 call enabling from both button on panel (function available only with two-household kit ref. 1723/96)

	Dip-switch 4 position		Dip-switch 4 position
Function off		Function on	



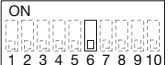

#### 9.4.5 Pedestrian gate and garage gate lock activation type selection, capacitance discharge or dry relay

	Dip-switch 5 position		Dip-switch 5 position
<u>Pedestrian gate lock activation by means of capacitance pulse discharge and hold current (SE+ and SE- terminals).</u> <u>Garage gate activation by means of dry contact relay (N.O. terminals).</u>		<u>Pedestrian gate lock activation by means of dry contact relay (N.O. terminals).</u> <u>Garage gate activation by means of capacitance pulse discharge and hold current (SE+ and SE- terminals).</u>	

### 9.4.6 Panel type setting

	Dip-switch 6 position		Dip-switch 6 position
One-household panel		Two-household panel	

### 9.4.7 Lock activation time adjustment with capacitance discharge

	Dip-switch 7-8 position		Dip-switch 7-8 position
0 seconds (300ms pulse)		3 seconds	
6 seconds		9 seconds	

### 9.4.8 Default settings

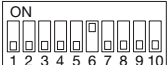
One-household kit ref. 1723/95:	Panel 1	
Two-household kit ref. 1723/96:	Panel 2	

## 9.5 SPEAKER VOLUME ADJUSTMENT

Volumes are calibrated by default so not to require adjustments in most cases.

Use a screwdriver to adjust the speaker volume, if required (see item 14 in paragraph 9.1 - DESCRIPTION OF COMPONENTS).

## 10 TECHNICAL SPECIFICATIONS

### System power supply unit

Power supply in CAT III 4000 V

Power supply: ..... 110-230 V~ 50-60 Hz  
 Power: ..... 75 W max  
 Secondary output: ..... 50 V--- 1 A  
 Working power after 1 hour of work: ..... Max 5 Wh (18 kJ)  
 Dimensions (WxHxD): ..... 108 (6 DIN modules) x 90 x 61 mm

### Audio video inductor

Dimensions (WxHxD): ..... 36 (2 DIN modules) x 95 x 57 mm

### Video door phone

Power voltage: ..... from BUS 37-48 V---  
 From local transformer 24V~ (+-10%)  
 Consumption: maximum ..... 280 mA @ 48 V---  
 stand-by (basic configuration) ..... 25 mA @ 48 V---  
 Working power: ..... max. 16 W  
 LCD: ..... 7" IPS backlight  
 Resolution: ..... 1024H x 600V pixel  
 Viewing angle ..... >±80°  
 Switch-on delay: ..... 2 s Max  
 Transmitting capsule: ..... electret microphone  
 Receiving capsule: ..... 45 Ω speaker  
 External memory medium: ..... standard microSD (recommended 2 GB)  
 Radio range:
 

- in a 100m<sup>2</sup> home with perpendicular crossing of main wall or ceiling
- 250m in open range.

*In both cases the range may be reduced by the presence of metallic elements, crossing of walls or partitions*

Radio transmission: the transmitter LED lights up only if the radio transmission was successful. Adding an intermediate receiver will solve the problem of insufficient range. Refer to the Yokis transmitter instruction booklet for more information.

Frequency band:

WiFi: ..... 2400 ÷ 2483,5 MHz  
 Yokis: ..... 2400 ÷ 2480 MHz  
 Mifare: ..... 13,56 MHz

Output power (Max):

WiFi: ..... 20 dBm  
 Yokis: ..... 10 dBm  
 Mifare: ..... -13 dBµA/m @ 10m

Relay output 1 (OP5 / OP5A) ..... 100 mA @ 24 V---

Relay output 2 (OP20 - RELAY SPARE) ..... 25 mA @ 24 V---

Working temperature range: ..... -5 to +45° C

Max. humidity: ..... 95% RH

Dimensions (WxHxD): ..... 202 x 142 x 22 mm

### Panel

Power voltage: ..... 36 to 48 V---

Consumption: maximum ..... 130 mA @ 48 V---

standby ..... 20 mA @ 48 V---

Maximum working power: ..... max. 6.5 W

Dimensions (WxHxD): ..... 100 x 180 x 28 mm

Name tag dimensions: ..... 48.5 x 15.5 mm

Tag and button light: ..... White LEDs

Degree of protection of casings: ..... IP45

Degree of protection from mechanical shocks: ..... IK07

Working temperature range: ..... -10 to +50° C

Max. humidity: ..... 95% RH





N.O. dry contact maximum current (OP3): ..... 1 A @ 30 V---

Transmitting capsule: ..... electret microphone

Receiving capsule: ..... 16 Ω water-resistant speaker

 Wires with cross-section area of 0.5 mm<sup>2</sup> or larger must comply with IEC 60332-1-2; wires with cross-section area smaller than 0.5 mm<sup>2</sup> must comply with IEC 60332-2-2.

## 11 KEY TO SYMBOLS

Symbol	Description
---	Direct input voltage
~	Alternating input voltage
	Video door phone system trademark
	Power supply fitted with double insulator
	DANGER - Presence of dangerous voltages
	DANGER - Presence of safety-critical components
	See the installation manual of the device

## 12 SIMPLIFIED EU DECLARATION OF CONFORMITY

Hereby, URMET S.p.A. declares that the radio equipment types:

**ONE- AND TWO-FAMILY 2-WIRE KIT WITH CALL FORWARDING FUNCTION**

(Ref. 1723/95 and 1723/96) are in compliance with Directive 2014/53/EU.

The full text of the EU declaration of conformity is available at the following internet address: [www.urmet.com](http://www.urmet.com)

DS1723-050A

## SOMMAIRE

1	DESCRIPTION GENERALE.....	43
2	COMPOSITION DU KIT .....	45
3	ACCESSOIRES .....	47
4	PIECES DETACHEES .....	49
5	SYNOPTIQUES DE CONNEXION .....	49
5.1	INSTALLATION MONO-FAMILLE .....	49
5.1.1	Distances maximales entre les dispositifs .....	49
5.2	INSTALLATION BI-FAMILLE .....	50
5.2.1	Distances maximales entre les dispositifs .....	50
6	AVERTISSEMENTS POUR L'INSTALLATEUR.....	51
7	INSTALLATION DU MONITEUR .....	52
7.1	DESCRIPTION DES COMPOSANTS.....	52
7.2	MODALITES D'INSTALLATION.....	53
7.3	DESCRIPTION DES BORNES.....	53
7.4	DESCRIPTION DU CONNECTEUR POUR LA CAMERA EXTERNE / RELAIS 2 (OP20) .....	54
7.5	FONCTIONS ET CONFIGURATIONS DES RELAIS.....	54
7.6	CONFIGURATION DES CAVALIERS (JP1 et JP2) .....	54
7.7	CONFIGURATION DES COMMULATEURS.....	54
7.7.1	Association bouton d'appel/moniteur.....	55
7.7.2	Code du moniteur .....	55
7.7.3	Typologie d'installation .....	55
7.7.4	Activation de la phonie en appuyant sur la touche (mode "Push to talk").....	55
7.7.5	Paramètres d'usine : .....	55
8	INSTALLATION DE L'ALIMENTATION SYSTEME ET DE L'INDUCTANCE AUDIO/VIDÉO .....	56
8.1.1	Description des bornes .....	56
9	INSTALLATION DE LA PLAQUE DE RUE.....	57
9.1	DESCRIPTION DES COMPOSANTS.....	57
9.2	MODALITES D'INSTALLATION.....	58
9.3	DESCRIPTION DES BORNES.....	59
9.4	CONFIGURATION DES COMMULATEURS.....	59
9.4.1	Sélection de la fonction ETAT PORTE ou LETTERBOX (signal de présence de courrier dans la boîte aux lettres) .....	59
9.4.2	N. d'identification de la plaque de rue .....	59
9.4.3	Allumage des diodes de la caméra en cas d'appel .....	59
9.4.4	Validation de l'appel de l'appartement 0 à l'aide des deux boutons de la plaque .....	59
9.4.5	Sélection du type d'activation de la serrure électrique pour piétons et d'accès véhicules, à décharge capacitive ou par relais à contact sec.....	59
9.4.6	Configuration du type de plaque.....	60
9.4.7	Réglage de la durée d'activation de la serrure électrique à décharge capacitive .....	60
9.4.8	Paramètres d'usine .....	60
9.5	REGLAGE DU NIVEAU PHONIQUE DU HAUT-PARLEUR.....	60
10	CARACTERISTIQUES TECHNIQUES .....	60
11	LÉGENDES SYMBOLES.....	61
12	DECLARATION UE DE CONFORMITE SIMPLIFIEE .....	61
13	SCHEMAS DE RACCORDEMENT.....	122
13.1	RACCORDEMENT DU KIT MONO-FAMILLE REF. 1723/95 AVEC 3 MONITEURS EN PARALLELE.....	122
13.2	RACCORDEMENT DU KIT BI-FAMILLE REF. 1723/96 AVEC 3 MONITEURS EN PARALLELE POUR CHAQUE APPARTEMENT .....	124
13.3	RACCORDEMENT DE LA SONNERIE SUPPLÉMENTAIRE AU MONITEUR .....	126
13.4	LEGENDE DES SCHEMAS .....	127
13.5	REMARQUES CONCERNANT LES SCHÉMAS .....	129

# 1 DESCRIPTION GENERALE

Les kits vidéo NOTE 2 sont caractérisés par une grande simplicité d'installation, grâce à l'utilisation de seulement 2 fils non polarisés pour l'interconnexion de tous les dispositifs du système.

Leur modularité permet d'ajouter d'autres fonctions, en plus de celles de base du système de vidéoportier, en offrant ainsi des solutions ciblées pour chaque exigence.

Le kit vidéo possède les caractéristiques suivantes :

## Systeme

- Kit mono-famille réf. 1723/95 :
  - Permet d'utiliser deux moniteurs sans aucune alimentation supplémentaire ;
  - Possibilité de gérer jusqu'à 4 moniteurs (1 "Maître" et 3 "Esclaves") appelés en parallèle, avec connexion entrée-sortie ;
- Kit bi-famille réf. 1723/96:
  - Permet d'utiliser deux moniteurs (un par appartement), sans aucune alimentation supplémentaire ;
  - Possibilité de gérer jusqu'à 8 moniteurs (2 "Maîtres" et 6 "Esclaves") appelés en parallèle, avec distributeur vidéo et connexion entrée-sortie dans l'appartement ;
- Raccordement de tous les dispositifs à l'aide de seulement 2 fils non polarisés ;
- Branchement de l'alimentation à n'importe quel endroit de l'installation, entre la plaque et le moniteur ;
- Possibilité de gérer jusqu'à 2 plaques d'appel en commutation automatique ;
- Possibilité d'augmenter la longueur des bus à l'aide d'un dispositif supplémentaire ;
- Configuration des dispositifs à l'aide de cavaliers et de commutateurs ;
- Connexions avec l'installation à l'aide de borniers extractibles.

## Plaque de rue

- Plaque de rue anti-vandalisme modèle MIKRA2 avec façade en zamak, résistante aux agents atmosphériques, avec une ou deux boutons ;
- Installation en saillie (standard), possibilité d'installation encastrée avec kit dédié ;
- Caméra de la plaque couleur, avec un grand angle de vue et éclairage du visiteur par diodes ;
- Lecteur de clé de proximité MIFARE ;
- Etiquette de nom rétro-éclairée, blanche ;
- Activation de la serrure électrique pour piétons par charge capacitive à impulsion et courant de maintien, avec temps d'activation programmable ;
- Pré-câblage pour le raccordement d'un bouton hall d'entrée pour l'activation locale de la serrure électrique pour piétons ;
- Pré-câblage pour le raccordement d'un capteur réservé à la fonction ETAT PORTE ou LETTERBOX (BOITE AUX LETTRES) ;
- Activation de la serrure électrique pour piétons en présentant les clés de proximité (livrées de série) sur la plaque de rue ;
- Commande de l'accès véhicules par relais à contact sec ;
- Confirmation d'envoi de l'appel par signal sonore et extinction des diodes de rétro-éclairage de l'étiquette ;
- Allumage des diodes de la caméra lors de l'appel, avec possibilité d'exclusion ;
- Possibilité de régler le niveau phonique du haut-parleur de la plaque de rue ;
- Signalisation visuelle et sonore de l'état de l'installation par pictogrammes lumineux (fonction uniquement disponible avec la plaque mono-famille) ;
- Microphone étanche intégré.

## Moniteurs

- Postes internes vidéo mains-libres modèle VMODO, écran couleur LCD 7" tactile ;
- Installation en saillie (standard), possibilité d'installation encastrée avec kit dédié ;
- Interface utilisateur disponible en plusieurs langues (IT, EN, FR, ES, DE, CS, NL, NO, PL, PT, SK, VLS)
- Modalité de conversation mains-libres ou par pression de la touche (mode "Push to talk") :
  - Mains-libres : en appuyant sur la touche de phonie, l'on active la conversation ; une deuxième action sur la touche désactive la conversation ;
  - Push to talk : en maintenant la touche de phonie enfoncée, il est possible de parler depuis le poste interne ; pour écouter, il suffit de relâcher la touche ;

- Sonnerie d'appel : 5 standard + 1 personnalisable par l'utilisateur ;
- Possibilité d'attribuer des sonneries différentes en fonction de la provenance de l'appel (plaque, intercom, appel palier, alarme) ;
- Avec :
  - Dispositif de répétition de la phonie pour malentendants (boucle magnétique) ;
  - Deux sorties configurables avec des relais à contact sec pour l'activation des commandes auxiliaires ;
  - Rétro-éclairage des boutons avec diodes rouge ou verte ;
- Possibilité de brancher directement au moniteur :
  - Une caméra de surveillance locale réf. 1092/250A ;
  - Un bouton de sonnette palière (seulement sur le Maître) ;
  - Une sonde de température Yokis THERMPROBE (Cod. 5454488) ;
  - Un contact d'alarme (seulement sur le Maître) ;
- Possibilité de brancher à chaque moniteur, pour la répétition de l'appel, une sonnerie supplémentaire ou un répéteur d'appel sans fil (uniquement pour le marché français) ;
- Possibilité de modifier le rapport d'affichage de l'image de 4:3 à 16:9 ;
- Possibilité de régler le son (volume haut-parleur) et l'image (luminosité, contraste et couleur) ;
- Volume d'appel réglable avec possibilité de coupure (fonction "mute") ;
- Signal sonore de confirmation de touche enfoncée, avec possibilité d'exclusion ;
- Support pour mémoire externe : microSD (uniquement si le moniteur est installé en apparent) ;
- Fonctions calendrier et horloge avec une autonomie de 2 heures en cas de panne de courant ;
- Possibilité de remplacer la façade des touches du moniteur par une autre d'une couleur différente ;
- Pré-câblage pour l'allumage de l'éclairage d'escalier par relais ;
- Applications de domotique (Yokis) ;
- Détection et réglage de la température à l'intérieur de l'habitation (fonction thermostat) avec sonde de température en option ;
- Possibilité de signaler la présence de courrier dans la boîte aux lettres (fonction LETTERBOX, uniquement disponible pour le moniteur Maître avec des dispositifs en option) ;
- Signalisation par diodes de : moniteur allumé, appel ou conversation en cours, fonction mute activée, activation du module radio Yokis, porte d'entrée restée ouverte, ouverture de porte automatique activée, fonction renvoi d'appel active, fonction alarme activée, alarme en cours, présence de courrier dans la boîte aux lettres (fonction LETTERBOX), présence de nouveaux messages audio (POST-IT), présence de vidéos enregistrés ;
- Possibilité de consulter l'historique d'événements des fonctions de contrôle des accès et d'alarme.

### Fonctions de base

- Appel du moniteur depuis un poste externe ;
- Activation de la serrure électrique pour piétons et de la deuxième porte (accès véhicules) uniquement à la suite d'un appel ou d'une activation automatique ;
- Fonction activation automatique audio/vidéo sur la plaque ;
- Appel intercom entre les différents moniteurs à l'intérieur du même appartement ;
- Appel intercom de groupe vers tous les moniteurs d'un même appartement ;
- Appel intercom de groupe entre des moniteurs d'appartements différents (fonction uniquement disponible avec le kit réf. 1723/96).













### Fonctions supplémentaires













- Possibilité de brancher jusqu'à un maximum de 4 caméras de surveillance à l'aide d'un dispositif dédié ;
- Fonction activation automatique cyclique par n'importe quel moniteur, sur les postes d'appel, sur la caméra locale ou sur les caméras de surveillance présentes dans l'installation ;
- Uniquement sur le moniteur Maître, il est possible :
  - La fonction renvoi d'appel permet de transférer un appel audio-vidéo, ou audio uniquement, vers un smartphone avec système d'exploitation Android ou iOS ;
  - D'activer une mémorisation d'images, capable d'enregistrer jusqu'à un maximum de 32 vidéos de 10 s ;
  - De diffuser un message audio pré-enregistré vers l'appelant (durée maximum : 20 s) ;
  - D'activer un enregistrement vidéo synchrone avec l'appel (jusqu'à un maximum de 32 enregistrements de 20 s) ;
- Possibilité d'enregistrer de brefs messages audio (POST-IT) sur n'importe quel moniteur de l'installation (maximum 32 messages de 20 s) ;



















- Possibilité d'activer la serrure électrique pour piétons en mode automatique suite à un appel ;
- Possibilité de sauvegarder les vidéos, y compris sur carte microSD ;
- Possibilité de coupure du microphone ;
- Possibilité d'afficher la date et l'heure, avec fonction agenda supplémentaire ;
- Détection d'une alarme :
  - Signalisation par diodes et émission d'une tonalité sur le moniteur ;
  - Répétition du signal sonore par une sirène ;
  - Activation d'une caméra pour filmer les images, avec enregistrement automatique d'une vidéo ;
- Activation de modules radio Yokis depuis n'importe quel moniteur ;
- Programmation des activations des modules radio Yokis une ou plusieurs fois par semaine ;
- Transfert de l'appel et/ou de l'alarme vers un smartphone, avec un dispositif dédié ;
- Possibilité d'actualiser le firmware du système via la carte microSD.

















## 2 COMPOSITION DU KIT

Description		Q	ID	
Plaque (A)	Plaque modèle MIKRA2 avec 1 touche d'appel (uniquement dans le kit réf. 1723/95)	1		A1
	Plaque modèle MIKRA2 avec 2 touches d'appel (uniquement dans le kit réf. 1723/96)	1		A2
	Vis de fixation murale (ø 3,5 x 32 mm)	4		A3
	Cheilles de fixation murale (ø 5 mm)	4		A4
	Embout 6 pans pour tournevis (ø 2 mm)	1		A5
	Etiquette porte-nom grise (1 dans le kit réf. 1723/95, 2 dans le kit réf. 1723/96)	1/2		A6
	Etiquette de nom transparente (1 dans le kit réf. 1723/95, 2 dans le kit réf. 1723/96)	1/2		A7
	Vis à six pans de rechange pour la fermeture de la plaque (M3 x 12mm)	1		A8
	Clé Maître MIFARE de programmation	1		A9
	Badges de proximité MIFARE (5 dans le kit réf. 1723/95, 10 dans le kit réf. 1723/96)	5/10		A10
	Puces discrètes (2 dans le kit réf. 1723/95, 4 dans le kit réf. 1723/96)	2/4		A11
	Ferrites pour puces discrètes (2 dans le kit réf. 1723/95, 4 dans le kit réf. 1723/96)	2/4		A12
	Notice d'instructions pour ferrites (1 dans le kit réf. 1723/95, 2 dans le kit réf. 1723/96)	1/2		A13

Moniteur (B)	Moniteur modèle VMODO "Maître" (1 dans le kit réf. 1723/95, 2 dans le kit réf. 1723/96)	1/2		B1
	Etrier de fixation murale (1 dans le kit réf. 1723/95, 2 dans le kit réf. 1723/96)	1/2		B2
	Vis de fixation murale (ø2,9 x 32mm) (4 dans le kit réf. 1723/95, 8 dans le kit réf. 1723/96)	4/8		B3
	Cheilles de fixation murale (ø5mm) (4 dans le kit réf. 1723/95, 8 dans le kit réf. 1723/96)	4/8		B4
	Vis de fixation sur boîtier encastrable Mod.503 (M3,5 x 19 mm) (2 dans le kit réf. 1723/95, 4 dans le kit réf. 1723/96)	2/4		B5
	Levier de dépose de la façade du moniteur (1 dans le kit réf. 1723/95, 2 dans le kit réf. 1723/96)	1		B6
	Câble 6 voies pour le raccordement de dispositifs en option (1 dans le kit réf. 1723/95, 2 dans le kit réf. 1723/96)	1/2		B7
	Borniers extractibles pour raccorder le moniteur à l'installation (2 dans le kit réf. 1723/95, 4 dans le kit réf. 1723/96)	2/4		B8
	Câble 2 voies pour le raccordement d'une sonde de température en option (1 dans le kit réf. 1723/95, 2 dans le kit réf. 1723/96)	1/2		B9
Alimentation (C)	Alimentation du système	1		C1
	Inductance audio/vidéo	1		C2
(D)	Distributeur vidéo (uniquement dans le kit réf. 1723/96)	1		D

### 3 ACCESSOIRES

Description		N.bre maximum (en cas de configuration maximale de l'installation)	ID	
Serrure électrique (12 V~ Maxi 15 VA)	-	2 (une par plaque)		OP1
Bouton de commande de la serrure électrique pour piétons	-	2 (une par plaque)		OP2
Contacts du relais d'activation ouvre-porte d'accès véhicules (courant maxi commutable 1 A @ 30 V)	-	2 (une par plaque)		OP3
Capteur de porte ouverte	réf. 1033/701	2 (une par plaque)		OP4 (*)
Sonnerie radio (uniquement disponible sur le marché français)	code 43410	12 (trois par moniteur)		OP5 (**)
Sonnerie supplémentaire (max. 4 avec le kit réf. 1723/95, max. 8 avec le kit réf. 1723/96)	réf. 9854/43	4/8 (une par moniteur)		OP5A (**)
Moniteurs "Slave" supplémentaires modèle VMODO 7" mains-libres (max. 3 avec le kit réf. 1723/95, max. 6 avec le kit réf. 1723/96)	réf. 1723/97	3/6		OP6
Contact d'alarme magnétique	réf. 1033/701	2 (un par moniteur Maître)		OP7
Capteurs de présence (NF en l'absence de signal)	réf. 1033/012 réf. 1033/132	4 (deux par moniteur Maître)		OP7a (#)
Touche d'appel palier	-	2 (une par moniteur Maître)		OP8
Plaque secondaire mono-famille modèle MIKRA2.	réf. 1723/11	1		OP9
Plaque secondaire bi-famille modèle MIKRA2	réf. 1723/12	1		OP10
Module clavier	réf. 1723/46	2 (un par plaque)		OP11
Kit d'encastrement pour plaque	réf. 1723/50	2 (un par plaque)		OP12
Boîtier à relais pour 2 plaques	réf. 1723/51	1		OP13
Support de table pour moniteur 7" mains-libres (max. 4 avec le kit réf. 1723/95, (max. 8 avec le kit réf. 1723/96)	réf. 1723/52	4/8		OP14
Kit d'encastrement pour moniteur 7" mains-libres (max. 4 avec le kit réf. 1723/95, (max. 8 avec le kit réf. 1723/96)	réf. 1723/60	4/8		OP16

Interface 4 caméras de surveillance	réf. 1723/69	1		
Dispositif vidéo BALUN passif 1 voie	réf. 1092/300A	4 (un pour chaque caméra branchée sur l'interface 1723/69)		OP17
Kit de clés de proximité Mifare	réf. 1723/102	21 clés maxi dans l'installation.		OP18
Caméra compacte AHD JOUR & NUIT avec optique fixe 3,6mm (max. 4 avec le kit réf. 1723/95, (max. 8 avec le kit réf. 1723/96)	réf. 1092/250A	4/8 (une par moniteur)		OP19 (#)
Dispositif vidéo BALUN passif 1 voie	réf. 1092/300A	4/8 (un par caméra réf. 1092/250A)		
Sortie programmable pouvant être activée : - en appuyant sur le bouton Home Automation (fonction éclairage d'escalier par défaut), - en cas d'alarme, - par la fonction thermostat.	-	-		OP20 (**)
Relais temporisé 2000W	code 5454462	un par kit		
Relais 230V~	code 5454081	un par kit		
Emetteur 2 canaux modèle E2BPP	code 5454413	1 (uniquement dans le kit réf. 1723/95)		OP21 (*)
Emetteur 4 canaux modèle E4BPP	code 5454427	2 (uniquement dans le kit réf. 1723/96)		
Contact magnétique d'alarme (2 dans le kit réf. 1723/95, 4 dans le kit réf. 1723/96)	réf. 1033/701	2/4		
Sonde de température Yokis THERMPROBE (max. 4 avec le kit réf. 1723/95, (max. 8 avec le kit réf. 1723/96)	code 5454488	4/8 (une par moniteur)		OP22
Alimentation pour caméra réf. 1092/250A	réf. 1092/800	4 (une par caméra en cas d'utilisation de l'interface réf. 1723/69)		OP23
Module boucle magnétique pour malentendant	réf. 1723/48	2 (un par plaque)		OP24
Transformateur local pour 1723/97 (2 dans le kit réf. 1723/95, 6 dans le kit réf. 1723/96)	réf. 1723/22	2/6 (un pour chaque moniteur Esclave)		C4
Distributeur vidéo (uniquement dans le kit réf. 1723/96)	réf. 1723/55	1		D

(\*) Ces deux options s'excluent mutuellement.

(\*\*) Pour plus d'informations, voir le paragraphe 7.5 FONCTIONS ET CONFIGURATIONS DES RELAIS

(#) Ces deux options s'excluent mutuellement.

## 4 PIECES DETACHEES

Description	ID	Description	ID
Alimentation système Réf. 1723/20	C1	Vidéophone « Maître » 7" mains-libres Mod. VMODO	B1
Inductance audio/vidéo Réf. 1723/112	C2	Clavier Mod. MIKRA2 avec 1 touche d'appel (uniquement dans le kit réf. 1723/95)	A1
Distributeur vidéo Réf. 1723/55	D	Clavier Mod. MIKRA2 avec 2 touches d'appel (uniquement dans le kit réf. 1723/96)	A2

## 5 SYNOPTIQUES DE CONNEXION

### 5.1 INSTALLATION MONO-FAMILLE

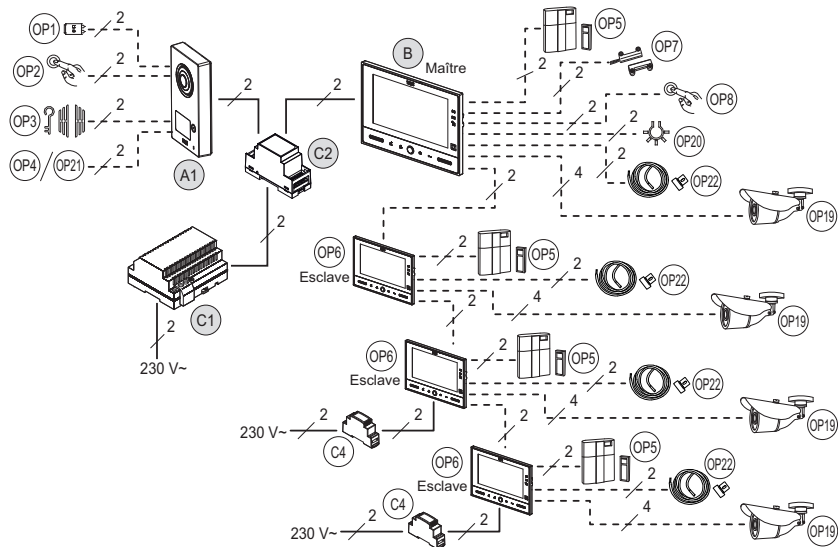

#### 5.1.1 Distances maximales entre les dispositifs

Tronçon	Type de câble					
	SYT1-3P-AWG20 (Ø 0,8 mm)	Paire torsadée téléphonique Ø 0,6 mm, sans gaine	CAT5	1,5 mm <sup>2</sup> simple	2Voice	PTT278
A1 – C2	150 m	150 m	100 m	75 m	200 m	100 m
C1 – C2	0,5 m	0,5 m	0,5 m	0,5 m	0,5 m	0,5 m
C2 – le moniteur le plus éloigné (OP6)	50 m	50 m	50 m	20 m	50 m	50 m
A – OP1	10 m	10 m	10 m	20 m	20 m	10 m
A – OP2	50 m	50 m	30 m	50 m	50 m	50 m
A – OP3	10 m	10 m	10 m	20 m	20 m	10 m
A – OP4	25 m	25 m	25 m	25 m	25 m	25 m
A – OP21	10 m	10 m	10 m	10 m	10 m	10 m
B – OP5	30 m	30 m	30 m	30 m	30 m	30 m
B – OP7	30 m	30 m	30 m	30 m	30 m	30 m
B – OP8	30 m	30 m	30 m	30 m	30 m	30 m
B – OP19	-	-	50 m	-	-	-
B – OP20	30 m	30 m	30 m	30 m	30 m	30 m
OP6 – C4	20 m	10 m	10 m	30 m	20 m	20 m
OP6 – OP5	30 m	30 m	30 m	30 m	30 m	30 m

Les câbles utilisés doivent satisfaire la norme IEC 60332-1-2 si la section mesure au moins 0,5 mm<sup>2</sup>, ou la norme IEC 60332-2-2 si la section mesure moins de 0,5 mm<sup>2</sup>.

## 5.2 INSTALLATION BI-FAMILLE

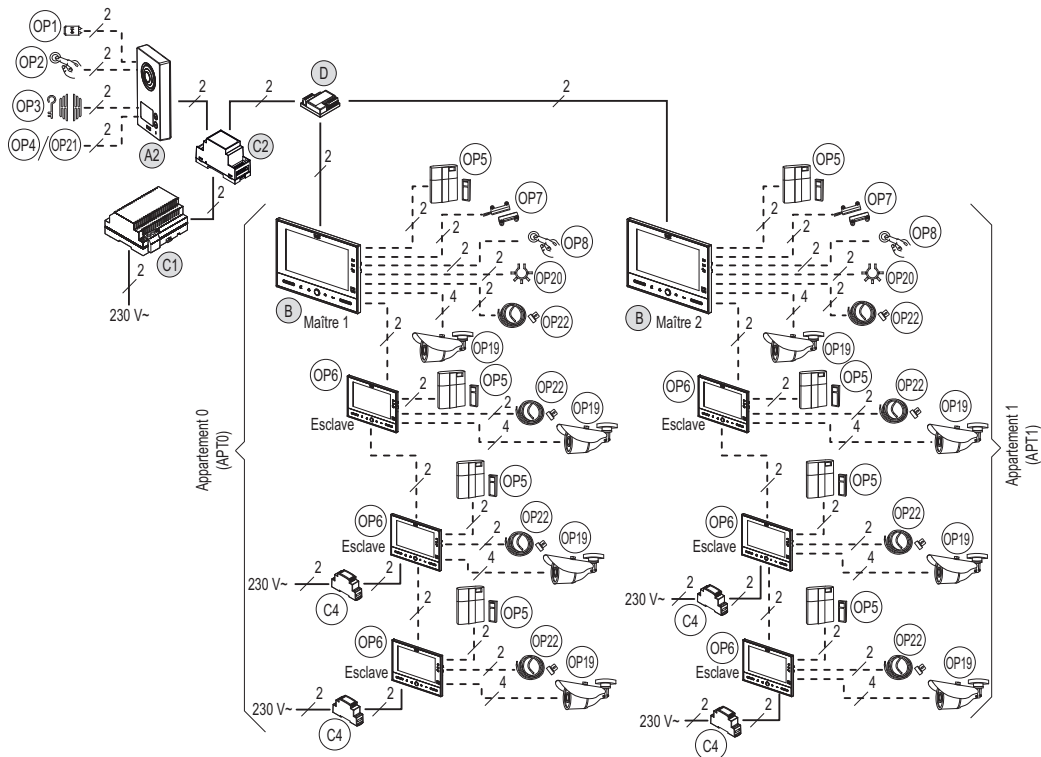

### 5.2.1 Distances maximales entre les dispositifs

Tronçon	Type de câble					
	SYT1-3P-AWG20 (Ø 0,8 mm)	Paire torsadée téléphonique Ø 0,6 mm, sans gaine	CAT5	1,5 mm <sup>2</sup> simple	2Voice	PTT278
A2 – C2	150 m	150 m	100 m	75 m	200 m	100 m
C1 – C2	0,5 m	0,5 m	0,5 m	0,5 m	0,5 m	0,5 m
C2 – D	5 m	5 m	5 m	5 m	5 m	5 m
C2 – le moniteur le plus éloigné (OP6)	50 m	50 m	50 m	20 m	50 m	50 m
A – OP1	10 m	10 m	10 m	20 m	20 m	10 m
A – OP2	50 m	50 m	30 m	50 m	50 m	50 m
A – OP3	10 m	10 m	10 m	20 m	20 m	10 m
A – OP4	25 m	25 m	25 m	25 m	25 m	25 m
A – OP21	10 m	10 m	10 m	10 m	10 m	10 m
B – OP5	30 m	30 m	30 m	30 m	30 m	30 m
B – OP7	30 m	30 m	30 m	30 m	30 m	30 m
B – OP8	30 m	30 m	30 m	30 m	30 m	30 m
B – OP19	-	-	50 m	-	-	-
B – OP20	30 m	30 m	30 m	30 m	30 m	30 m
OP6 – C4	20 m	10 m	10 m	30 m	20 m	20 m
OP6 – OP5	30 m	30 m	30 m	30 m	30 m	30 m

Les câbles utilisés doivent satisfaire la norme IEC 60332-1-2 si la section mesure au moins 0,5 mm<sup>2</sup>, ou la norme IEC 60332-2-2 si la section mesure moins de 0,5 mm<sup>2</sup>.

## 6 AVERTISSEMENTS POUR L'INSTALLATEUR

Lire attentivement les instructions contenues dans le présent document, car elles fournissent d'importantes indications pour la sécurité d'installation, d'utilisation et d'entretien.

- Les dispositifs inclus dans le kit doivent être exclusivement destinés à l'utilisation pour laquelle ils ont été expressément conçus. Toute autre utilisation doit être considérée comme étant inappropriée. Le Constructeur ne saurait être tenu pour responsable des éventuels dommages résultant d'utilisations inappropriées ou illégitimes.
- Chaque élément a été étudié conformément aux normes en vigueur.
- L'exécution de l'installation doit être conforme aux normes en vigueur. Tous les appareils constituant l'installation doivent être exclusivement destinés à l'utilisation pour laquelle ils ont été conçus.
- Après avoir sorti les différents composants de leur emballage, s'assurer de leur état intact.
- Les éléments d'emballage (sacs en plastique, polystyrène expansé, etc.) doivent être mis hors de la portée des enfants, car ils représentent des sources potentielles de danger.
- Prévoir, en amont des appareils, un interrupteur approprié de sectionnement et protection, avec une distance d'ouverture des contacts d'au moins 3 mm.
- Avant de brancher les dispositifs d'alimentation, vérifier que les paramètres indiqués sur la plaque signalétique correspondent bien à ceux de l'alimentation secteur.
- Ne jamais obstruer les orifices ou les fentes de ventilation ou de dispersion de la chaleur.
- Avant d'exécuter toute opération de nettoyage ou d'entretien, mettre les dispositifs hors tension, en désactivant l'interrupteur général de l'installation.
- Ne pas utiliser de produits de nettoyage en spray.
- En cas de panne et/ou de dysfonctionnement des produits inclus dans le kit, couper l'alimentation électrique à l'aide de l'interrupteur général, sans endommager ni manipuler l'appareil.
- Pour toute réparation, contacter le service après-vente agréé par le Constructeur.
- Assurer une bonne ventilation.
- Ne pas utiliser de rallonges pour le câble d'alimentation.
- En cas d'infiltration de liquides ou en présence de corps étrangers dans l'appareil, s'adresser à un personnel qualifié pour les opérations de contrôle ou de réparation.
- Pour les réparations, utiliser exclusivement des pièces de rechange d'origine.
- L'installateur devra vérifier que les informations à l'attention de l'utilisateur sont bien présentes sur les appareils dérivés.
- Le non-respect des prescriptions précédentes peut compromettre la sécurité de l'installation.
- Le présent document doit toujours accompagner l'appareil.
- Le pictogramme de la foudre avec une flèche à l'intérieur d'un triangle équilatéral signale la présence de tensions dangereuses.



- Ne pas ouvrir les dispositifs, à moins que cela ne soit expressément prescrit dans la présente notice.
- Le pictogramme du point d'exclamation à l'intérieur d'un triangle équilatéral désigne des composants critiques pour la sécurité; n'utiliser que les composants fournis par le Constructeur.



# 7 INSTALLATION DU MONITEUR

## 7.1 DESCRIPTION DES COMPOSANTS

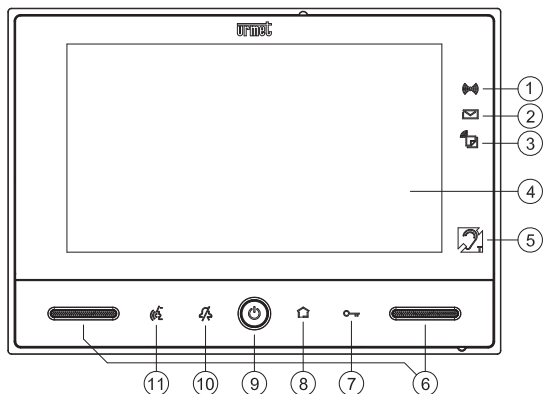

### Façade:

1. Icône Alarme
2. Icône de présence de courrier dans la boîte aux lettres (fonction LETTERBOX)
3. Icône d'indication de répondeur actif (lumière verte fixe) / présence de messages audio POST-IT (lumière rouge clignotante) / fonction renvoi d'appel active (lumière jaune fixe) (uniquement sur le vidéophone Maître réf. 1723/98).
4. Afficheur 7"
5. Icône indiquant que le moniteur est doté de répétition de phonie pour les malentendants (boucle magnétique)
6. Haut-parleurs
7. Touche ouvre-porte
8. Icône de confirmation de réception commande Yokis
9. Bouton marche/arrêt (ON/OFF)
10. Touche "MUTE"
11. Touche d'activation phonie

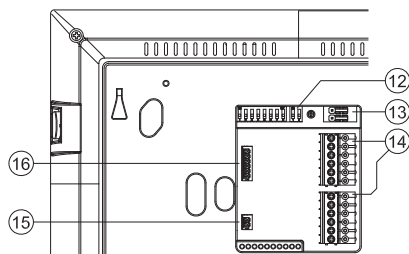

### Partie arrière :

12. Commutateurs de configuration
13. Cavaliers
14. Borniers extractibles à 6 voies
15. Connecteur 2 voies pour thermostat externe
16. Connecteur 6 voies pour le raccordement de la caméra externe / relais 2 (OP20)



## 7.2 MODALITES D'INSTALLATION

- Fixer l'étrier à la paroi en utilisant un boîtier 503 et les vis livrées de série, ou bien un boîtier Ø 60 mm avec des vis appropriées.
- Programmer les commutateurs et brancher les conducteurs de l'installation sur les borniers.
- Accrocher le moniteur à l'étrier, au niveau des quatre crochets latéraux.
- Retirer le film de protection de l'afficheur.

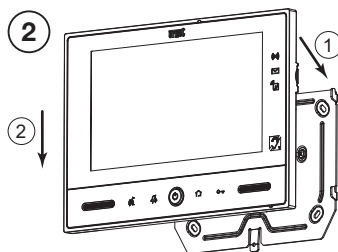
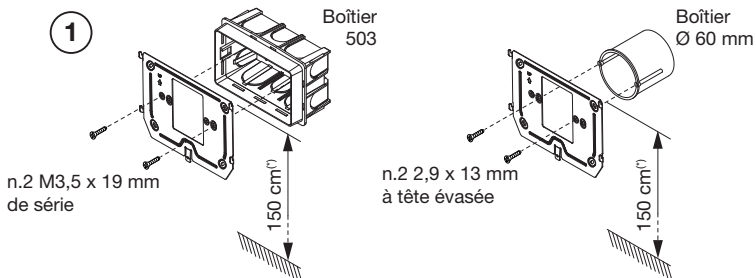

(\*) Pour garantir le respect de la Directive de référence pour les personnes handicapées (par exemple, en France, voir la Loi 2005-102 du 11/02/2005, le Décret 2006-555 du 17/05/2006 et ses amendements ultérieurs des 1/08/2006, 26/02/2007 et 21/03/2007), l'écran du moniteur devra être mis en place à une hauteur comprise entre 90 et 130 cm.

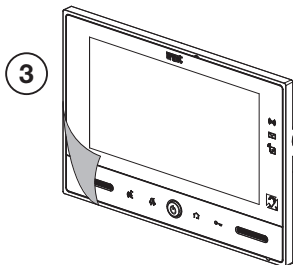

 Retirer le film de protection de l'afficheur du vidéophone.

## 7.3 DESCRIPTION DES BORNIERES

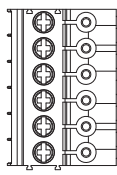
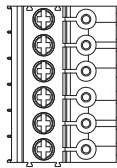
	Bornier	Nom du bornier	Description
1		LI	Entrée Bus (LINE IN)
		LI	
		LO	Sortie Bus (LINE IN)
		LO	
		LP	24Vca alimentation locale
		LP	
2		FC	Appel palier
		FC	
		0	Sonnerie supplémentaire (sortie relais 1 – OP5 / OP5A)
		C	
		AL	Entrée capteur d'alarme
		AL	

## 7.4 DESCRIPTION DU CONNECTEUR POUR LA CAMERA EXTERNE / RELAIS 2 (OP20)

La caméra externe réf. 1092/250A peut être branchée sur le moniteur Maître à l'aide du câble (B7), livré de série.

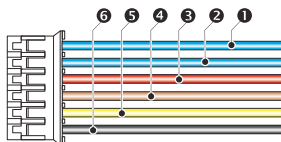

N. fil	Couleur fil	Description	Nom de la broche sur le connecteur
1	Bleu	Eclairage d'escalier (sortie relais 2 – OP20)	RELAY SPARE
2	Bleu	Eclairage d'escalier (sortie relais 2 – OP20)	RELAY SPARE
3	Rouge	Positif d'alimentation caméra	CCTV POWER+
4	Marron	Négatif du signal sortant du système vidéo « balun »	CCTV VIDEO-
5	Jaune	Positif du signal sortant du système vidéo « balun »	CCTV VIDEO+
6	Noir	Négatif d'alimentation caméra	CCTV POWER-

## 7.5 FONCTIONS ET CONFIGURATIONS DES RELAIS

Le moniteur est équipé de deux relais programmables, comme indiqué dans le tableau suivant :

Relais	Fonction possible	Par défaut	Référence
1	Sonnerie supplémentaire	✓	OP5 / OP5A
	Bouton Domotique 1		
	Alarme sirène		
2	Bouton Domotique 2	✓	OP20
	Alarme sirène		
	Sortie thermostat		

## 7.6 CONFIGURATION DES CAVALIERS (JP1 et JP2)

Le moniteur comprend deux cavaliers :

- JP1 : permet d'activer la terminaison de ligne. Il est nécessaire d'activer la terminaison de ligne sur le dernier moniteur raccordé à la fin d'une ligne qui ne donne pas naissance à un nouveau tronçon depuis les bornes LINE OUT.

	JP1
Terminaison activée (par défaut)	
Terminaison non activée	

- JP2 : permet d'alimenter le moniteur depuis la ligne bus ou via un transformateur local réf. 1723/22.



	JP2
Alimentation depuis la ligne Bus (par défaut)	
Alimentation depuis le transformateur local	

## 7.7 CONFIGURATION DES COMMUTATEURS

Le moniteur comprend 8 commutateurs, situés à l'arrière du dispositif.





- 🔧 Les commutateurs 5, 7 et 8 ne sont pas utilisés.

### 7.7.1 Association bouton d'appel/ moniteur



	Position du commutateur 1		Position du commutateur 1
Moniteur associé au bouton d'appel 0 (en haut)		Moniteur associé au bouton d'appel 1 (en bas)	

### 7.7.2 Code du moniteur

En cas d'installation de moniteurs Esclaves, il est nécessaire de configurer le code correspondant sur chaque poste interne à l'aide des commutateurs 2 et 3.



Typologie de moniteur	Position des commutateurs 2 et 3	Typologie de moniteur	Position des commutateurs 2 et 3
Moniteur Maître		Moniteur Esclave n. 1	
Moniteur Esclave n. 2		Moniteur Esclave n. 3	

### 7.7.3 Typologie d'installation

	Position du commutateur 4		Position du commutateur 4
Installation mono-famille		Installation bi-famille	



### 7.7.4 Activation de la phonie en appuyant sur la touche (mode "Push to talk")

Si la communication entre le clavier et le vidéophone est perturbée ou absente, s'assurer d'avoir retiré le film de protection transparent qui recouvre l'afficheur du vidéophone. Si le film de protection a bien été retiré et que le son demeure perturbé, il est possible d'activer individuellement les deux canaux de phonie (vers l'intérieur et vers l'extérieur).

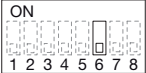
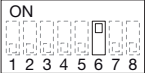
Après avoir reçu un appel, appuyer brièvement sur  pour activer la phonie depuis la plaque ; ensuite, si la touche  est maintenue enfoncée, le canal audio vers l'extérieur sera activé et la communication avec l'appelant sera établie. Pour écouter, il est nécessaire de relâcher la touche .

	Position du commutateur 6		Position du commutateur 6
Fonction désactivée		Fonction activée	

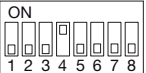
### 7.7.5 Paramètres d'usine :

<b>Kit mono-famille réf. 1723/95:</b>	Moniteur	
<b>Kit bi-famille réf. 1723/96:</b>	Moniteur 1	
	Moniteur 2	

## 8 INSTALLATION DE L'ALIMENTATION SYSTEME ET DE L'INDUCTANCE AUDIO/VIDÉO

L'alimentation doit être installée à l'intérieur d'un tableau ou d'une armoire électrique.

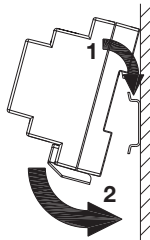

Installation sur barre DIN (6 modules de 18 mm)

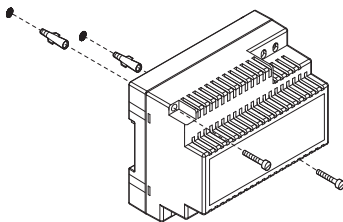

Installation murale en saillie

Le module d'inductance peut être fixé à la paroi à l'aide de l'étrier livré de série ou bien sur barre DIN (2 modules de 18 mm).

Le module d'inductance doit être installé dans la même armoire électrique que celle de l'alimentation.

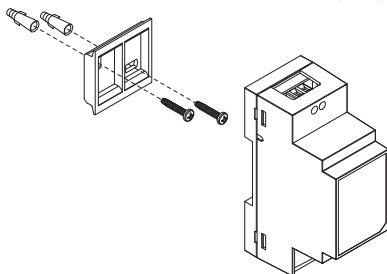

### 8.1.1 Description des bornes

#### Alimentation de système réf. 1723/20

- |   |               |  |
|---|---------------|--|
| ⊗ | 110-230V~ / N | } Entrée tension d'alimentation secteur 110-230 V~ |
| ⊗ | +             |  |
| ⊗ | -             | } Sortie tension d'alimentation                    |

#### Inductance audio/vidéo réf. 1723/112

- |   |   |                                 |
|---|---|---------------------------------|
| ⊗ | + | } Entrée tension d'alimentation |
| ⊗ | - |                                 |
| ⊗ | ] | LINE1 Ligne BUS 1               |
| ⊗ |   | LINE2 Ligne BUS 2               |

## 9 INSTALLATION DE LA PLAQUE DE RUE

### 9.1 DESCRIPTION DES COMPOSANTS

Plaque modèle MIKRA2 avec 1 touche d'appel  
(uniquement dans le kit mono-famille réf. 1723/95)

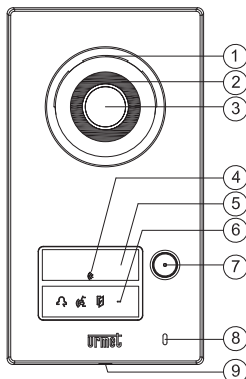

Plaque modèle MIKRA2 avec 2 touches d'appel  
(uniquement dans le kit bi-famille réf. 1723/96)

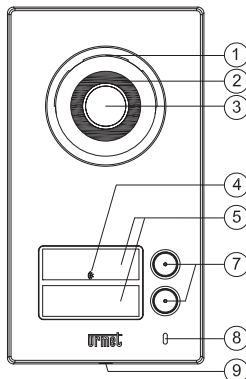

#### Façade:

1. Haut-parleur
2. Diode d'éclairage caméra
3. Caméra
4. Lecteur de badge
5. Etiquette(s) de nom
6. Diodes de signalisation pour la fonction signalisation
7. Bouton(s) d'appel
8. Microphone
9. Vis de fermeture façade

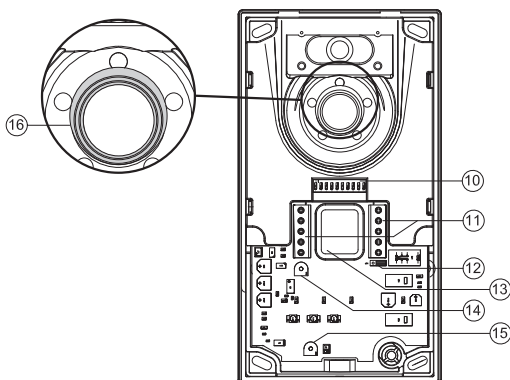

#### Partie intérieure :

10. Commutateurs de configuration
11. Borniers
12. **Ne pas modifier la position de ce cavalier !**
13. Orifice pour le passage des câbles
14. Sélecteur de réglage du niveau phonique du haut-parleur
15. **Ne pas tourner ce sélecteur !**
16. Joint antireflet

## 9.2 MODALITES D'INSTALLATION

- Installer la plaque à la hauteur indiquée.
- Brancher les fils sur les borniers.
- Installer les étiquettes des noms sur la façade.
- Effectuer les programmations.
- Si nécessaire, régler le niveau phonique du haut-parleur.
- Refermer la plaque à l'aide de son couvercle métallique.
- Retirer les films de protection

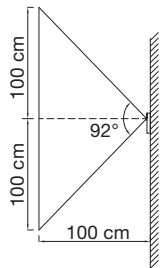

Champ de vision vertical

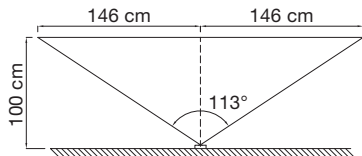

Champ de vision horizontal

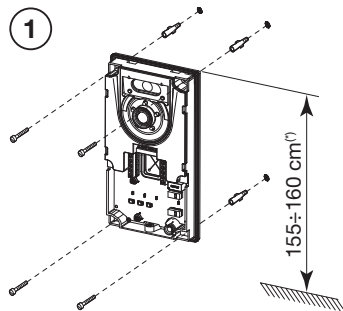

(\*) Respecter une hauteur de pose de 1,30 m pour se conformer à la Directive de référence pour les personnes handicapées (par exemple, en France, voir la Loi 2005-102 du 11/02/2005, le Décret 2006-555 du 17/05/2006 et ses amendements ultérieurs des 1/08/2006, 26/02/2007 et 21/03/2007).

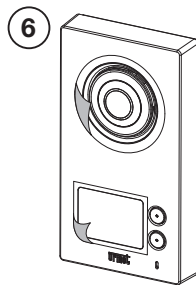
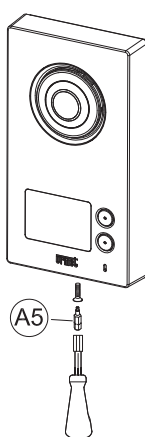
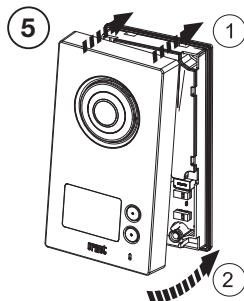
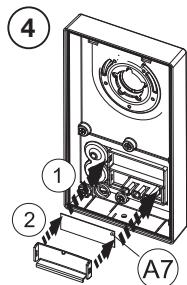
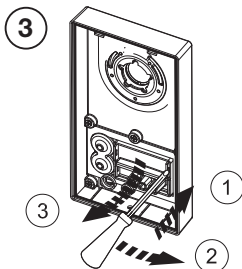
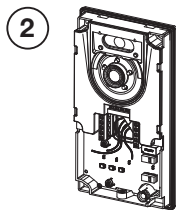

## 9.3 DESCRIPTION DES BORNES

### Bornier gauche

- SE- Négatif d'actionnement de la serrure électrique à décharge capacitive
- SE+ Positif d'actionnement de la serrure électrique à décharge capacitive
- } PA Entrée pour bouton serrure électrique pour piétons
- SP Entrée pour capteur réservé à la fonction ETAT PORTE ou LETTERBOX (BOITE AUX LETTRES)

### Bornier droit



- SP Entrée pour capteur réservé à la fonction ETAT PORTE ou LETTERBOX (BOITE AUX LETTRES)
- } LINE Ligne Bus
- } N.O. Activation contact sec ouvre-porte (OP3)

## 9.4 CONFIGURATION DES COMMULATEURS



La plaque comprend 10 commutateurs, situés à l'intérieur du dispositif.

🔧 **Les commutateurs 6, 9 et 10 ne doivent pas être modifiés.**



### 9.4.1 Sélection de la fonction ETAT PORTE ou LETTERBOX (signal de présence de courrier dans la boîte aux lettres)

	Position du commutateur 1		Position du commutateur 1
Fonction ETAT PORTE activée		Fonction LETTERBOX activée	



### 9.4.2 N. d'identification de la plaque

	Position du commutateur 2		Position du commutateur 2
Plaque 1		Plaque 2	



### 9.4.3 Allumage des diodes de la caméra en cas d'appel

	Position du commutateur 3		Position du commutateur 3
Fonction habilitée		Fonction exclue	

### 9.4.4 Habilitation à l'appel de l'appartement 0 à l'aide des deux boutons de la plaque (fonction uniquement disponible avec le kit bi-famille réf. 1723/96)

	Position du commutateur 4		Position du commutateur 4
Fonction exclue		Fonction habilitée	



### 9.4.5 Sélection du type d'activation de la serrure électrique pour piétons et d'accès véhicules, si du type à décharge capacitive ou par relais à contact sec

	Position du commutateur 5		Position du commutateur 5
Activation de la serrure électrique pour piétons par charge capacitive à impulsion et courant de maintien (bornes SE+ et SE-); activation de l'accès véhicules par relais à contact sec (bornes N.O).		Activation de la serrure électrique pour piétons par relais à contact sec (bornes N.O); activation de l'accès véhicules par charge capacitive à impulsion et courant de maintien (bornes SE+ et SE-).	

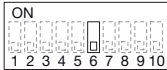
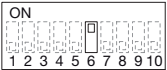

#### 9.4.6 Configuration du type de plaque

	Position du commutateur 6		Position du commutateur 6
Plaque mono-famille		Plaque bi-famille	

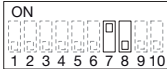
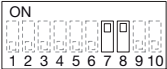
#### 9.4.7 Réglage de la durée d'activation de la serrure électrique à décharge capacitive

	Position du commutateur 7-8		Position du commutateur 7-8
0 s (impulsion de 300ms)		3 s	
6 s		9 s	

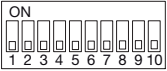
#### 9.4.8 Paramètres d'usine

Kit mono-famille réf. 1723/95:	Plaque 1	
Kit bi-famille réf. 1723/96:	Plaque 2	

### 9.5 REGLAGE DU NIVEAU PHONIQUE DU HAUT-PARLEUR

Les niveaux phoniques sont réglés en usine et ne doivent pas être modifiés dans la plupart des installations. Si une modification est nécessaire, agir sur le réglage du volume du haut-parleur à l'aide d'un tournevis (voir point 14 du paragraphe 9 - INSTALLATION DE LA PLAQUE).

## 10 CARACTERISTIQUES TECHNIQUES

#### Alimentation système

Alimentation CAT III 4000 V

Alimentation : ..... 110-230 V~ 50-60 Hz  
 Puissance : ..... 75 W (maximum)  
 Sortie secondaire : ..... 50 V --- 1 A  
 Puissance absorbée après 1 heure de fonctionnement : ..... Maximum 5 Wh (18 kJ)  
 Dimensions (LxHxP) : ..... 108 (6 modules DIN) x 90 x 61 mm

#### Inductance audio/vidéo

Dimensions (LxHxP) : ..... 36 (2 modules DIN) x 95 x 57 mm

#### Moniteur

Tension d'alimentation : ..... par BUS 37÷48 V ---  
 Par transformateur local 24 V~ (+-10%)  
 Absorption : maximum ..... 280 mA @ 48 V ---  
 au repos (configuration de base) ..... 25 mA @ 48 V ---  
 Puissance absorbée en cours de fonctionnement : ..... maximum 16 W  
 Afficheur à cristaux liquides : ..... 7", IPS rétro-éclairé  
 Résolution ..... 1024H x 600V pixels  
 Angle de vue : ..... >±80°  
 Délai d'allumage : ..... 2 s maximum  
 Capsule émettrice : ..... microphone à électret  
 Capsule réceptrice : ..... haut-parleur 45 Ω  
 Support pour mémoire externe : ..... microSD standard (capacité conseillée : 2 GO)  
 Portée radio :  
 • à l'intérieur d'une habitation de 100m<sup>2</sup> avec traversée perpendiculaire d'un mur porteur ou d'une dalle ;  
 • 250m à l'air libre  
 ↗ Dans les deux cas, réduction de la portée en présence d'éléments métalliques, de traversée de murs ou de cloisons.



Transmission radio : la diode de l'émetteur ne s'allume que si la transmission a abouti. En cas de portée insuffisante, l'ajout d'un récepteur intermédiaire permet de résoudre le problème. Se reporter à la notice d'instructions des émetteurs Yokis.

Bande de fréquence:

WiFi: ..... 2400 ÷ 2483,5 MHz  
 Yokis: ..... 2400 ÷ 2480 MHz  
 Mifare: ..... 13,56 MHz

Puissance de sortie (Max):

WiFi: ..... 20 dBm  
 Yokis: ..... 10 dBm  
 Mifare: ..... -13 dBµA/m @ 10m

Sortie relais 1 (OP5 / OP5A) ..... 100 mA @ 24 V ---

Sortie relais 2 (OP20 - RELAY SPARE) ..... 25 mA @ 24 V ---

Température de fonctionnement : ..... -5 ÷ +45 °C

Humidité maximum : ..... 95% HR

Dimensions (LxHxP) : ..... 202 x 142 x 22 mm

### Plaque de rue

Tension d'alimentation : ..... 36÷48 V ---

Absorption : maximum ..... 130 mA @ 48 V ---  
 au repos ..... 20 mA @ 48 V ---

Puissance absorbée en cours de fonctionnement : ..... maximum 6,5 W

Dimensions (LxHxP) : ..... 100 x 180 x 28 mm

Dimensions étiquette de nom : ..... 48,5 x 15,5 mm

Eclairage étiquettes et touches : ..... Diodes blanches

Degré de protection des boîtiers : ..... IP45

Degré de protection contre les chocs mécaniques : ..... IK07

Température de fonctionnement : ..... -10 ÷ +50 °C

Humidité maximum : ..... 95% HR





Courant maximum contact sec N.O. (OP3) : ..... 1 A @ 30 V ---

Capsule émettrice : ..... microphone à électret

Capsule réceptrice : ..... haut-parleur 16 Ω étanche

⚡ Les câbles utilisés doivent satisfaire la norme IEC 60332-1-2 si la section mesure au moins 0,5 mm<sup>2</sup>, ou la norme IEC 60332-2-2 si la section mesure moins de 0,5 mm<sup>2</sup>.

## 11 LÉGENDES SYMBOLES

Symbole	Explication
---	Tension d'alimentation continue
~	Tension d'alimentation alternée
<b>note 2</b>	Marque commerciale du système vidéo
	Alimentation à double isolement
	DANGER – Présence de tensions dangereuses
	DANGER – Présence de composants critiques pour la sécurité
 	Se reporter au manuel d'installation du dispositif

## 12 DECLARATION UE DE CONFORMITE SIMPLIFIEE

Le soussigné, URMET S.p.A., déclare que les équipements radioélectriques du type **KIT VIDEOPHONE 2 FILS MONO/BI-FAMILLE AVEC RENVOI D'APPEL** (Réf. 1723/95 et 1723/96) sont conformes à la directive 2014/53/UE.

Le texte complet de la déclaration UE de conformité

est disponible à l'adresse internet suivante: [www.urmet.com](http://www.urmet.com)

**0 825 890 830**

Service 0,15 € / min  
+ prix appel

**ÍNDICE**

1	DESCRIPCIÓN GENERAL .....	63
2	COMPOSICIÓN DEL KIT .....	65
3	DISPOSITIVOS ACCESORIOS .....	67
4	PIEZAS DE REPUESTO .....	69
5	DIAGRAMA DE BLOQUES DE CONEXIÓN .....	69
5.1	SISTEMA MONOFAMILIAR .....	69
5.1.1	Distancias máximas entre los dispositivos .....	69
5.2	SISTEMA BIFAMILIAR .....	70
5.2.1	Distancias máximas entre los dispositivos .....	70
6	ADVERTENCIAS PARA EL INSTALADOR .....	71
7	INSTALACIÓN DEL VIDEOINTERFONO .....	72
7.1	DESCRIPCIÓN DE LOS COMPONENTES .....	72
7.2	MODO DE INSTALACIÓN .....	73
7.3	DESCRIPCIÓN DE LOS TABLEROS DE BORNES .....	73
7.4	DESCRIPCIÓN DEL CONECTOR PARA LA CÁMARA EXTERNA / RELÉ 2 (OP20).....	74
7.5	FUNCIONES Y CONFIGURACIÓN DE LOS RELÉS .....	74
7.6	CONFIGURACIÓN DE LOS PUENTES (JP1 y JP2) .....	74
7.7	CONFIGURACIÓN DE LOS INTERRUPTORES DIP .....	74
7.7.1	Asociación de un pulsador de llamada al videointerfono .....	75
7.7.2	Código del videointerfono .....	75
7.7.3	Tipo de sistema .....	75
7.7.4	Activación de la fonía accionando el pulsador (modo "Push to talk") .....	75
7.7.5	Configuraciones de fábrica: .....	75
8	INSTALACIÓN DEL ALIMENTADOR DEL SISTEMA Y DE LA INDUCTANCIA AUDIO VÍDEO .....	76
8.1.1	Descripción de los bornes .....	76
9	INSTALACIÓN DEL TECLADO .....	77
9.1	DESCRIPCIÓN DE LOS COMPONENTES .....	77
9.2	MODO DE INSTALACIÓN .....	78
9.3	DESCRIPCIÓN DE LOS BORNES .....	79
9.4	CONFIGURACIÓN DE LOS INTERRUPTORES DIP .....	79
9.4.1	Selección de la función ESTADO PUERTA o LETTERBOX (indicación de presencia de correo en el buzón) .....	79
9.4.2	Nº de identificación del teclado .....	79
9.4.3	Encendido de los leds de la cámara en fase de llamada .....	79
9.4.4	Habilitación para la llamada del apartamento 0 con los dos pulsadores presentes en el teclado .....	79
9.4.5	Selección del tipo de activación de la cerradura eléctrica para peatones y del pasaje para vehículos: con descarga capacitiva o de relé con contactos limpios .....	79
9.4.6	Configuración del tipo de teclado .....	80
9.4.7	Regulación del tiempo de activación de la cerradura eléctrica con descarga capacitiva .....	80
9.4.8	Configuraciones de fábrica .....	80
9.5	REGULACIÓN DEL NIVEL FÓNICO DEL ALTAVOZ .....	80
10	CARACTERÍSTICAS TÉCNICAS .....	80
11	LEYENDA DE LOS SÍMBOLOS .....	81
12	DECLARACIÓN UE DE CONFORMIDAD SIMPLIFICADA .....	81
13	ESQUEMAS DE CONEXIÓN .....	122
13.1	CONEXIÓN DEL KIT MONOFAMILIAR REF. 1723/95 CON 3 VIDEOINTERFONOS EN PARALELO .....	122
13.2	CONEXIÓN DEL KIT BIFAMILIAR REF. 1723/96 CON 3 VIDEOINTERFONOS EN PARALELO A CADA USUARIO. ....	124
13.3	CONEXIÓN DEL TIMBRE ADICIONAL AL VIDEOINTERFONO .....	126
13.4	LEYENDAS DE LOS DIAGRAMAS .....	127
13.5	NOTAS REFERIDAS A LOS ESQUEMAS .....	129

# 1 DESCRIPCIÓN GENERAL

Los kits videointerfónicos Mod. NOTE2 se caracterizan por la facilidad de instalación gracias al uso de sólo 2 cables no polarizados para la interconexión entre los diversos dispositivos.

Su carácter modular permite complementar numerosas funciones adicionales, además de las básicas del sistema videointerfónico, ofreciendo soluciones para todas las exigencias.

Las características del sistema videointerfónico son las siguientes:

## Sistema

- Kit monofamiliar ref. 1723/95:
  - Permite utilizar 2 videointerfonos sin ninguna alimentación adicional;
  - Puede gestionar hasta 4 videointerfonos (1 “Master” y 3 “Slaves”) llamados en paralelo, con conexión entrar-salir;
- Kit bifamiliar ref. 1723/96:
  - Permite el uso de 2 videointerfonos sin ninguna fuente de alimentación suplementaria, 1 por apartamento;
  - Puede gestionar hasta 8 videointerfonos (2 “Masters” y 6 “Slaves”) llamados en paralelo, con distribuidor vídeo de columna y conexión en entrar-salir en el piso;
- Conexión de todos los dispositivos sólo con 2 cables no polarizados;
- Conexión del alimentador en cualquier punto del sistema entre teclado y videointerfono;
- Posibilidad de gestionar hasta 2 puestos de llamada en conmutación automática;
- Posibilidad de extender la longitud de los bus mediante dispositivo adicional;
- Configuración de los dispositivos mediante puentes e interruptores dip;
- Conexiones al sistema mediante tableros de bornes extraíbles.

## Teclado

- Teclado antivandalismo Mod. MIKRA2 con frente de zamak resistente a los agentes atmosféricos, con uno o dos pulsadores;
- Instalación de apoyo de pared (estándar), posibilidad de instalación empotrada con el kit específico;
- Cámara del teclado de colores, con amplio ángulo de enfoque (wide-angle) e iluminación de la persona con leds;
- Lector de llaves de proximidad MIFARE;
- Tarjetero para nombres iluminado en la cara posterior de color blanco;
- Activación de la cerradura eléctrica para peatones con descarga capacitiva de impulso y corriente de mantenimiento, con tiempo de activación programable;
- Preparación para la conexión de un pulsador de vestíbulo para la activación de la cerradura eléctrica para peatones en local;
- Preparación para la conexión del sensor específico para la función ESTADO PUERTA o LETTERBOX (buzón);
- Activación de la cerradura eléctrica para peatones acercando al teclado las llaves de proximidad entregadas;
- Manejo de la cerradura eléctrica del pasaje para vehículos con relé con contactos limpios;
- Confirmación de envío de la llamada con indicación acústica y el apagado de los leds de iluminación de la cara posterior del tarjetero;
- Encendido de los leds de la cámara en fase de llamada con la posibilidad de exclusión;
- Posibilidad de ajustar el nivel fónico del altavoz del teclado;
- Indicación visual y acústica del estado del sistema (DDA), función disponible sólo con teclado monofamiliar;
- Micrófono incorporado resistente al agua.

## Aparato interior

- Aparatos interiores videointerfónicos manos libres Mod. VMODO con pantalla de colores LCD de 7” y pantalla táctil capacitiva;
- Instalación de apoyo de pared (estándar), posibilidad de instalación empotrada con el kit específico;
- Interfaz del usuario disponible en varios idiomas (IT, EN, FR, ES, DE, CS, NL, NO, PL, PT, SK, VLS);
- Modo de conversación en manos libres o mediante el accionamiento del pulsador (modo “Push to talk”):
  - Manos libres: accionando el pulsador de fonía se activa la conversación y, accionándolo una segunda vez, la misma se desactiva;
  - Push to talk: cuando el pulsador de fonía se mantiene accionado se puede hablar desde el aparato interior, mientras que cuando se suelta el pulsador se puede escuchar;

- Melodías de llamada: 5 estándar más 1 a personalizar por el usuario;
- Posibilidad de asignar distintas melodías según la procedencia de la llamada (de teclado, intercomunicante, llamada al piso, indicación de alarma);
- Equipado con:
  - Dispositivo de repetición de la fonía para hipoacúsicos (ILA);
  - N° 2 salidas configurables de relé con contactos limpios para la activación de mandos auxiliares;
  - Iluminación en la cara posterior de los pulsadores táctiles con led rojo o verde
- Posibilidad de conectar directamente al videointerfono:
  - Una cámara TVCC local ref. 1092/250A;
  - Un pulsador de llamada al piso (Sólo en "Master");
  - Un sensor de temperatura Yokis THERMPROBE (Cod. 5454488);
  - Un contacto de alarma (Sólo en "Master");
- Posibilidad de conectar a cada videointerfono, para la repetición de la llamada, un timbre adicional o un repetidor de llamada analógico (sólo para el mercado francés).
- Posibilidad de cambiar la relación de visualización de la imagen de 4:3 a 16:9;
- Posibilidad de ajuste audio (volumen del altavoz) y vídeo (brillo, contraste y color);
- Ajuste del volumen de llamada con la posibilidad de excluirlo temporalmente (función "mudo");
- Indicación acústica de confirmación de accionamiento del pulsador que se puede desactivar;
- Soporte para memoria externa: microSD (función posible sólo si el videointerfono está instalado apoyado en la pared);
- Funciones calendario y reloj con tiempo de backup de 2 horas en ausencia de alimentación de red;
- Posibilidad de reemplazar la carátula de pulsadores del videointerfono por otras de distinto color;
- Preparación para el encendido de las luces de las escaleras mediante relé;
- Aplicaciones de Home Automation (Yokis);
- Detección y ajuste de la temperatura dentro de la habitación (función termostato) con sonda de temperatura opcional;
- Posibilidad de indicar la presencia de correo en el buzón (función LETTERBOX, disponible sólo en el videointerfono "Master" con dispositivos opcionales);
- Indicación mediante led de: videointerfono encendido, llamada o conversación en curso, función "mudo" activa, activación de módulo radio Yokis, puerta de entrada que quedó abierta, apertura automática de la puerta activada, función de reenvío de llamada activa, función de alarma activada, alarma en curso, presencia de correo en el buzón (función LETTERBOX), presencia de nuevos mensajes audio (POST-IT), presencia de nuevos mensajes vídeo grabados;
- Posibilidad de consultar la cronología de eventos de las funciones de control de accesos y alarmas.

### **Funciones básicas**













- Llamada videointerfónica desde el microaltavoz;
- Activación de la cerradura eléctrica para peatones y segunda cerradura (pasaje para vehículos), sólo a continuación de una llamada o de una autoactivación;
- Función de autoactivación audio/vídeo en el teclado;
- Llamada intercomunicante entre videointerfonos individuales dentro del mismo apartamento;
- Llamada intercomunicante grupal a todos los videointerfonos pertenecientes al mismo apartamento;
- Llamada intercomunicante grupal entre videointerfonos de distintos apartamentos (función disponible sólo con el kit ref. 1723/96).













### **Funciones adicionales**

- Posibilidad de conectar hasta 4 cámaras TVCC en el sistema con la ayuda de un dispositivo específico;
- Función de autoactivación cíclica en modo automático, de cualquier videointerfono, en los puestos de llamada, en la propia cámara local y en las cámaras TVCC presentes en el sistema;
- Sólo en el videointerfono "Master" es posible:
  - Activar la función de reenvío de una llamada audio-vídeo, o solo audio, a un smartphone o tableta con sistema operativo Android o iOS;
  - Activar un contestador videointerfónico capaz de grabar hasta 32 mensajes vídeo de 10 seg.;
  - Enviar un mensaje audio previamente grabado a la persona que llama (duración máxima 20 seg.);
  - Activar una grabación sólo vídeo en sincronía con la llamada (hasta 32 grabaciones de 20 seg.);
- Posibilidad de grabar breves mensajes de audio (POST-IT) en cualquier videointerfono del sistema (máx. 32

















- mensajes de 20 seg.);
- Posibilidad de activar la cerradura eléctrica para peatones en automático a continuación de una llamada;
- Posibilidad de grabación vídeo y memorización también en tarjeta microSD;
- Posibilidad de exclusión del micrófono;
- Posibilidad de ver la fecha y la hora, con la función adicional de agenda;
- Detección de una alarma:
  - Indicación con led y emisión de tono acústico en el videointerfono;
  - Repetición de la indicación acústica en una sirena;
  - Activación de una cámara para captar las imágenes con grabación automática de un mensaje vídeo;
- Activación de módulos radio Yokis desde cualquier videointerfono;
- Programación de las activaciones de los módulos radio Yokis en una o más ocasiones semanales;
- Desviación de la llamada y/o de alarma a smartphone, con dispositivo específico.
- Posibilidad de actualizar el firmware del sistema a través de la tarjeta microSD.















## 2 COMPOSICIÓN DEL KIT

	Descripción	Nº	ID	
Teclado (A)	Teclado Mod. MIKRA2 con 1 pulsador de llamada (presente sólo en el kit ref. 1723/95)	1		A1
	Teclado Mod. MIKRA2 con 2 pulsadores de llamada (presente sólo en el kit ref. 1723/96)	1		A2
	Tornillos para la fijación en la pared (ø 3,5 x 32 mm)	4		A3
	Tacos de fijación en la pared (ø 5 mm)	4		A4
	Accesorio para destornillador (ø 2 mm)	1		A5
	Tarjetero para nombres gris (cantidad: 1 en el kit ref. 1723/95, cantidad: 2 en el kit ref. 1723/96)	1/2		A6
	Tarjetero para nombres transparente (cantidad: 1 en el kit ref. 1723/95, cantidad: 2 en el kit ref. 1723/96)	1/2		A7
	Tornillo Allen de repuesto para el cierre del teclado (M3 x 12 mm)	1		A8
	Llave Master MIFARE para programación	1		A9
	Llaves transpondedor MIFARE (cantidad: 5 en el kit ref. 1723/95, cantidad: 10 en el kit ref. 1723/96)	5/10		A10
	Chip tag (cantidad: 2 en el kit ref. 1723/95, cantidad: 4 en el kit ref. 1723/96)	2/4		A11
	Pantalla de ferrita para chip tag (cantidad: 2 en el kit ref. 1723/95, cantidad: 4 en el kit ref. 1723/96)	2/4		A12
	Manual de instrucciones del chip tag (cantidad: 1 en el kit ref. 1723/95, cantidad: 2 en el kit ref. 1723/96)	1/2		A13

Aparato interior (B)	Videointerfono Mod. VMODO "Master" (cantidad: 1 en el kit ref. 1723/95, cantidad: 2 en el kit ref. 1723/96)	1/2		B1
	Soporte para la fijación de pared (cantidad: 1 en el kit ref. 1723/95, cantidad: 2 en el kit ref. 1723/96)	1/2		B2
	Tornillos para la fijación en la pared (ø 2,9 x 32 mm) (cantidad: 4 en el kit ref. 1723/95, cantidad: 8 en el kit ref. 1723/96)	4/8		B3
	Tacos de fijación en la pared (ø 5 mm) (cantidad: 4 en el kit ref. 1723/95, cantidad: 8 en el kit ref. 1723/96)	4/8		B4
	Tornillos para la fijación en caja para empotrar Mod. 503 (M3,5 x 19 mm) (cantidad: 2 en el kit ref. 1723/95, cantidad: 4 en el kit ref. 1723/96)	2/4		B5
	Palanca de extracción del frente del videointerfono (cantidad: 1 en el kit ref. 1723/95, cantidad: 2 en el kit ref. 1723/96)	1		B6
	Cable de 6 vías para la conexión de dispositivos opcionales (cantidad: 1 en el kit ref. 1723/95, cantidad: 2 en el kit ref. 1723/96)	1/2		B7
	Tableros de bornes extraíbles para la conexión del videointerfono en el sistema (cantidad: 2 en el kit ref. 1723/95, cantidad: 4 en el kit ref. 1723/96)	2/4		B8
	Cable de 2 vías para la conexión de una sonda de temperatura opcional (cantidad: 1 en el kit ref. 1723/95, cantidad: 2 en el kit ref. 1723/96)	1/2		B9
Alimentador (C)	Alimentador del sistema	1		C1
	Inductancia audio vídeo	1		C2
(D)	Distribuidor vídeo (sólo en el kit ref. 1723/96)	1		D

### 3 DISPOSITIVOS ACCESORIOS

Descripción		Nº máx. (considerando la configuración máxima del sistema)	ID
Cerradura eléctrica (12 V~ Máx. 15 VA)	-	2 (una por teclado)	 OP1
Pulsador de accionamiento de la cerradura eléctrica para peatones	-	2 (uno por teclado)	 OP2
Contactos del relé para la activación de la apertura de la puerta del pasaje para vehículos (máx. corriente conmutable 1 A @ 30 V)	-	2 (uno por teclado)	 OP3
Sensor de puerta abierta	ref. 1033/701	2 (uno por teclado)	 OP4 (*)
Timbre radio (disponible sólo para el mercado francés)	cod. 43410	12 (3 por videointerfono)	 OP5 (**)
Timbre adicional (máx. 4 con kit ref. 1723/95, máx. 8 con kit ref. 1723/96)	ref. 9854/43	4/8 (uno por videointerfono)	 OP5A (**)
Videointerfonos "Slave" adicionales Mod. VMODO 7" manos libres (máx. 3 con kit ref. 1723/95, máx. 6 con kit ref. 1723/96)	ref. 1723/97	3/6	 OP6
Sensor de alarma magnético	ref. 1033/701	2 (uno por videointerfono Master)	 OP7
Sensores de presencia (NC en ausencia de indicación)	ref. 1033/012 ref. 1033/132	4 (dos por videointerfono Master)	 OP7a (#)
Pulsador de llamada al piso	-	2 (uno por videointerfono Master)	 OP8
Teclado secundario monofamiliar Mod. MIKRA2	ref. 1723/11	1	 OP9
Teclado secundario bifamiliar Mod. MIKRA2	ref. 1723/12	1	 OP10
Teclado para el control de accesos	ref. 1723/46	2 (uno por teclado)	 OP11
Kit para empotrar para teclado	ref. 1723/50	2 (uno por teclado)	 OP12
Caja relés para 2 teclados	ref. 1723/51	1	 OP13
Soporte de sobremesa para videointerfono 7" manos libres (máx. 4 con kit ref. 1723/95, máx. 8 con kit ref. 1723/96)	ref. 1723/52	4/8	 OP14
Kit para empotrar para videointerfono 7" manos libres (máx. 4 con kit ref. 1723/95, máx. 8 con kit ref. 1723/96)	ref. 1723/60	4/8	 OP16

Interfaz TVCC	ref. 1723/69	1		OP17
Dispositivo vídeo BALUN pasivo de 1 canal	ref. 1092/300A	4 (uno por cada cámara conectada a la interfaz TVCC)		
Kit de llaves Mifare	ref. 1723/102	un máximo de 21 llaves en el sistema		OP18
Cámara compacta AHD DAY & NIGHT con óptica fija 3,6 mm (máx. 4 con kit ref. 1723/95, máx. 8 con kit ref. 1723/96)	ref. 1092/250A	4/8 (una por videointerfono)		OP19 (#)
Dispositivo vídeo BALUN pasivo de 1 canal	ref. 1092/300A	4/8 (uno por cada cámara ref. 1092/250A)		
Salida programable que se puede activar: - después del accionamiento del pulsador Home Automation (función predeterminada: luz de las escaleras), - después de un evento de alarma, - por la función termostato.	-	-		OP20 (**)
Relé temporizable 2000 W	cód. 5454462	uno por kit		OP21 (*)
Relé con bobina de 230 V~	cód. 5454081	uno por kit		
Transmisor 2 canales para pulsadores Mod. E2BPP	cód. 5454413	1 (sólo para el kit ref. 1723/95)		
Transmisor 4 canales para pulsadores Mod. E4BPP	cód. 5454427	2 (sólo para el kit ref. 1723/96)		
Sensor de alarma magnético (cantidad: 2 en el kit ref. 1723/95, cantidad: 4 con el kit ref. 1723/96)	ref. 1033/701	2/4		
Sonda de temperatura Yokis THERMPROBE (máx. 4 con kit ref. 1723/95, máx. 8 con kit ref. 1723/96)	cód. 5454488	4/8 (una por videointerfono)		OP22
Alimentador para cámara tipo ref. 1092/250A	ref. 1092/800	4 (uno por cámara cuando se utiliza la interfaz TVCC ref. 1723/69)		OP23
Transformador local para 1723/97 (cantidad: 2 en el kit ref. 1723/95, cantidad: 6 con el kit ref. 1723/96)	ref. 1723/22	2/6 (uno ogni videocitofono Slave)		C4
Distribuidor vídeo (presente sólo en el kit ref. 1723/96)	ref. 1723/55	1		D

(\*) Las dos opciones se excluyen recíprocamente.

(\*\*) Para mayores detalles, consultar el apartado 7.5 - FUNCIONES Y CONFIGURACIÓN DE LOS RELÉS

(#) Las dos opciones se excluyen recíprocamente.



## 4 PIEZAS DE REPUESTO

Descripción	Ref.	ID	Descripción	Ref.	ID
Alimentador del sistema	Ref. 1723/20	C1	Videointerfono "Master" 7" manos libres Mod. VMODO	Ref. 1723/98	B1
Inductancia audio vídeo	Ref. 1723/112	C2	Teclado Mod. MIKRA2 con 1 pulsador de llamada (solo en el kit ref. 1723/95)	Ref. 1723/11	A1
Distribuidor vídeo	Ref. 1723/55	D	Teclado Mod. MIKRA2 con 2 pulsadores de llamada (solo en el kit ref. 1723/96)	Ref. 1723/12	A2

## 5 DIAGRAMA DE BLOQUES DE CONEXIÓN

### 5.1 SISTEMA MONOFAMILIAR

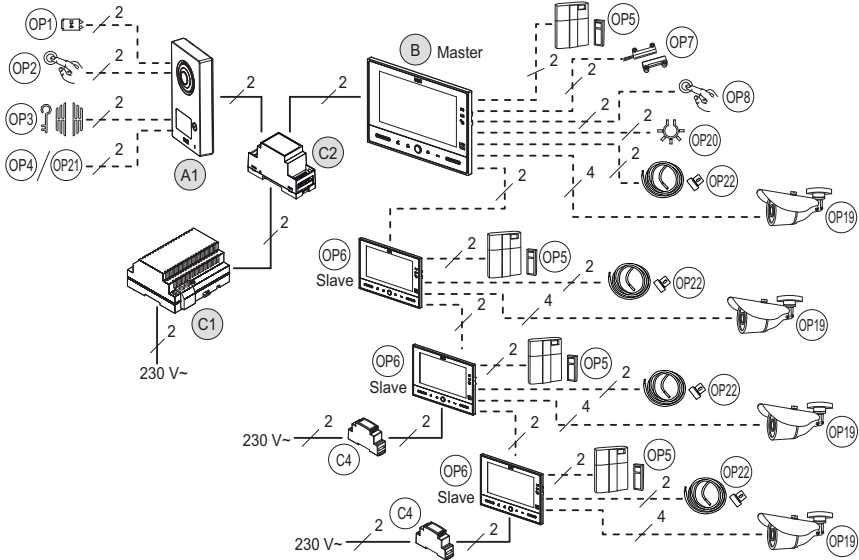

#### 5.1.1 Distancias máximas entre los dispositivos

Tramo	Tipo de cable					
	SYT1-3P-AWG20 (Ø 0,8 mm)	Par trenzado telefónico Ø 0,6 mm sin vaina	CAT5	1,5 mm <sup>2</sup> individual	2Voice	PTT278
A1 – C2	150 m	150 m	100 m	75 m	200 m	100 m
C1 – C2	0,5 m	0,5 m	0,5 m	0,5 m	0,5 m	0,5 m
C2 – videointerfono más distante (OP6)	50 m	50 m	50 m	20 m	50 m	50 m
A – OP1	10 m	10 m	10 m	20 m	20 m	10 m
A – OP2	50 m	50 m	30 m	50 m	50 m	50 m
A – OP3	10 m	10 m	10 m	20 m	20 m	10 m
A – OP4	25 m	25 m	25 m	25 m	25 m	25 m
A – OP21	10 m	10 m	10 m	10 m	10 m	10 m
B – OP5	30 m	30 m	30 m	30 m	30 m	30 m
B – OP7	30 m	30 m	30 m	30 m	30 m	30 m
B – OP8	30 m	30 m	30 m	30 m	30 m	30 m
B – OP19	-	-	50 m	-	-	-
B – OP20	30 m	30 m	30 m	30 m	30 m	30 m
OP6 – C4	20 m	10 m	10 m	30 m	20 m	20 m
OP6 – OP5	30 m	30 m	30 m	30 m	30 m	30 m

Los cables utilizados deben responder a la norma IEC 60332-1-2 si tienen una sección de 0,5 mm<sup>2</sup> o superior, o a la norma IEC 60332-2-2 si la sección es inferior a 0,5 mm<sup>2</sup>.

## 5.2 SISTEMA BIFAMILIAR

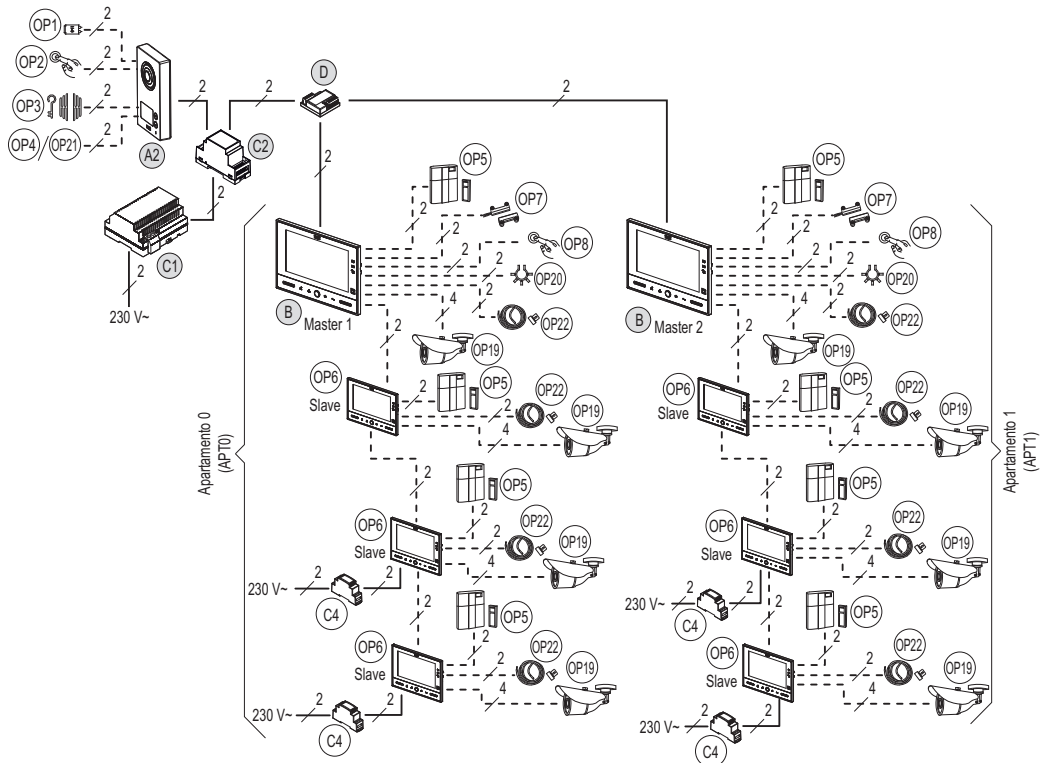

### 5.2.1 Distancias máximas entre los dispositivos

Tramo	Tipo de cable					
	SYT1-3P-AWG20 (Ø 0,8 mm)	Par trenzado telefónico Ø 0,6 mm sin vaina	CAT5	1,5 mm <sup>2</sup> individual	2Voice	PTT278
A2 – C2	150 m	150 m	100 m	75 m	200 m	100 m
C1 – C2	0,5 m	0,5 m	0,5 m	0,5 m	0,5 m	0,5 m
C2 – D	5 m	5 m	5 m	5 m	5 m	5 m
C2 – videointerfono más distante (OP6)	50 m	50 m	50 m	20 m	50 m	50 m
A – OP1	10 m	10 m	10 m	20 m	20 m	10 m
A – OP2	50 m	50 m	30 m	50 m	50 m	50 m
A – OP3	10 m	10 m	10 m	20 m	20 m	10 m
A – OP4	25 m	25 m	25 m	25 m	25 m	25 m
A – OP21	10 m	10 m	10 m	10 m	10 m	10 m
B – OP5	30 m	30 m	30 m	30 m	30 m	30 m
B – OP7	30 m	30 m	30 m	30 m	30 m	30 m
B – OP8	30 m	30 m	30 m	30 m	30 m	30 m
B – OP19	-	-	50 m	-	-	-
B – OP20	30 m	30 m	30 m	30 m	30 m	30 m
OP6 – C4	20 m	10 m	10 m	30 m	20 m	20 m
OP6 – OP5	30 m	30 m	30 m	30 m	30 m	30 m

Los cables utilizados deben responder a la norma IEC 60332-1-2 si tienen una sección de 0,5 mm<sup>2</sup> o superior, o a la norma IEC 60332-2-2 si la sección es inferior a 0,5 mm<sup>2</sup>.

## 6 ADVERTENCIAS PARA EL INSTALADOR

---

Leer atentamente las advertencias contenidas en este documento, ya que brindan indicaciones importantes referidas a la seguridad de instalación, uso y mantenimiento.

- Los dispositivos que forman parte del kit se deben destinar sólo al uso para el que han sido expresamente diseñados. Cualquier otro uso se debe considerar impropio. El fabricante no se considera responsable de posibles daños que deriven de un uso impropio o desatinado.
- Cada pieza ha sido diseñada para responder a las normas vigentes.
- La ejecución del sistema debe responder a las normas vigentes. Todos los aparatos que componen el sistema deben estar destinados exclusivamente al uso para el que han sido diseñados.
- Después de retirar los distintos componentes del embalaje, comprobar que estén intactos.
- Los elementos del embalaje (bolsas de plástico, poliestireno expandido, etc.) no se deben dejar al alcance de niños, ya que son fuentes potenciales de peligro.
- Prever antes de los aparatos un interruptor de seccionamiento y de protección apropiado, con una distancia de apertura de los contactos al menos de 3 mm.
- Antes de conectar los dispositivos de alimentación, asegurarse de que los datos de placa coincidan con los de la red de distribución.
- No obstruir las aberturas o rendijas de ventilación o eliminación del calor.
- Antes de realizar cualquier operación de limpieza o de mantenimiento, desconectar los dispositivos de la red de alimentación eléctrica, apagando el interruptor del sistema.
- No usar productos en aerosol para la limpieza.
- En caso de desperfecto y/o de mal funcionamiento de los productos contenidos en el kit, cortar la alimentación mediante el interruptor general y no alterarlo.
- Para una posible reparación, dirigirse solamente a un centro de asistencia técnica autorizado por el fabricante.
- Prever una ventilación adecuada.
- No usar cables prolongadores para el cable de la red de alimentación.
- En caso de entrada de líquidos u objetos dentro del aparato, confiarlo a personal cualificado para el control y la posible reparación.
- Para las reparaciones usar exclusivamente las piezas de repuesto entregadas por la empresa.
- El instalador debe asegurarse de que las informaciones para el usuario estén presentes en los aparatos derivados.
- La falta de respeto de estas indicaciones puede comprometer la seguridad de la instalación.
- Este documento deberá entregarse siempre junto con el aparato.
- El símbolo del rayo con una flecha dentro de un triángulo equilátero indica la presencia de tensiones peligrosas.



- No abrir los dispositivos si no está expresamente indicado en este manual de instrucciones.
- El signo de exclamación dentro de un triángulo equilátero indica componentes críticos para la seguridad, usar pues sólo componentes suministrados por la empresa.



# 7 INSTALACIÓN DEL VIDEOINTERFONO

## 7.1 DESCRIPCIÓN DE LOS COMPONENTES

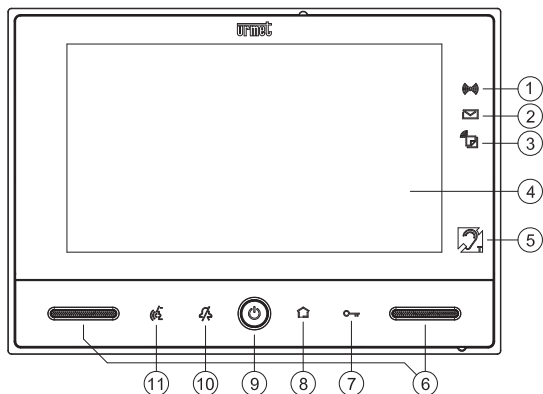

### Delantero:

1. Icono de alarma
2. Icono de indicación de presencia de correo en el buzón (función LETTERBOX)
3. Icono indicación contestador automático activo (verde fijo) / presencia de mensajes audio POST-IT (rojo parpadeante) / función de reenvío de llamada activa (amarillo fijo) (solo en videointerfono master Ref. 1723/98)
4. Pantalla 7"
5. Icono que indica que el videointerfono tiene la repetición de fonía para hipoacúsicos (ILA)
6. Altavoces
7. Pulsador (táctil) de apertura de la puerta
8. Icono de confirmación de recepción de mando Yokis
9. Pulsador de encendido / OFF
10. Pulsador (táctil) "MUDO"
11. Pulsador (táctil) de activación de la fonía

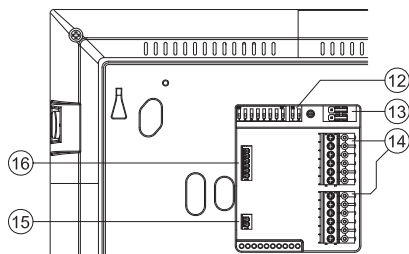

### Parte trasera:

12. Interruptor dip de configuración
13. Puentes
14. Tableros de bornes extraíbles de 6 vías
15. Conector de 2 vías para termostato externo
16. Conector de 6 vías para la conexión de cámara externa / relé 2 (OP20)

## 7.2 MODO DE INSTALACIÓN

- Fijar el soporte en la pared utilizando una caja 503 y los tornillos entregados con el equipo, o una caja  $\varnothing$  60 con tornillos apropiados.
- Programar los interruptores dip y conectar en los tableros de bornes los conductores del sistema.
- Enganchar el videointerfono en el soporte, en los 4 ganchos presentes sobre los lados.
- Retirar la película de protección de la pantalla.

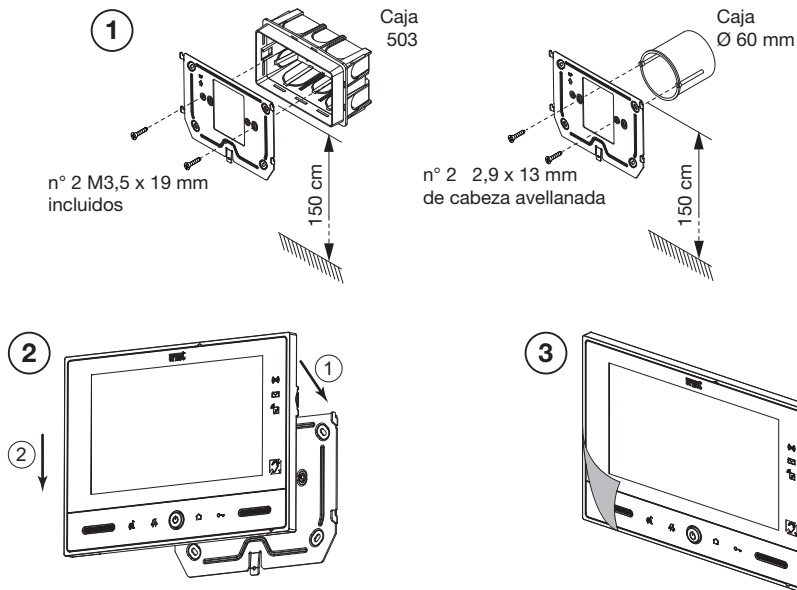

Retirar la película de protección de la pantalla del videointerfono.

## 7.3 DESCRIPCIÓN DE LOS TABLEROS DE BORNES

Tablero de bornes	Nombre del borne	Descripción
	LI	Entrada Bus (LINE IN)
	LI	
	LO	Salida Bus (LINE OUT)
	LO	
	LP	24 V~ alimentación local
	LP	
	FC	Llamada al piso
	FC	
	0	Timbre adicional (salida relé 1 – OP5 / OP5A)
	C	
	AL	Entrada sensor de alarma
	AL	

## 7.4 DESCRIPCIÓN DEL CONECTOR PARA LA CÁMARA EXTERNA / RELÉ 2 (OP20)

Es posible conectar al videointerfono "Master" la cámara externa ref. 1092/250A mediante el cable (B7) entregado con el equipo.

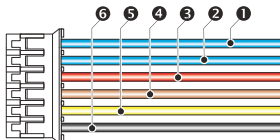

N. hilo	Color hilo	Descripción	Nombre del pin en el conector
1	Azul	Luces de las escaleras (salida relé 2 – OP20)	RELAY SPARE
2	Azul	Luces de las escaleras (salida relé 2 – OP20)	RELAY SPARE
3	Rojo	Positivo alimentación cámara	CCTV POWER+
4	Marrón	Negativo de la señal en salida del video balun	CCTV VIDEO-
5	Amarillo	Positivo de la señal en salida del video balun	CCTV VIDEO+
6	Negro	Negativo alimentación cámara TV	CCTV POWER-

## 7.5 FUNCIONES Y CONFIGURACIÓN DE LOS RELÉS

El videointerfono cuenta con dos relés programables como se indica en la tabla siguiente:

Relè	Función posible	Predeterminado	Referencia
1	Timbre adicional	✓	OP5 / OP5A
	Pulsador Home Automation 1		
	Alarma sirena		
2	Pulsador Home Automation 2	✓	OP20
	Alarma sirena		
	Salida termostato		

## 7.6 CONFIGURACIÓN DE LOS PUENTES (JP1 y JP2)

En el videointerfono hay dos puentes:

- JP1: permite activar el extremo de línea. Es necesario activar el extremo de línea en el videointerfono conectado al final de una línea que no reinicie con un nuevo tramo desde los bornes LINE OUT.

	JP1
Extremo activado (predeterminado)	
Extremo desactivado	

- JP2: permite alimentar el videointerfono desde la Línea Bus o a través de un transformador local ref. 1723/22.



	JP2
Alimentación desde línea Bus (predeterminado)	
Alimentación desde transformador local	

## 7.7 CONFIGURACIÓN DE LOS INTERRUPTORES DIP

El videointerfono tiene 8 interruptores dip en la parte trasera del dispositivo.



- ⚠ Los interruptores dip 5, 7 y 8 no se usan.

### 7.7.1 Asociación de un pulsador de llamada al videointerfono

	Posición interruptor dip 1		Posición interruptor dip 1
Videointerfono asociado al pulsador de llamada 0 (superior)		Videointerfono asociado al pulsador de llamada 1 (inferior)	

### 7.7.2 Código del videointerfono

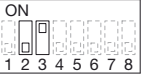
Para instalar videointerfonos “Slave” es necesario configurar en cada aparato interior el código correspondiente a través de los interruptores dip 2 y 3.



Tipo de videointerfono	Posición interruptor dip 2 y 3	Tipo de videointerfono	Posición interruptor dip 2 y 3
Videointerfono “Master”		Videointerfono “Slave” n° 1	
Videointerfono “Slave” n° 2		Videointerfono “Slave” n° 3	

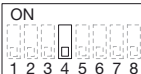
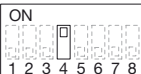

### 7.7.3 Tipo de sistema

	Posición interruptor dip 4		Posición interruptor dip 4
Sistema monofamiliar		Sistema bifamiliar	



### 7.7.4 Activación de la fonía accionando el pulsador (modo “Push to talk”)

Si no hay comunicación entre el teclado y el videointerfono, o si tiene algún disturbio, comprobar que se haya retirado la película transparente que cubre la pantalla del videointerfono. Si se retiró la película y los disturbios de sonido subsisten, es posible activar los dos canales de fonía (hacia el interior y hacia el exterior) de forma individual.

Después de recibir una llamada, accionar brevemente  para activar la fonía desde el aparato exterior; luego, si se mantiene accionado el pulsador , se activa el canal audio hacia el exterior y se puede hablar con la persona que llama. Para escuchar se debe soltar el pulsador .

	Posición interruptor dip 6		Posición interruptor dip 6
Función desactivada		Función activada	

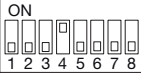
### 7.7.5 Configuraciones de fábrica

<b>Kit monofamiliar ref. 1723/95:</b>	Videointerfono	
<b>Kit bifamiliar ref. 1723/96:</b>	Videointerfono 1	
	Videointerfono 2	

## 8 INSTALACIÓN DEL ALIMENTADOR DEL SISTEMA Y DE LA INDUCTANCIA AUDIO VIDEO

El alimentador se debe instalar dentro de un tablero eléctrico o de un armario.

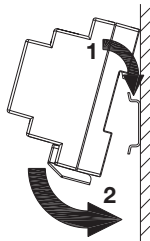

Instalación en barra DIN (6 módulos de 18 mm)

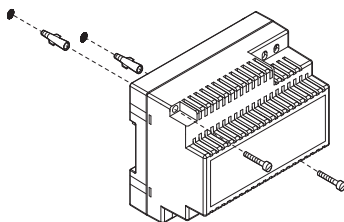

Instalación con apoyo de pared

El módulo inductancia se puede fijar en la pared utilizando el soporte entregado con el equipo y se puede fijar en barra DIN (2 módulos de 18 mm).

El módulo inductancia se debe instalar en el mismo tablero eléctrico que el alimentador.

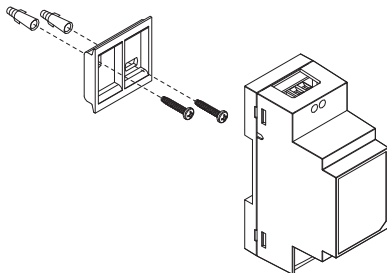

### 8.1.1 Descripción de los bornes

Alimentador del sistema ref. 1723/20

- |   |               |   |
|---|---------------|---|
| ⊗ | 110-230V~ / N | } Entrada tensión de alimentación de red 110-230 V~ |
| ⊗ | -             |   |
| ⊗ | +             | } Salida tensión de alimentación                    |
| ⊗ | -             |   |

Inductancia audio vídeo ref. 1723/112

- |   |   |                                   |             |
|---|---|-----------------------------------|-------------|
| ⊗ | + | } Entrada tensión de alimentación |             |
| ⊗ | - |                                   |             |
| ⊗ | ] | LINE1                             | Línea BUS 1 |
| ⊗ |   | LINE2                             | Línea BUS 2 |



## 9 INSTALACIÓN DEL TECLADO

### 9.1 DESCRIPCIÓN DE LOS COMPONENTES

Teclado Mod. MIKRA2 con 1 pulsador de llamada  
(presente sólo en el kit monofamiliar ref. 1723/95)

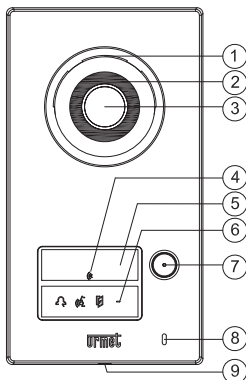

Teclado Mod. MIKRA2 con 2 pulsadores de llamada  
(presente sólo en el kit bifamiliar ref. 1723/96)

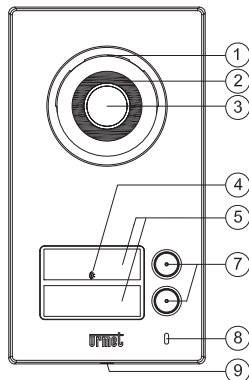

Delantero:

1. Altavoz
2. Led de iluminación cámara
3. Cámara
4. Lector transpondedor
5. Tarjetero/s para nombres
6. Indicaciones led específicas de la función DDA
7. Pulsador/pulsadores de llamada
8. Micrófono
9. Tornillo de cierre del frente

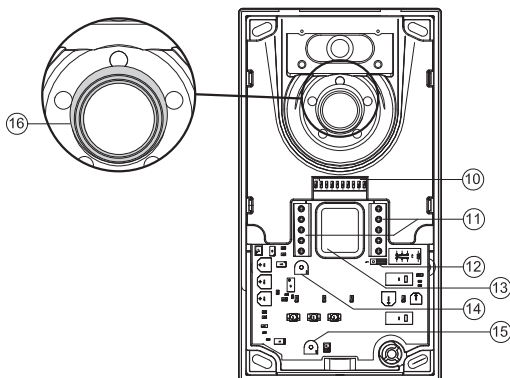

Parte interior:

10. Interruptor dip de configuración
11. Tableros de bornes
12. **¡No variar la posición de este puente!**
13. Orificio para el paso de cables
14. Trimmer de regulación del nivel fónico del altavoz
15. **¡No girar este trimmer!**
16. Junta antirreflejo

## 9.2 MODO DE INSTALACIÓN

- Instalar el teclado a la altura indicada, comprobando que la persona entre en el campo de toma de la cámara
- Conectar los cables en los tableros de bornes
- Montar los soportes de las tarjetas para nombres en la parte delantera
- Realizar las programaciones
- Si fuera necesario, ajustar el nivel fónico del altavoz
- Cerrar el teclado con la cubierta metálica
- Retirar las películas de protección

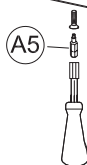
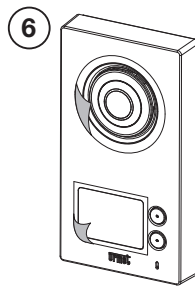
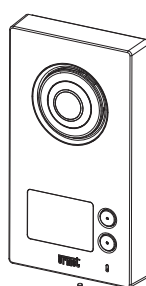
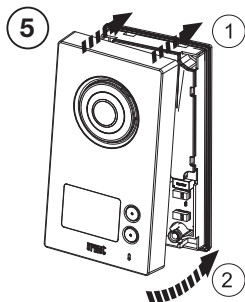
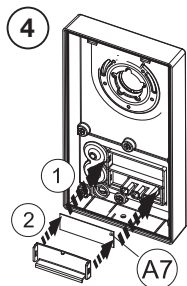
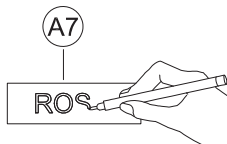
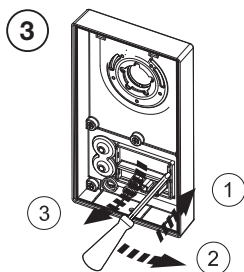
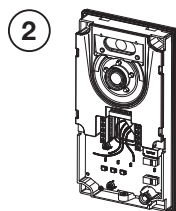
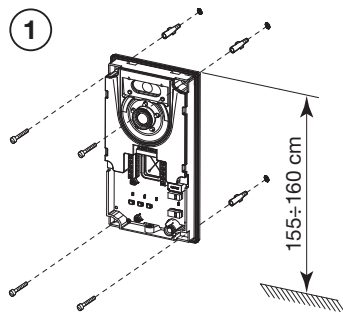
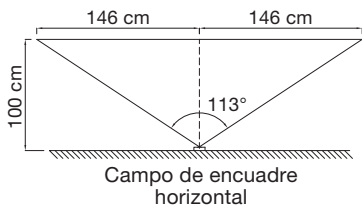
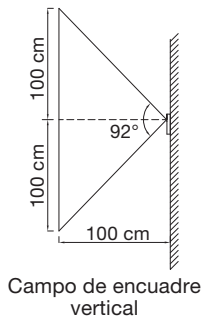

### 9.3 DESCRIPCIÓN DE LOS BORNES

#### Tablero de bornes izquierdo

- ⊗ SE- Negativo de accionamiento cerradura eléctrica con descarga capacitiva
- ⊗ SE+ Positivo de accionamiento cerradura eléctrica con descarga capacitiva
- ⊗ } PA Entrada para pulsador de la cerradura eléctrica para peatones
- ⊗ SP Entrada para sensor específico para la función ESTADO PUERTA o LETTERBOX

#### Tablero de bornes derecho



- ⊗ SP Entrada para sensor específico para la función ESTADO PUERTA o LETTERBOX
- ⊗ } LINE Línea bus
- ⊗ } N.O. Accionamiento contacto limpio apertura de la puerta (OP3)

### 9.4 CONFIGURACIÓN DE LOS INTERRUPTORES DIP



El teclado tiene 10 interruptores dip en el interior del dispositivo.

**Los interruptores dip 6, 9 y 10 no se deben modificar.**



#### 9.4.1 Selección de la función ESTADO PUERTA o LETTERBOX (indicación de presencia de correo en el buzón)

	Posición interruptor dip 1		Posición interruptor dip 1
Función ESTADOPUERTA activada		Función LETTERBOX activada	



#### 9.4.2 N° de identificación del teclado

	Posición interruptor dip 2		Posición interruptor dip 2
Teclado 1		Teclado 2	



#### 9.4.3 Encendido de los leds de la cámara en fase de llamada

	Posición interruptor dip 3		Posición interruptor dip 3
Función activada		Función desactivada	

#### 9.4.4 Habilitación para la llamada del apartamento 0 con los dos pulsadores presentes en el teclado (función disponible sólo con kit bifamiliar ref. 1723/96)

	Posición interruptor dip 4		Posición interruptor dip 4
Función desactivada		Función activada	



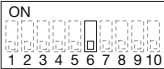
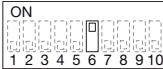

#### 9.4.5 Selección del tipo de activación de la cerradura eléctrica para peatones y del pasaje para vehículos: con descarga capacitiva o de relé con contactos limpios

	Posición interruptor dip 5		Posición interruptor dip 5
Activación de la cerradura eléctrica para peatones con descarga capacitiva de impulso y corriente de mantenimiento (bornes SE+ y SE-); activación del pasaje para vehículos mediante relé con contactos limpios (bornes N.O.).		Activación de la cerradura eléctrica para peatones mediante relé con contactos limpios (bornes N.O.); activación del pasaje para vehículos con descarga capacitiva de impulso y corriente de mantenimiento (bornes SE+ y SE-).	



### 9.4.6 Configuración del tipo de teclado

	Posición interruptor dip 6		Posición interruptor dip 6
Teclado monofamiliar		Teclado bifamiliar	

### 9.4.7 Regulación del tiempo de activación de la cerradura eléctrica con descarga capacitiva

	Posición interruptor dip 7-8		Posición interruptor dip 7-8
0 segundos (impulso de 300 ms)		3 segundos	
6 segundos		9 segundos	

### 9.4.8 Configuraciones de fábrica

Kit monofamiliar ref. 1723/95:	Teclado 1	
Kit bifamiliar ref. 1723/96:	Teclado 2	

## 9.5 REGULACIÓN DEL NIVEL FÓNICO DEL ALTAVOZ

Los niveles fónicos están calibrados de fábrica, para que no haga falta modificarlos en la mayor parte de las instalaciones.

Si fuera necesario modificarlos, actuar con un destornillador en el correspondiente ajuste del volumen del altavoz (ver el punto 14 del apartado 9.1 - DESCRIPCIÓN DE LOS COMPONENTES).

## 10 CARACTERÍSTICAS TÉCNICAS

### Alimentador del sistema

Alimentador en CAT III 4000 V

Alimentación: .....	<b>110-230 V~ 50-60 Hz</b>
Potencia: .....	<b>75 W máx.</b>
Salida secundario: .....	<b>50 V --- 1 A</b>
Potencia absorbida después de 1 hora de funcionamiento: .....	<b>Máx. 5 Wh (18 kJ)</b>
Dimensiones (A x A x F): .....	<b>108 (6 módulos DIN) x 90 x 61 mm</b>

### Inductancia audio vídeo

Dimensiones (A x A x F): .....	<b>36 (2 módulos DIN) x 95 x 57 mm</b>
--------------------------------	--

### Videointerfono

Tensión de alimentación: .....	<b>de BUS 37÷48 V ---</b>
	<b>De transformador local 24 V~ (+-10%)</b>
Absorción: máxima .....	<b>280 mA @ 48 V ---</b>
en reposo (configuración básica) .....	<b>25 mA @ 48 V ---</b>
Potencia absorbida en funcionamiento: .....	<b>máx 16 W</b>
Pantalla de cristal líquido: .....	<b>7" IPS iluminada en la cara posterior</b>
Resolución: .....	<b>1024H x 600V pixel</b>
Ángulo de visual .....	<b>&gt;±80°</b>
Retardo de encendido: .....	<b>2 seg. Máx.</b>
Cápsula transmisora: .....	<b>micrófono de electretes</b>
Cápsula receptora: .....	<b>altavoz 45 Ω</b>
Soporte para memoria externa: .....	<b>microSD estándar (recomendado 2 GB)</b>
Alcance radio:	<ul style="list-style-type: none"> <li>• dentro de una casa de 100m<sup>2</sup> donde atravesase un muro portante perpendicular o una losa;</li> <li>• 250 m en ausencia de obstáculos.</li> </ul>
	<i>🔪 En ambos casos, reducción del alcance en presencia de elementos metálicos, paredes o tabiques.</i>

Transmisión radio: el led del transmisor sólo se enciende si la transmisión se pudo establecer correctamente. Si el alcance no es suficiente, el añadido del receptor intermedio permite resolver el problema. Consultar el manual de instrucciones de los transmisores Yokis.

Banda de frecuencia:

WiFi: ..... 2400 ÷ 2483,5 MHz  
 Yokis: ..... 2400 ÷ 2480 MHz  
 Mifare: ..... 13,56 MHz

Potencia de salida (máx.):

WiFi: ..... 20 dBm  
 Yokis: ..... 10 dBm  
 Mifare: ..... -13 dBµA/m @ 10m

Salida relé 1 (OP5 / OP5A) ..... 100 mA @ 24 V ---

Salida relé 2 (OP20 - RELAY SPARE) ..... 25 mA @ 24 V ---

Temperatura de funcionamiento: ..... -5 ÷ +45° C

Humedad máx.: ..... 95% UR

Dimensiones (A x A x F): ..... 202 x 142 x 22 mm

### Teclado

Tensión de alimentación: ..... 36÷48 V ---

Absorción: máxima ..... 130 mA @ 48 V ---

en reposo ..... 20 mA @ 48 V ---

Potencia máxima absorbida en funcionamiento: ..... máx 6,5 W

Dimensiones (A x A x F): ..... 100 x 180 x 28 mm

Dimensiones tarjetero para nombres: ..... 48,5 x 15,5 mm

Iluminación de los tarjeteros y pulsadores: ..... LEDs blancos

Grado de protección de las cubiertas: ..... IP45

Grado de protección contra impactos mecánicos: ..... IK07

Temperatura de funcionamiento: ..... -10 ÷ +50° C

Humedad máx.: ..... 95% UR





Corriente máxima contacto limpio N.O. (OP3): ..... 1 A @ 30 V ---

Cápsula transmisora: ..... micrófono de electretes

Cápsula receptora: ..... altavoz 16 Ω resistente al agua

⚡ Los cables utilizados deben responder a la norma IEC 60332-1-2 si tienen una sección de 0,5 mm<sup>2</sup> o superior, o a la norma IEC 60332-2-2 si la sección es inferior a 0,5 mm<sup>2</sup>.

## 11 LEYENDA DE LOS SÍMBOLOS

Símbolo	Explicación
---	Tensión de alimentación continua
~	Tensión de alimentación alterno
<b>note 2</b>	Marca comercial del sistema del videointerfono
	Fuente de alimentación con doble aislamiento
	PELIGRO - Presencia de tensión peligrosa
	PELIGRO - Presencia de los componentes críticos de seguridad
	Consulte el manual de instalación del dispositivo

## 12 DECLARACIÓN UE DE CONFORMIDAD SIMPLIFICADA

Por la presente, URMET S.p.A. declara que los tipos de equipos radioeléctricos

**KIT VIDEOINTERFÓNICO DE 2 HILOS MONO Y BIFAMILIAR CON REENVÍO DE LLAMADA**

Ref. 1723/95 y 1723/96 es conforme con la Directiva 2014/53/UE.

El texto completo de la declaración UE de conformidad está disponible en la dirección Internet siguiente: [www.urmet.com](http://www.urmet.com)

**INHALTSVERZEICHNIS**

1	ALLGEMEINE BESCHREIBUNG.....	83
2	ZUSAMMENSETZUNG DES KITS.....	85
3	ZUSÄTZLICHE VORRICHTUNGEN .....	87
4	ERSATZTEILE .....	89
5	BLOCK-ANSCHLUSSDIAGRAMME.....	89
5.1	EINFAMILIENHAUSANLAGE.....	89
5.1.1	Maximale Abstände zwischen den Geräten.....	89
5.2	ZWEIFAMILIENHAUSANLAGE.....	90
5.2.1	Maximale Abstände zwischen den Geräten.....	90
6	WICHTIGE HINWEISE FÜR DEN INSTALLATEUR .....	91
7	INSTALLATION DER VIDEOSPRECHANLAGE.....	92
7.1	BESCHREIBUNG DER BESTANDTEILE .....	92
7.2	INSTALLATION.....	93
7.3	BESCHREIBUNG DER KLEMMENLEISTEN .....	93
7.4	BESCHREIBUNG DES VERBINDERS FÜR DIE EXTERNE KAMERA / RELAIS 2 (OP20).....	94
7.5	RELAISFUNKTIONEN UND KONFIGURATIONEN.....	94
7.6	POLBRÜCKENKONFIGURATION (JP1 und JP2).....	94
7.7	DIP-SWITCH-KONFIGURATION.....	94
7.7.1	Ruftastenzuordnung auf der Videosprechanlage.....	95
7.7.2	Code der Videoanlage.....	95
7.7.3	Anlagentyp .....	95
7.7.4	Aktivierung des Gesprächs durch Betätigen der Taste ("Push to talk"-Modus).....	95
7.7.5	Werkseitige Einstellungen: .....	95
8	INSTALLATION DES SYSTEMNETZTEILS UND DER AUDIO-VIDEO-INDUKTANZ .....	96
8.1.1	Beschreibung der Klemmen.....	96
9	INSTALLATION DES TASTENFELDS .....	97
9.1	BESCHREIBUNG DER BESTANDTEILE .....	97
9.2	INSTALLATION.....	98
9.3	ANSCHLUSSKLEMMEN .....	99
9.4	DIP-SWITCH-KONFIGURATION.....	99
9.4.1	Auswahl der Funktion TÜRSTATUS bzw. LETTERBOX (Anzeige von Post im Briefkasten)....	99
9.4.2	Identifizierungs-Nr. des Tastenfelds .....	99
9.4.3	Einschalten der Leds der Kamera während des Anrufs.....	99
9.4.4	Aktivierung für den Anruf der Wohnung 0 von Seiten beider auf dem Tastenfeld vorhandenen Tasten .....	99
9.4.5	Auswahl der Art der Aktivierung Elektroverriegelung des Eingangs und der Zufahrt, entweder mit kapazitiver Entladung oder mit Relais mit spannungsfreien Kontakten.....	99
9.4.6	Einstellung des Tastenfeldtyps .....	100
9.4.7	Einstellung der Aktivierungsdauer der Elektroverriegelung mit kapazitiver Entladung.....	100
9.4.8	Werkseitige Einstellungen .....	100
9.5	EINSTELLUNG DER LAUTSPRECHERLAUTSTÄRKE .....	100
10	TECHNISCHE EIGENSCHAFTEN.....	100
11	ZEICHENERKLÄRUNG SYMBOLE .....	101
12	VEREINFACHTE EU-KONFORMITÄTSERKLÄRUNG.....	101
13	ANSCHLUSSPLÄNE.....	122
13.1	ANSCHLUSS DES EINFAMILIENHAUS-KITS TYP1723/95 MIT 3 PARALLEL GESCHALTETEN VIDEOSPRECHANLAGEN.....	122
13.2	ANSCHLUSS DES ZWEIFAMILIENHAUS-KITS TYP1723/96 MIT 3 PARALLEL GESCHALTETEN VIDEOSPRECHANLAGEN BEI JEDEM TEILNEHMER.....	124
13.3	ANSCHLUSS DES ZUSÄTZLICHEN LÄUTWERKES AN DIE VIDEOSPRECHANLAGE .....	126
13.4	LEGENDE DER PLÄNE .....	127
13.5	HINWEISE IN VERBINDUNG MIT DEN PLÄNEN.....	129

# 1 ALLGEMEINE BESCHREIBUNG

---

Die Videosprechanlage-Kits Mod. NOTE2 zeichnen sich durch einfache Installation dank der Verwendung von nur zwei nicht polarisierten Drähten für Verbindung zwischen den Geräten aus.

Ihre Modularität gestattet die Implementierung verschiedener Zusatzfunktionen außer den Basisfunktionen des Videosprechanlagensystems und bietet so für alle Ansprüche geeignete Lösungen.

Die Merkmale des Systems für Videosprechanlagen sind die Folgenden:

## System

- Kit für Einfamilienhäuser Typ 1723/95:
  - Gestattet den Einsatz von zwei Videosprechanlagen ohne jegliche Zusatzstromversorgung;
  - Kann bis zu vier Videosprechanlagen (1 "Master" und 3 "Slave") mit Ein-Ausgabe-Verbindung verwalten, die parallel angerufen werden;
- Kit für Zweifamilienhäuser Typ 1723/96:
  - Gestattet den Einsatz von zwei Videosprechanlagen ohne jegliche Zusatzstromversorgung, 1 pro Wohnung;
  - Kann bis zu acht Videosprechanlagen (2 "Master" und 6 "Slave") mit Videoverteiler der Steigleitung und Ein-Ausgabe-Verbindung auf der Etage, die parallel angerufen werden;
- Anschluss aller Geräte mit nur zwei ungepolten Drähten;
- Das Netzteil kann an jeder Systemstelle zwischen Tastenfeld und Videosprechanlage angeschlossen werden;
- Möglichkeit der Verwaltung von bis zu vier Anrufstationen mit automatischer Umschaltung;
- Möglichkeit der Erweiterung der Bus-Länge mittels Zusatzvorrichtung;
- Konfiguration der Geräte über Polbrücken und Dip-Switch;
- Anschlüsse an die Anlage über ausziehbare Klemmleisten.

## Tastenfeld

- Zerstörungssicheres Tastenfeld Mod. MIKRA2 mit wetterbeständiger Frontplatte aus Zamak mit einer oder zwei Tasten;
- Aufputz-Installation (Standard), Möglichkeit der Einbauinstallation mit speziellem Kit;
- Kamera des Tastenfelds in Farbe mit breitem Aufnahmewinkel (wide-angle) und Beleuchtung der Person mittels Led;
- Lesegerät für berührungslose Schlüssel MIFARE;
- Namensschild mit weißer Hintergrundbeleuchtung;
- Aktivierung der Elektroverriegelung des Eingangs mit kapazitiver Entladung mit Impuls und Erhaltungsstrom mit programmierbarer Aktivierungsdauer;
- Auslegung für den Anschluss einer Hausflurtaste zur Aktivierung der Elektroverriegelung der Einfahrt im Raum;
- Auslegung für den Anschluss des Sensors für die Funktion TÜRSTATUS bzw. LETTERBOX ;
- Aktivierung der Elektroverriegelung des Eingangs durch Annäherung der im Lieferumfang enthaltenen berührungslosen Schlüssel;
- Steuerung der Elektroverriegelung über Relais mit spannungsfreien Kontakten;
- Bestätigung der Rufweiterleitung durch akustisches Signal und Ausschalten der Led der Hintergrundbeleuchtung des Schilds;
- Einschalten der Leds der Kamera während des Anrufs mit Ausschlussmöglichkeit;
- Möglichkeit der Lautstärkeregelung des Lautsprechers des Tastenfelds;
- Akustische und visuelle Anzeige des Anlagenstatus (DDA), nur auf Einfamilienhaus-Tastenfeld verfügbar.
- Wasserfestes eingebautes Mikrofon.

## Wohnungseinheit

- Wohnungseinheit der Videosprechanlagen Mod. VMODO mit Freisprechfunktion und 7 Zoll-Farb-LCD-Bildschirm und kapazitivem Touchscreen;
- Aufputz-Installation (Standard), Möglichkeit der Einbauinstallation mit speziellem Kit;
- In mehreren Sprachen verfügbare Benutzerschnittstelle (IT, EN, FR, ES, DE, CS, NL, NO, PL, PT, SK, VLS)
- Freihand-Kommunikationsmodus oder durch Tastenbetätigung ("Push to talk-Modus"):
  - Freihand: Durch Betätigen der Gesprächstaste wird das Gespräch aktiviert und durch ein zweites Betätigen wird es deaktiviert;
  - Push to talk: Wird die Gesprächstaste gedrückt gehalten kann von der Innenstelle aus gesprochen werden, während beim Loslassen der Taste die Hörfunktion einsetzt;

- Rufmelodien: 5 Standard plus 1 vom Benutzer persönlich gestaltbare;
- Möglichkeit der Zuordnung verschiedener Melodien je nach Herkunft des Anrufs (vom Tastenfeld, Intercom, Etagenruf, Alarmmeldung);
- Ausgestattet mit:
  - Gesprächsverstärkungsrichtung für Hörbehinderte (ILA);
  - 2 über Relais konfigurierbare Ausgänge mit spannungsfreien Kontakten zur Aktivierung von Hilfssteuerungen;
  - Hintergrundbeleuchtung der Touch-Tasten mit roter oder grüner Led
- Möglichkeit des direkten Anschlusses an die Videosprechanlage folgender Vorrichtungen:
  - Einer lokalen Überwachungskamera Typ 1092/250A;
  - Einer Etagenruftaste (Nur auf "Master");
  - Eines Temperatursensors Yokis THERMPROBE (Cod. 5454488);
  - Eines Alarmkontakts (Nur auf "Master");
- Möglichkeit, an jede Videoanlage für die Rufwiederholung ein zusätzliches Läutwerk oder einen drahtlosen Rufverstärker anzuschließen (nur für den französischen Markt);
- Möglichkeit der Änderung des Bildseitenverhältnisses von 4:3 auf 16:9;
- Möglichkeit der Audio- (Lautsprecherlautstärke) und Videoeinstellung (Helligkeit, Kontrast und Farbe);
- Einstellbarkeit der Rufauftaste mit der Möglichkeit der zeitweiligen Unterdrückung (Mute-Funktion);
- Ausschließbares akustisches Signal zum Bestätigen des Tastendrucks;
- Unterstützung für externen Speicher: MicroSD (Leistung nur möglich, wenn die Videosprechanlage als Aufputz-Montage installiert ist);
- Kalender- und Uhrfunktionen mit Backup-Zeit von 2 Stunden bei Stromausfall;
- Möglichkeit des Ersetzens der Tastenabdeckung der Videosprechanlage durch andere in unterschiedlicher Farbe;
- Auslegung für das Einschalten des Treppenlichts über Relais;
- Home Automation-Anwendungen (Yokis);
- Messen und Regulierung der Temperatur im Inneren der Wohnung (Thermostatfunktion) mit Temperaturfühleroption;
- Möglichkeit der Anzeige des Vorliegens von Post im Briefkasten (LETTERBOX-Funktion, nur auf "Master"-Videosprechanlage mit Geräteoptionen möglich);
- Anzeige über Led: Videosprechanlage eingeschaltet, Anruf oder Gespräch in Gang, Stummschaltung aktiv, Aktivierung Yokis-Funkmodul, Eingangstür offen geblieben, automatischer Türöffner aktiv, Rufumleitungsfunktion aktiv, Alarmfunktion aktiv, Alarm in Gang, Post im Briefkasten (LETTERBOX-Funktion), neue Audio-Nachrichten (POST-IT), neue aufgezeichnete Videonachrichten;
- Möglichkeit des Einsehens des Ereignisspeichers der Funktionen Zugangskontrolle und Alarm.

### **Basisfunktionen**

- Anruf an die Videoanlage über die Außenstelle;
- Aktivierung des Eingangstürschlosses und der zweiten Elektroverriegelung (Zufahrt) nur im Anschluss an einen Anruf oder eine Selbsteinschaltung;
- Funktion der Audio-/Video-Selbsteinschaltung auf dem Tastenfeld;
- Intercom-Anruf zwischen einzelnen Videosprechanlagen im Inneren derselben Wohnung;
- Gruppen-Intercom-Anruf an alle zu derselben Wohnung gehörenden Videosprechanlagen;
- Gruppen-Intercom-Anruf zwischen Videosprechanlagen unterschiedlicher Wohnungen (Funktion nur verfügbar mit Kit Typ 1723/96).













### **Zusatzfunktionen**













- Möglichkeit des Anschließens von bis zu 4 Überwachungskameras in der Anlage mit Hilfe einer speziellen Vorrichtung;
- Funktion der zyklischen automatischen Selbsteinschaltung von jeder beliebigen Videosprechanlage aus, auf den Rufeinheiten, auf der jeweiligen lokalen Kamera und auf den Überwachungskameras in der Anlage;
- Auf der "Master"-Videosprechanlage ist Folgendes möglich:
  - Die Funktion der Rufumleitung eines Audio-Video- oder eines reinen Audioanrufs an ein Smartphone oder Tablet mit Betriebssystem Android bzw. iOS aktivieren;
  - Aktivieren eines Aufzeichnungsgeräts der Videosprechanlage, das in der Lage ist, bis zu 32 Videonachrichten zu jeweils 10 s aufzuzeichnen;
  - Versenden einer zuvor aufgezeichneten Audionachricht an den Anrufer (Dauer max. 20 s);



- Aktivieren einer reinen synchronen Videoaufzeichnung mit dem Anruf (bis zu 32 Aufzeichnungen zu jeweils 20s);
- Möglichkeit des Aufzeichnens kurzer Audionachrichten (POST-IT) auf jeder beliebigen Videosprechanlage des Systems (max. 32 Nachrichten zu jeweils 20 s);
- Möglichkeit der automatischen Aktivierung der Elektroverriegelung des Eingangs im Anschluss an einen Anruf;
- Möglichkeit der Videoaufzeichnung und Speicherung auch auf Micro SD-Karte;
- Möglichkeit des Mikrofonausschlusses;
- Möglichkeit des Einblendens von Datum und Uhrzeit mit zusätzlicher Terminkalenderfunktion;
- Erfassen eines Alarms:
  - Anzeige mit Led und Aussenden eines akustischen Warntons auf der Videosprechanlage;
  - Wiederholung des akustischen Signals auf einer Sirene;
  - Aktivierung einer Kamera zum Aufnehmen der Bilder bei automatischem Aufzeichnen einer Videonachricht;
- Aktivierung der Yokis-Funkmodule von jeder beliebigen Videosprechanlage aus;
- Programmierung der Aktivierungen der Yokis-Funkmodule einmal oder mehrmals pro Woche;
- Ruf- und/oder Alarmumleitung auf Smartphone mit entsprechender Vorrichtung.
- Möglichkeit der Aktualisierung der Firmware des Systems über MicroSD-Karte.















## 2 ZUSAMMENSETZUNG DES KITS

Beschreibung		Nr.	ID	
Tastenfeld (A)	Tastenfeld Mod. MIKRA2 mit 1 Ruftaste (nur im Kit Typ 1723/95)	1		A1
	Tastenfeld Mod. MIKRA2 mit 2 Ruftasten (nur im Kit Typ 1723/96)	1		A2
	Schrauben für die Wandbefestigung (ø 3,5 x 32 mm)	4		A3
	Dübel für die Wandbefestigung(ø 5 mm)	4		A4
	Einsatz für Schraubenzieher (ø2 mm)	1		A5
	Graues Namensschild (1 im Kit Typ 1723/95, 2 im Kit Typ 1723/96)	1/2		A6
	Durchsichtiges Namensschild (1 im Kit Typ 1723/95, 2 im Kit Typ 1723/96)	1/2		A7
	Reserve-Inbusschraube zum Schließen des Tastenfelds (M3 x 12 mm)	1		A8
	Master-Schlüssel MIFARE zur Programmierung	1		A9
	Berührungslose Schlüssel MIFARE (5 im Kit Typ 1723/95, 10 im Kit Typ 1723/96)	5/10		A10
	Chip tag (2 im Kit Typ 1723/95, 4 im Kit Typ 1723/96)	2/4		A11
	Ferritabschirmung für Chip tag (2 im Kit Typ 1723/95, 4 im Kit Typ 1723/96)	2/4		A12
Bedienungsanleitung für Chip tag (1 im Kit Typ 1723/95, 2 im Kit Typ 1723/96)	1/2		A13	

Wohnungseinheit (B)	Videosprechanlage Mod. VMODO "Master" (1 im Kit Typ 1723/95, 2 im Kit Typ 1723/96)	1/2		B1
	Halterung für die Wandbefestigung (1 im Kit Typ 1723/95, 2 im Kit Typ 1723/96)	1/2		B2
	Schrauben für die Wandbefestigung (ø 2,0 x 32 mm) (4 im Kit Typ 1723/95, 8 im Kit Typ 1723/96)	4/8		B3
	Dübel für die Wandbefestigung (ø 5mm) (4 im Kit Typ 1723/95, 8 im Kit Typ 1723/96)	4/8		B4
	Schrauben zur Befestigung auf Einbaugehäuse Mod.503 (M 3,5 x 19 mm) (2 im Kit Typ 1723/95, 4 im Kit Typ 1723/96)	2/4		B5
	Hebel zum Entfernen der Frontplatte der Videosprechanlage (1 im Kit Typ 1723/95, 2 im Kit Typ 1723/96)	1		B6
	6-Wege-Kabel für den Anschluss von Geräteoptionen (1 im Kit Typ 1723/95, 2 im Kit Typ 1723/96)	1/2		B7
	Ausziehbare Klemmenleisten zum Anschluss der Videosprechanlage an das System (2 im Kit Typ 1723/95, 4 im Kit Typ 1723/96)	2/4		B8
	2-Wege-Kabel für den Anschluss einer Temperaturfühleroption (1 im Kit Typ 1723/95, 2 im Kit Typ 1723/96)	1/2		B9
	Netzteil (C)	Systemnetzteil	1	
Audio-Video-Induktanz		1		C2
(D)	Video-Verteiler (nur im Kit Typ 1723/96)	1		D

### 3 ZUSÄTZLICHE VORRICHTUNGEN

Beschreibung		Max. Anzahl (Bei eventueller Maximalkonfiguration der Anlage)	ID	
Elektroverriegelung (12 V~, max. 15 VA)	-	2 (eine pro Tastenfeld)		OP1
Taste zur Betätigung der Elektroverriegelung des Eingangs	-	2 (eine pro Tastenfeld)		OP2
Relaiskontakte zur Aktivierung des Türöffners der Zufahrt (max. umschaltbarer Strom 1A @ 30V)	-	2 (einer pro Tastenfeld)		OP3
Tür offen-Sensor	Karte 1033/701	2 (einer pro Tastenfeld)		OP4 (*)
Funkläutwerk (nur auf dem französischen Markt erhältlich)	Cod. 43410	12 (3 für jede Videosprechanlage)		OP5 (**)
Zusätzliches Läutwerk (max. 4 mit Kit Typ 1723/95, max. 8 mit Kit Typ 1723/96)	Karte 9854/43	4/8 (eines für jede Videosprechanlage)		OP5A (**)
Zusätzliche Videosprechanlagen "Slave" Mod. VMOD0 7" Freisprechfunktion (max. 3 mit Kit Typ 1723/95, max. 6 mit Kit Typ 1723/96)	Karte 1723/97	3/6		OP6
Magnetischer Alarmsensor	Karte 1033/701	2 (einer auf jeder Master- Videosprechanlage)		OP7
Anwesenheitssensoren (NC bei Abwesenheit von Meldungen)	Karte 1033/012 Karte 1033/132	4 (zwei auf jeder Master- Videosprechanlage)		OP7a (#)
Taste für den Anruf auf der Etage	-	2 (eine auf jeder Master- Videosprechanlage)		OP8
Sekundäres Tastenfeld für Einfamilienhäuser Mod. MIKRA2	Karte 1723/11	1		OP9
Sekundäres Tastenfeld für Zweifamilienhäuser Mod. MIKRA2	Karte 1723/12	1		OP10
Tastatur für die Zugangskontrolle	Karte 1723/46	2 (eine pro Tastenfeld)		OP11
Einbau-Kit für Tastenfeld	Karte 1723/50	2 (eine pro Tastenfeld)		OP12
Relaisgehäuse für 2 Tastenfelder	Karte 1723/51	1		OP13
Tischhalterung für Videosprechanlage 7" mit Freisprechfunktion (max. 4 s mit Kit Typ 1723/95, max. 8 s mit Kit Typ 1723/96)	Karte 1723/52	4/8		OP14
Einbau-Kitt für Videosprechanlage 7" mit Freisprechfunktion (max. 4 s mit Kit Typ 1723/95, max. 8 s mit Kit Typ 1723/96)	Karte 1723/60	4/8		OP16

Überwachungskameraschnittstelle	Karte 1723/69	1		
Passive Videovorrichtung BALUN mit 1 Kanal	Karte 1092/300A	4 (eine für jede an die Überwachungskameraschnittstelle angeschlossene Kamera)		OP17
Kit Mifare-Schlüssel	Karte 1723/102	maximal 21 Schlüssel in der Anlage		OP18
Kompaktkamera AHD DAY & NIGHT mit fester Optik 3,6 mm (max. 4 s mit Kit Typ 1723/95, max. 8 s mit Kit Typ 1723/96)	Karte 1092/250A	4/8 (eine pro Videosprechanlage)		OP19 (#)
Passive Videovorrichtung BALUN mit 1 Kanal	Karte 1092/300A	4/8 (eine für jede Kamera Typ 1092/250A)		
Programmierbarer Ausgang, der wie folgt aktiviert werden kann: - im Anschluss an das Betätigen der Home Automation-Taste (Treppenlichtfunktion als Standard), - im Anschluss an ein Alarmereignis, - über die Thermostatfunktion.	-	-		OP20 (**)
Zeitschaltbares Relais 2000W	Cod. 5454462	eines pro Kit		
Relais mit Spule bei 230V~	Cod. 5454081	eines pro Kit		
2-Kanal-Sender für Tasten Mod. E2BPP	Cod. 5454413	1 (nur für Kit Typ 1723/95)		OP21 (*)
4-Kanal-Sender für Tasten Mod. E4BPP	Cod. 5454427	2 (nur für Kit Typ 1723/96)		
Magnetischer Alarmsensor (2 mit Kit Typ 1723/95, 4 mit Kit Typ 1723/96)	Karte 1033/701	2/4		
Temperaturfühler Yokis THERMPROBE (max. 4 s mit Kit Typ 1723/95, max. 8 s mit Kit Typ 1723/96)	Karte 5454488	4/8 (einer für jede Videosprechanlage)		OP22
Netzteil für Kamera Typ 1092/250A	Karte 1092/800	4 (eines für jede Kamera im Fall des Einsatzes der Überwachungskameraschnittstelle Typ 1723/69)		OP23
Lokaler Transformator für 1723/97 (2 mit Kit Typ 1723/95, 6 mit Kit Typ 1723/96)	Karte 1723/22	2/6 (einer für jede Slave-Videosprechanlage)		C4
Video-Verteiler (nur vorhanden im Kit Typ 1723/96)	Karte 1723/55	1		D

(\*) Die beiden Optionen schließen sich gegenseitig aus.

(\*\*) Wegen weiterer Einzelheiten siehe Absatz 7.5 - RELAISFUNKTIONEN UND KONFIGURATIONEN

(#) Die beiden Optionen schließen sich gegenseitig aus.

## 4 ERSATZTEILE

Beschreibung		ID	Beschreibung		ID	
Systemnetzteil	BN 1723/20	 C1	"Master"-Videoanlage 7" mit Freisprecheinrichtung Mod. VMODO	BN 1723/98	 B1	
Audio-Video-Induktanz	BN 1723/112	 C2	Tastenfeld Mod. MIKRA2 mit 1 Ruftaste (nur im Kit BN 1723/95)	BN 1723/11	 A1	
Video-Verteiler	BN 1723/55	 D	Tastenfeld Mod. MIKRA2 mit 2 Ruftasten (nur im Kit BN 1723/96)	BN 1723/12	 A2	

## 5 BLOCK-ANSCHLUSSDIAGRAMME

### 5.1 EINFAMILIENHAUSANLAGE

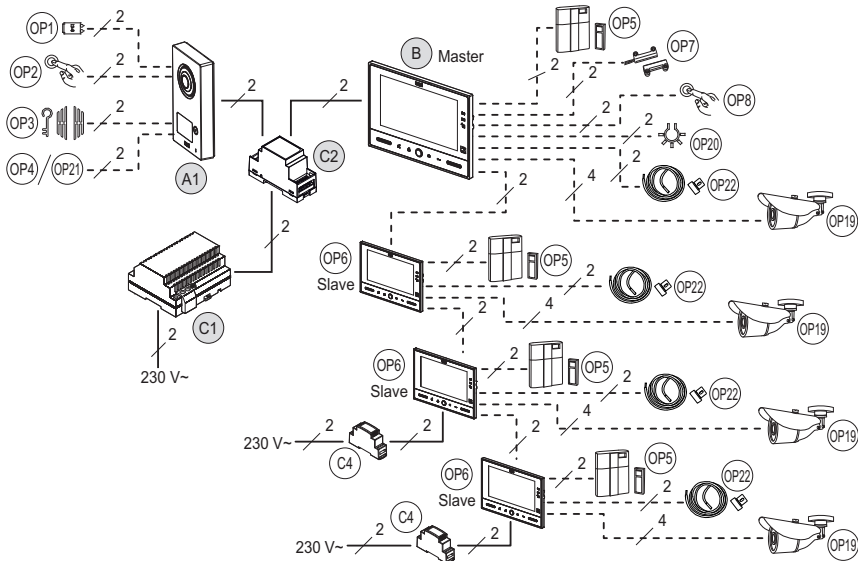

#### 5.1.1 Maximale Abstände zwischen den Geräten

Abschnitt	Kabeltyp					
	SYT1-3P-AWG20 (Ø 0,8 mm)	Telefonschleife Ø 0,6 mm ohne Ummantelung	CAT5	1,5 mm <sup>2</sup> Einzelkabel	2Voice	PTT278
A1 – C2	150 m	150 m	100 m	75 m	200 m	100 m
C1 – C2	0,5 m	0,5 m	0,5 m	0,5 m	0,5 m	0,5 m
C2 – am weitesten entfernte Videosprechanlage (OP6)	50 m	50 m	50 m	20 m	50 m	50 m
A – OP1	10 m	10 m	10 m	20 m	20 m	10 m
A – OP2	50 m	50 m	30 m	50 m	50 m	50 m
A – OP3	10 m	10 m	10 m	20 m	20 m	10 m
A – OP4	25 m	25 m	25 m	25 m	25 m	25 m
A – OP21	10 m	10 m	10 m	10 m	10 m	10 m
B – OP5	30 m	30 m	30 m	30 m	30 m	30 m
B – OP7	30 m	30 m	30 m	30 m	30 m	30 m
B – OP8	30 m	30 m	30 m	30 m	30 m	30 m
B – OP19	-	-	50 m	-	-	-
B – OP20	30 m	30 m	30 m	30 m	30 m	30 m
OP6 – C4	20 m	10 m	10 m	30 m	20 m	20 m
OP6 – OP5	30 m	30 m	30 m	30 m	30 m	30 m

⚡ Die verwendeten Kabel müssen bei einem Querschnitt von 0,5 mm<sup>2</sup> oder mehr der Norm IEC 60332-1-2 entsprechen bzw. der Norm IEC 60332-2-2 bei einem Querschnitt von unter 0,5 mm<sup>2</sup>.

## 5.2 ZWEIFAMILIENHAUSANLAGE

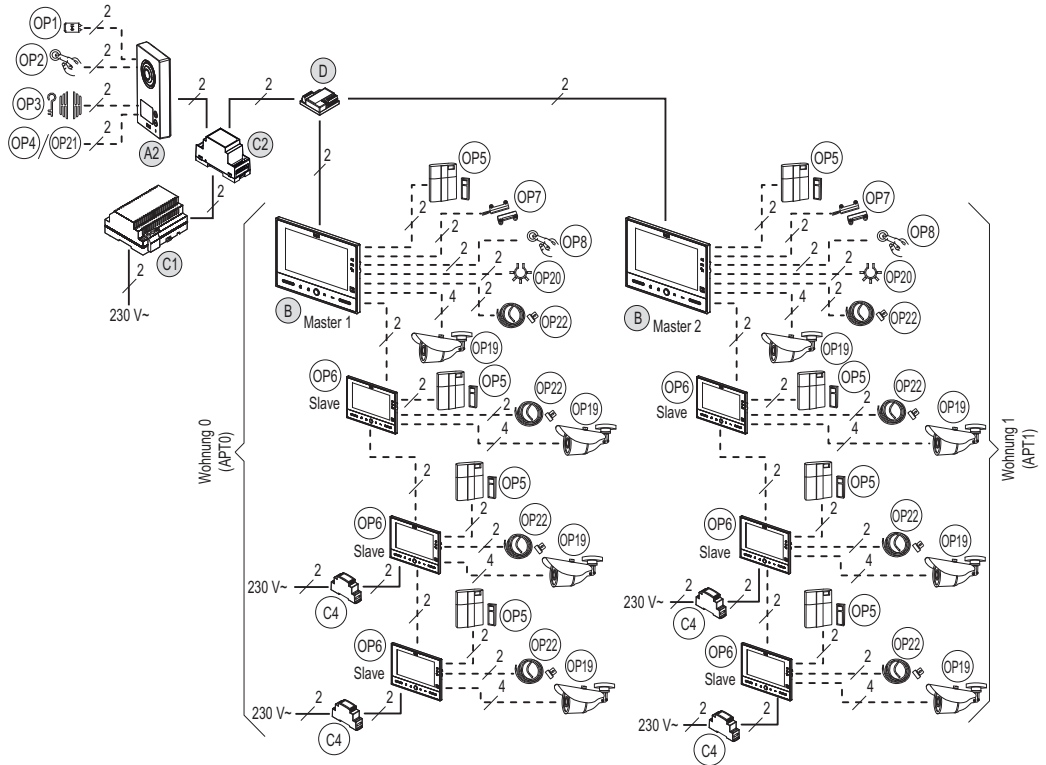

### 5.2.1 Maximale Abstände zwischen den Geräten

Abschnitt	Kabeltyp					
	SYT1-3P-AWG20 (Ø 0,8 mm)	Telefonschleife Ø 0,6 mm ohne Ummantelung	CAT5	1,5 mm <sup>2</sup> Einzelkabel	2Voice	PTT278
A2 – C2	150 m	150 m	100 m	75 m	200 m	100 m
C1 – C2	0,5 m	0,5 m	0,5 m	0,5 m	0,5 m	0,5 m
C2 – D	5 m	5 m	5 m	5 m	5 m	5 m
C2 – am weitesten entfernte Videosprechanlage (OP6)	50 m	50 m	50 m	20 m	50 m	50 m
A – OP1	10 m	10 m	10 m	20 m	20 m	10 m
A – OP2	50 m	50 m	30 m	50 m	50 m	50 m
A – OP3	10 m	10 m	10 m	20 m	20 m	10 m
A – OP4	25 m	25 m	25 m	25 m	25 m	25 m
A – OP21	10 m	10 m	10 m	10 m	10 m	10 m
B – OP5	30 m	30 m	30 m	30 m	30 m	30 m
B – OP7	30 m	30 m	30 m	30 m	30 m	30 m
B – OP8	30 m	30 m	30 m	30 m	30 m	30 m
B – OP19	-	-	50 m	-	-	-
B – OP20	30 m	30 m	30 m	30 m	30 m	30 m
OP6 – C4	20 m	10 m	10 m	30 m	20 m	20 m
OP6 – OP5	30 m	30 m	30 m	30 m	30 m	30 m

⚡ Die verwendeten Kabel müssen bei einem Querschnitt von 0,5 mm<sup>2</sup> oder mehr der Norm IEC 60332-1-2 entsprechen bzw. der Norm IEC 60332-2-2 bei einem Querschnitt von unter 0,5 mm<sup>2</sup>.

## 6 WICHTIGE HINWEISE FÜR DEN INSTALLATEUR

---

Von folgenden Anweisungen ist aufmerksam Notiz zu nehmen, da sie wichtige Hinweise für die Sicherheit, den Gebrauch und die Wartung der Anlage geben.

- Diese Geräte, die Teil des Kits sind, dürfen nur für ihren ausdrücklich vorgegebenen Bestimmungszweck eingesetzt werden. Jedweder anderweitige Gebrauch ist unvorhergesehen und deshalb gefährlich. Der Hersteller übernimmt keinerlei Verantwortung für Schäden, die durch unsachgemäßen oder falschen Gebrauch entstehen.
- Jeder Teil wurde so ausgelegt, dass es den geltenden Normen entspricht.
- Die Ausführung der Anlage muss den geltenden Normen entsprechen. Sämtliche Geräte der Anlage dürfen ausschließlich für den für sie vorgesehenen Gebrauch verwendet werden.
- Nach dem Entfernen der Verpackung der verschiedenen Bauteile ihre Unversehrtheit sicherstellen.
- Die Verpackungselemente (Plastiktüten, Polystyrol, etc.) dürfen nicht in Reichweite von Kindern gelassen werden, da sie eine potentielle Gefahrenquelle darstellen.
- Vorgesaltet für die Geräte einen geeigneten Trenn- und Schutzschalter mit Abstand der Öffnung der Kontakte von mindestens 3 mm vorsehen.
- Bevor das Gerät an das Versorgungsnetz angeschlossen wird, ist sicherzustellen, dass die Kenndaten denen des Verteilernetzes entsprechen.
- Öffnungen und Schlitze für die Belüftung und Hitzeabsonderung sind freizuhalten.
- Vor sämtlichen Reinigungs- und Instandhaltungsarbeiten müssen die Geräte über den Hauptschalter der Anlage vom elektrischen Versorgungsnetz getrennt werden.
- Kein Spray für die Reinigung verwenden.
- Bei Störungen und/oder Fehlfunktionen der im Kit enthaltenen Produkte ist die Stromzufuhr über den Hauptschalter zu unterbrechen, ohne diesen zu beschädigen.
- Für eventuell notwendige Reparaturen ist nur ein vom Hersteller befugter technischer Kundendienst heranzuziehen.
- Eine angemessene Belüftung ist vorzusehen.
- Für das Kabel des Versorgungsnetzes dürfen keine Verlängerungskabel verwendet werden.
- Sollten Gegenstände oder Flüssigkeit in das Netzgerät eindringen, ist die Überprüfung, bzw. die evtl. notwendige Reparatur, durch einen Fachmann vorzunehmen.
- Für die Reparaturen sind ausschließlich vom Hersteller gelieferte Originalersatzteile zu verwenden.
- Der Installateur muss sicherstellen, dass die Benutzerinformationen an den Nebenanschlüssen ausliegen.
- Bei Nichtbeachtung der o.g. Angaben kann die Sicherheit der Installation beeinträchtigt werden.
- Dieses Dokument muss dem Gerät grundsätzlich beiliegen.
- Das Blitzzeichen mit Pfeil in einem gleichseitigen Dreieck, zeigt dass gefährliche Spannungen vorhanden sind.



- Die Geräte nicht öffnen, wenn dies in der vorliegenden Bedienungsanleitung nicht ausdrücklich vorgesehen ist.
- Das Ausrufzeichen in einem gleichseitigen Dreieck, zeigt sicherheitskritische Bauteile an, daher sollten nur Originalbauteile vom Hersteller verwendet werden.



# 7 INSTALLATION DER VIDEOSPRECHANLAGE

## 7.1 BESCHREIBUNG DER BESTANDTEILE

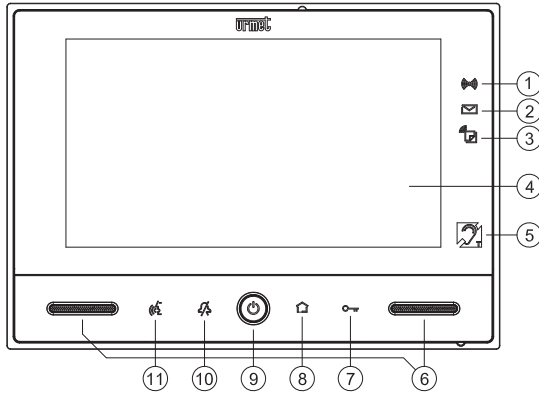

### Frontal:

1. Alarmsymbol
2. Symbol der Anzeige von Post im Briefkasten (LETTERBOX-Funktion)
3. Symbol zur Anzeige des aktiven Anrufbeantworters (durchgehend grün) / Vorliegens von POST-IT-Audionachrichten (rot blinkend) / der aktiven Rufumleitungsfunktion (durchgehend gelb) (nur auf Master-Videosprechanlage BN 1723/98).
4. 7"-Display
5. Symbol, das angibt, dass die Videosprechanlage mit der Gesprächsverstärkungsrichtung für Hörbehinderte (ILA) ausgestattet ist
6. Lautsprecher
7. Taste (Touch) Türöffner
8. Empfangsbestätigungssymbol Yokis-Befehl
9. ON/OFF-Einschalttaste
10. Taste (Touch) "MUTE"
11. Taste (Touch) Gesprächsaktivierung

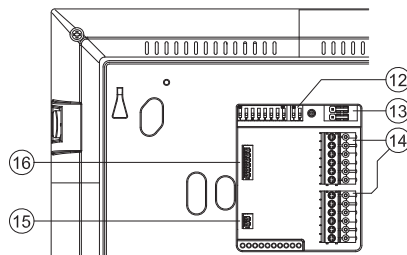

### Rückseitiger Teil:

12. Konfigurations-Dip-Switch
13. Polbrücken
14. Ausziehbare 6-Wege-Klemmleisten
15. 2-Wege-Verbinder für externen Thermostat
16. 6-Wege-Verbinder für den Anschluss der externen Kamera / Relais 2 (OP20)



## 7.2 INSTALLATION

- Die Anbauhalterung mit einer Einbaudose 503 und den beiliegenden Schrauben oder einer Runddose  $\varnothing$  60 mm und entsprechenden Schrauben an der Wand befestigen.
- Die Dip-Switches programmieren und die Leiter der Anlage an die Klemmenleisten anschließen.
- Die Videosprechanlage an der Anbauhalterung auf den 4 Haken an den Seiten befestigen.
- Die Schutzfolie vom Display entfernen.

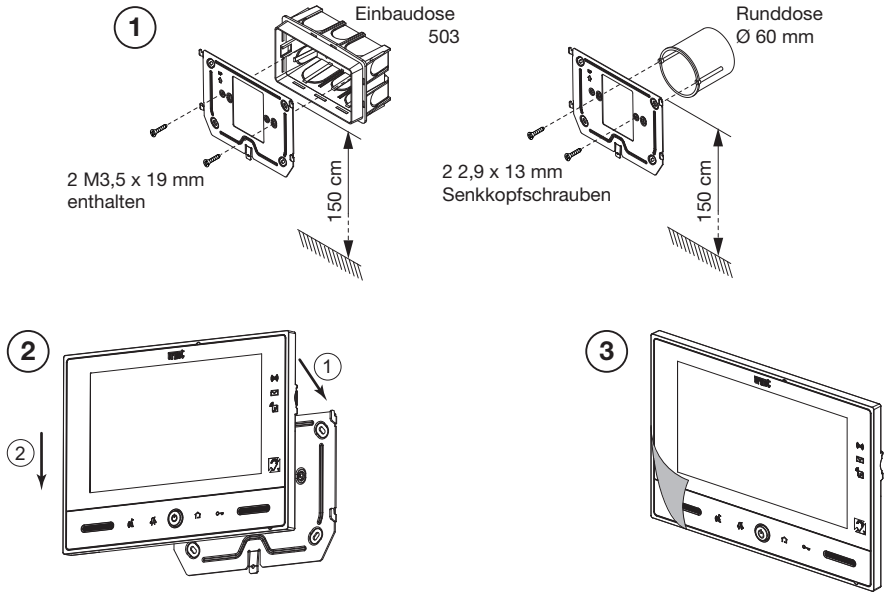

Die Schutzfolie vom Display der Videosprechanlage entfernen.

## 7.3 BESCHREIBUNG DER KLEMMENLEISTEN

Klemmenleiste	Klemmenname	Beschreibung
1	LI	Bus-Eingang (LINE IN)
	LI	
	LO	Bus-Ausgang (LINE OUT)
	LO	
	LP	24 V~ lokale Versorgung
	LP	
2	FC	Etagenruf
	FC	
	0	Zusätzliches Läutwerk (Ausgang Relais 1 – OP5 / OP5A)
	C	
	AL	Alarmsensoreingang
	AL	

## 7.4 BESCHREIBUNG DES VERBINDERS FÜR DIE EXTERNE KAMERA / RELAIS 2 (OP20)

An die "Master"-Videosprechanlage kann die externe Kamera Typ 1092/250A mit dem im Lieferumfang enthaltenen Kabel (B7) angeschlossen werden.

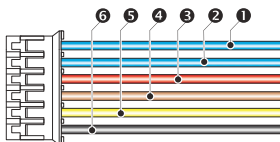

Draht-Nr.	Drahtfarbe	Beschreibung	Name des Pins auf dem Verbinder
1	Blau	Treppenlicht (Ausgang Relais 2 – OP20)	RELAY SPARE
2	Blau	Treppenlicht (Ausgang Relais 2 – OP20)	RELAY SPARE
3	Rot	Positiver Pol Versorgung Kamera	CCTV POWER+
4	Braun	Minuspol des Signals im Ausgang aus dem Video Balun	CCTV VIDEO-
5	Gelb	Pluspol des Signals im Ausgang aus dem Video Balun	CCTV VIDEO+
6	Schwarz	Negativer Pol Versorgung Kamera	CCTV POWER-

## 7.5 RELAISFUNKTIONEN UND KONFIGURATIONEN

Die Videosprechanlage ist mit zwei programmierbaren Relais ausgestattet, wie in der Tabelle im Anschluss angegeben:

Relais	Mögliche Funktion	Standard	Bezug
1	Zusätzliches Lätwerk	✓	OP5 / OP5A
	Taste Home Automation 1		
	Alarm Sirene		
2	Taste Home Automation 2	✓	OP20
	Alarm Sirene		
	Thermostatausgang		

## 7.6 POLBRÜCKENKONFIGURATION (JP1 und JP2)

Auf der Videosprechanlage sind zwei Polbrücken vorhanden:

- JP1: gestattet das Einfügen des Leitungsendes. Auf der am Ende einer Leitung, die nicht mit einem neuen Abschnitt von den LINE OUT-Klemmen aus weitergeht, angeschlossenen Videosprechanlage muss das Leitungsende aktiviert werden.

	JP1
Eingefügtes Leitungsende (Standard)	
Nicht eingefügtes Leitungsende	

- JP2: gestattet die Versorgung der Videoanlage über die Bus-Leitung bzw. über einen lokalen Transformator Typ 1723/22.



	JP2
Versorgung über die Bus-Leitung (Standard)	
Versorgung über lokalen Transformator	

## 7.7 DIP-SWITCH-KONFIGURATION

Auf der Videosprechanlage sind 8 Dip-Switches auf der Geräterückseite positioniert.





⚡ Die Dip-Switches 5, 7 und 8 werden nicht verwendet.

### 7.7.1 Ruftastenzuordnung auf der Videosprechanlage

	Position Dip-Switch 1		Position Dip-Switch 1
Der Ruftaste <b>0</b> zugeordnete Videosprechanlage (oben)		Der Ruftaste <b>1</b> zugeordnete Videosprechanlage (unten)	

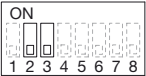
### 7.7.2 Code der Videoanlage

Sollte die Absicht bestehen, "Slave"-Videosprechanlagen zu installieren, muss auf jeder Innenstelle der jeweilige Code mittels Dip-Switch 2 und 3 eingegeben werden.



Videosprechanlagentyp	Position Dip-Switch 2 und 3	Videosprechanlagentyp	Position Dip-Switch 2 und 3
"Master"-Videosprechanlage		"Slave"-Videosprechanlage Nr. 1	
"Slave"-Videosprechanlage Nr. 2		"Slave"-Videosprechanlage Nr. 3	



### 7.7.3 Anlagentyp

	Position Dip-Switch 4		Position Dip-Switch 4
Einfamilienhausanlage		Zweifamilienhausanlage	



### 7.7.4 Aktivierung des Gesprächs durch Betätigen der Taste ("Push to talk"-Modus)

Erweist sich die Kommunikation zwischen Tastenfeld und Videosprechanlage als gestört oder nicht vorhanden, sicherstellen, dass die durchsichtige Folie vom Display der Videosprechanlage entfernt wurde. Sollte die Folie entfernt worden sein und es treten weiter Audiostörungen auf, können die beiden Gesprächskanäle (nach innen und nach außen) einzeln aktiviert werden.

Nach dem Eingang eines Anrufs kurz  betätigen, um das Gespräch über das Tastenfeld zu aktivieren und im Anschluss wird durch Gedrückt halten der Taste  der Audiokanal nach außen aktiviert und man kann mit dem Anrufer sprechen. Zum Hören die Taste  loslassen.

	Position Dip-Switch 6		Position Dip-Switch 6
Funktion deaktiviert		Funktion aktiviert	

### 7.7.5 Werkseitige Einstellungen:

<b>Kit für Einfamilienhäuser Typ 1723/95:</b>	Video-Türtelefon	
<b>Kit für Zweifamilienhäuser Typ 1723/96:</b>	Videosprechanlage 1	
	Videosprechanlage 2	

## 8 INSTALLATION DES SYSTEMNETZTEILS UND DER AUDIO-VIDEO-INDUKTANZ

Das Netzteil muss im Inneren der Schalttafel oder in einem Schaltschrank installiert werden.

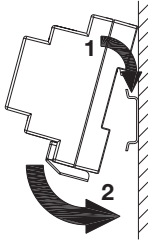

Installation auf DIN-Schiene (6 Module mit 18 mm)

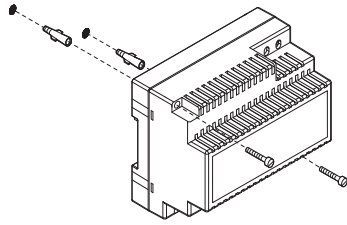

Aufputz-Installation

Das Modul der Induktanz kann mit der im Lieferumfang enthaltenen Halterung oder auf der DIN-Schiene befestigt werden (2 Module zu 18 mm).

Das Modul der Induktanz muss in derselben Schalttafel wie das Netzteil installiert werden.

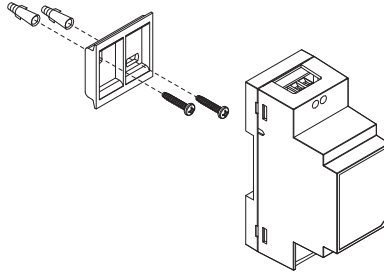

### 8.1.1 Beschreibung der Klemmen

#### Systemnetzteil Typ 1723/20

- |   |               |  |
|---|---------------|--|
| ⊘ | 110-230V~ / N | } Eingang Netzversorgungsspannung 110-230 V~ |
| ⊘ | +             |  |
| ⊘ | -             | } Ausgang Versorgungsspannung:               |

#### Audio-Video-Induktanz Typ 1723/112

- |   |         |                                |
|---|---------|--------------------------------|
| ⊘ | +       | } Eingang Versorgungsspannung: |
| ⊘ | -       |                                |
| ⊘ | ] LINE1 | BUS 1-Leitung                  |
| ⊘ |         |                                |
| ⊘ | ] LINE2 | BUS 2-Leitung                  |
| ⊘ |         |                                |

## 9 INSTALLATION DES TASTENFELDS

### 9.1 BESCHREIBUNG DER BESTANDTEILE

Tastenfeld Mod. MIKRA2 mit 1 Ruftaste

(nur vorhanden im Einfamilienhaus-Kit Typ 1723/95)

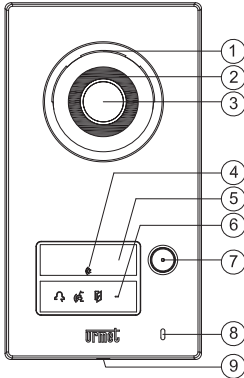

Tastenfeld Mod. MIKRA2 mit 2 Ruftasten

(nur vorhanden im Zweifamilienhaus-Kit Typ 1723/96)

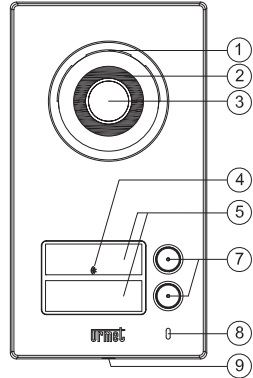

Frontal:

1. Lautsprecher
2. Kamerabeleuchtungs-Led
3. Kamera
4. Transponder-Lesegerät
5. Namensschild/er
6. Led-Anzeigen für die DDA-Funktion
7. Ruftaste/n
8. Mikrofon
9. Verschlusschraube für die Fronttafel

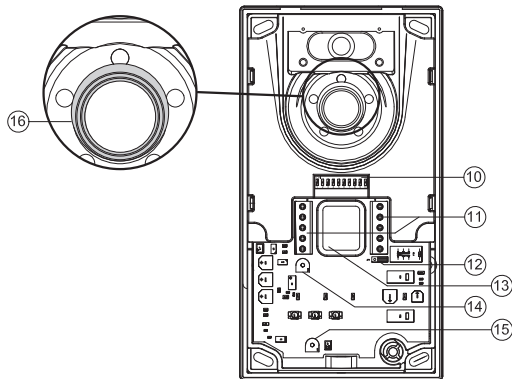

Interner Teil:

10. Konfigurations-Dip-Switch
11. Klemmenbrett
12. **Die Position dieser Polbrücke nicht verändern!**
13. Bohrung für die Kabeldurchführung
14. Trimmer zur Einstellung der Lautsprecherlautstärke
15. **Diesen Trimmer nicht drehen!**
16. Antireflex-Dichtung

## 9.2 INSTALLATION

- Das Tastenfeld auf der angegebenen Höhe installieren und überprüfen, ob die Person sich im Erfassungsfeld der Kamera befindet
- Die Drähte an die Klemmenleisten anschließen
- Die Namensschilder auf der Fronttafel montieren
- Die Programmierungen durchführen
- Wenn erforderlich die Lautstärke des Lautsprechers einstellen
- Das Tastenfeld mit der Metallabdeckung verschließen
- Die Schutzfolien entfernen

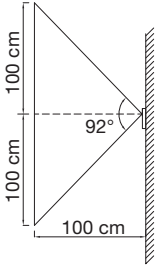

Vertikales  
Aufnahmefeld

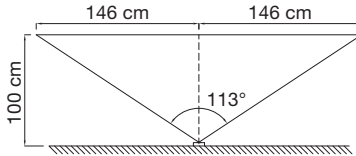

Horizontale  
Aufnahmefeld

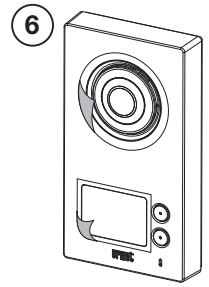
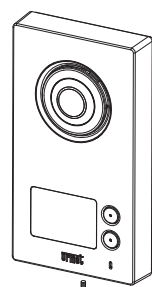
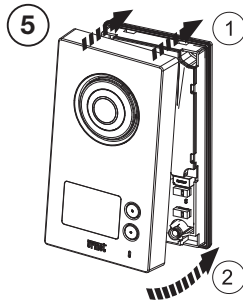
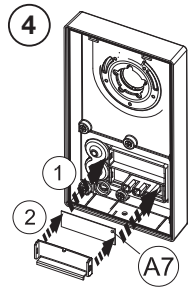
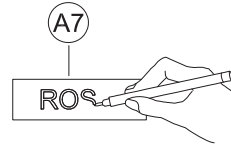
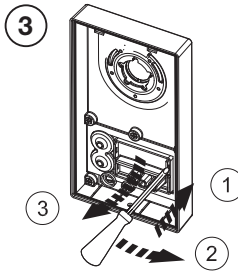
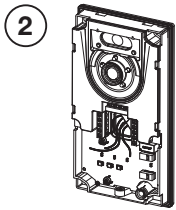
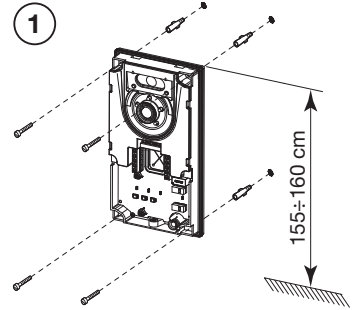

### 9.3 ANSCHLUSSKLEMMEN

#### Linke Klemmenleiste

- ⊘ SE- Minuspol Betätigung Elektroverriegelung mit kapazitiver Entladung
- ⊘ SE+ Pluspol Betätigung Elektroverriegelung mit kapazitiver Entladung
- ⊘ } PA Eingang für Taste Elektroverriegelung des Eingangs
- ⊘ SP Eingang des Sensors für die Funktion TÜRSTATUS bzw. LETTERBOX

#### Rechte Klemmenleiste



- ⊘ SP Eingang des Sensors für die Funktion TÜRSTATUS bzw. LETTERBOX
- ⊘ } LINE Busleitung
- ⊘ } N.O. Betätigung spannungsfreier Türöffnerkontakt (OP3)

### 9.4 DIP-SWITCH-KONFIGURATION



Auf dem Tastenfeld sind 10 Dip-Switches im Geräteinneren positioniert.

⚡ **Die Dip-Switches 6, 9 und 10 dürfen nicht verändert werden.**



#### 9.4.1 Auswahl der Funktion TÜRSTATUS bzw. LETTERBOX (Anzeige von Post im Briefkasten)

	Position Dip-Switch 1		Position Dip-Switch 1
Funktion TÜRSTATUS aktiviert		Funktion LETTERBOX aktiviert	



#### 9.4.2 Identifizierungs-Nr. des Tastenfelds

	Position Dip-Switch 2		Position Dip-Switch 2
Tastenfeld 1		Tastenfeld 2	



#### 9.4.3 Einschalten der Leds der Kamera während des Anrufs

	Position Dip-Switch 3		Position Dip-Switch 3
Funktion aktiviert		Funktion deaktiviert	

#### 9.4.4 Aktivierung für den Anruf der Wohnung 0 von Seiten beider auf dem Tastenfeld vorhandenen Tasten (Funktion nur verfügbar mit Zweifamilienhaus-Kit Typ 1723/96)

	Position Dip-Switch 4		Position Dip-Switch 4
Funktion deaktiviert		Funktion aktiviert	



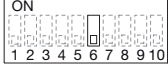

#### 9.4.5 Auswahl der Art der Aktivierung Elektroverriegelung des Eingangs und der Zufahrt, entweder mit kapazitiver Entladung oder mit Relais mit spannungsfreien Kontakten

	Position Dip-Switch 5		Position Dip-Switch 5
Aktivierung der Elektroverriegelung des Eingangs mit kapazitiver Entladung mit Impuls und Haltestrom (Klemmen SE+ und SE-); Aktivierung der Zufahrt mit Relais mit spannungsfreien Kontakten (N.O.-Klemmen).		Aktivierung der Elektroverriegelung des Eingangs mit Relais mit spannungsfreien Kontakten (N.O.-Klemmen); Aktivierung der Zufahrt mit kapazitiver Entladung mit Impuls und Haltestrom (Klemmen SE+ und SE-).	

### 9.4.6 Einstellung des Tastenfeldtyps

	Position Dip-Switch 6		Position Dip-Switch 6
Tastenfeld für Einfamilienhäuser		Tastenfeld für Zweifamilienhäuser	

### 9.4.7 Einstellung der Aktivierungsdauer der Elektroverriegelung mit kapazitiver Entladung

	Position Dip-Switch 7-8		Position Dip-Switch 7-8
0 Sekunden (Impuls von 300 ms)		3 Sekunden	
6 Sekunden		9 Sekunden	

### 9.4.8 Werkseitige Einstellungen

<b>Kit für Einfamilienhäuser Typ 1723/95:</b>	Tastenfeld 1	
<b>Kit für Zweifamilienhäuser Typ 1723/96:</b>	Tastenfeld 2	

## 9.5 EINSTELLUNG DER LAUTSPRECHERLAUTSTÄRKE

Die Lautstärkepegel werden vom Hersteller so voreingestellt, dass sie in den meisten Installationen nicht mehr geändert werden müssen.

Ist die Änderung der Tonhöhe dennoch erforderlich, muss die Regelung der Lautsprecherlautstärke mit einem Schraubendreher betätigt werden (siehe Punkt 14 von Absatz 9.1 - BESCHREIBUNG DER BESTANDTEILE).

## 10 TECHNISCHE EIGENSCHAFTEN

### Systemnetzteil

Netzteil in KAT III 4000 V

Versorgungsspannung: ..... **110-230 V~ 50-60 Hz**  
 Leistung: ..... **max. 75 W**  
 Sekundärausgang: ..... **50 V --- 1 A**  
 Leistungsaufnahme nach 1 Betriebsstunde: ..... **Max. 5 Wh (18 kJ)**  
 Abmessungen (LxBxT): ..... **108 (6 DIN-Module) x 90 x 61 mm**

### Audio-Video-Induktanz

Abmessungen (LxBxT): ..... **36 (2 DIN-Module) x 95 x 57 mm**

### Video-Türtelefon

Versorgungsspannung: ..... **über BUS 37÷48 V ---**  
**Über lokalen Transformator 24 V~ (+-10%)**

Aufnahme: maximal..... **280 mA @ 48 V ---**  
 In Ruhestellung (Basiskonfiguration) ..... **25 mA @ 48 V ---**

Bei Betrieb aufgenommene Leistung: ..... **max. 16 W**

Flüssigkristall-Display: ..... **7"-Bildschirm mit Hintergrundbeleuchtung**

Auflösung: ..... **1024H x 600V Pixel**

Sichtwinkel ..... **>±80°**

Einschaltverzögerung: ..... **Max. 2 s**

Sendekapsel: ..... **Elektretmikrofon**

Empfängerkapsel: ..... **Lautsprecher 45 Ω**

Unterstützung für externen Speicher: ..... **MicroSD Standard (empfohlen 2 GB)**

Funkreichweite:   
 • im Inneren einer Wohnung von 100 m<sup>2</sup> bei senkrechter Überquerung einer tragenden Wand oder einer Decke;  
 • 250 m ohne Hindernisse.

*In beiden Fällen erfolgt eine Verringerung der Reichweite bei vorhandenen Metallelementen oder dem Überqueren von Mauern oder Trennwänden.*



Funkübertragung: Die Led des Senders schaltet sich nur dann ein, wenn die Übertragung erfolgreich war. Im Fall unzureichender Reichweite, gestattet das Hinzufügen eines Empfängers das Lösen des Problems. Beziehen Sie sich auf die Bedienungsanleitung der Yokis-Sender.





Frequenzband:  
 WiFi: ..... 2400 ÷ 2483,5 MHz  
 Yokis: ..... 2400 ÷ 2480 MHz  
 Mifare: ..... 13,56 MHz  
 Ausgangsleistung (max.):  
 WiFi: ..... 20 dBm  
 Yokis: ..... 10 dBm  
 Mifare: ..... -13 dBµA/m @ 10m  
 Ausgang Relais 1 (OP5 / OP5A) ..... 100 mA @ 24 V ---  
 Ausgang Relais 2 (OP20 - RELAY SPARE) ..... 25 mA @ 24 V ---  
 Betriebstemperatur: ..... -5 ÷ +45 °C  
 Max. Feuchtigkeit: ..... 95 % rF  
 Abmessungen (LxBxT): ..... 202 x 142 x 22 mm

### Tastenfeld

Versorgungsspannung: ..... 36÷48 V ---  
 Aufnahme: maximal..... 130 mA @ 48 V ---  
 In Ruhestellung ..... 20 mA @ 48 V ---  
 Bei Betrieb aufgenommene maximale Leistung: ..... max. 6,5 W  
 Abmessungen (LxBxT): ..... 100 x 180 x 28 mm  
 Abmessungen des Namensschild: ..... 48,5 x 15,5 mm  
 Namensschild- und Tastenbeleuchtung: ..... Weiße LEDs  
 Gehäuseschutzgrad: ..... IP45  
 Schutzgrad gegen mechanische Stöße: ..... IK07  
 Betriebstemperatur: ..... -10 ÷ +50° C  
 Max. Feuchtigkeit: ..... 95 % rF  
 Max. Strom spannungsfreier N.O.-Kontakt (OP3): ..... 1 A @ 30 V ---  
 Sendekapsel: ..... Elektretmikrofon  
 Empfängerkapsel: ..... Lautsprecher 16 Ω wasserfest

⚡ Die verwendeten Kabel müssen bei einem Querschnitt von 0,5 mm<sup>2</sup> oder mehr der Norm IEC 60332-1-2 entsprechen bzw. der Norm IEC 60332-2-2 bei einem Querschnitt von unter 0,5 mm<sup>2</sup>.

## 11 ZEICHENERKLÄRUNG SYMBOLE

Symbol	Erklärung
---	Gleichstrom-Spannungsversorgung:
~	Wechselstromversorgung
<b>note 2</b>	Markenzeichen des Videosprechanlagensystems
	Netzteil mit einer Doppelisolierung ausgestattet
	GEFAHR - Gefährliche Spannung vorhanden
	GEFAHR - Für die Sicherheit kritische Komponenten vorhanden
	Siehe Installationsanleitung des Geräts

## 12 VEREINFACHTE EU-KONFORMITÄTSERKLÄRUNG

Hiermit erklärt URMET S.p.A., dass die Funkanlagentypen  
**2-DRAHT-VIDEOSPRECHANLAGEN-KIT FÜR EIN- UND ZWEIFAMILIENHÄUSER MIT RUFUMLEITUNG**  
 (Typ 1723/95 und 1723/96) der Richtlinie 2014/53/EU entsprechen.

Der vollständige Text der EU-Konformitätserklärung ist unter der folgenden Internetadresse verfügbar:

[www.urmet.com](http://www.urmet.com)

**INHOUDSOPGAVE**

1	ALGEMENE BESCHRIJVING.....	103
2	SAMENSTELLING VAN DE KIT .....	105
3	EXTRA APPARATUUR.....	107
4	ONDERDELEN.....	109
5	BLOKKENBEDRADINGSSCHEMA'S.....	109
5.1	SYSTEEM VOOR EEN WONING .....	109
5.1.1	Maximum afstand tussen de apparaten.....	109
5.2	TWEEWONINGENSYSTEEM.....	109
5.2.1	Maximum afstand tussen de apparaten.....	110
6	AANWIJZINGEN VOOR DE INSTALLATEUR.....	110
7	INSTALLATIE VAN DE VIDEO-INTERCOM.....	111
7.1	BESCHRIJVING VAN DE COMPONENTEN .....	112
7.2	INSTALLATIE.....	112
7.3	BESCHRIJVING VAN DE KLEMMENBORDEN.....	113
7.4	BESCHRIJVING VAN DE CONNECTOR VOOR DE EXTERNE CAMERA / RELAIS .....	113
7.5	FUNCTIES EN RELAISCONFIGURATIES.....	114
7.6	CONFIGURATIE VAN DE OVERBRUGGINGEN (JP1 en JP2).....	114
7.7	CONFIGURATIE VAN DE DIP-SWITCHES .....	114
7.7.1	Toewijzing knop voor oproep aan video-intercom.....	114
7.7.2	Code van de video-intercom .....	115
7.7.3	Systeemtypen.....	115
7.7.4	Telefoon inschakelen met druk op toets (modus "Push to talk").....	115
7.7.5	Fabrieksinstellingen.....	115
8	INSTALLATIE VAN DE SYSTEEMVOEDING EN AUDIO VIDEO DE INDUCTIESPOEL .....	115
8.1.1	Beschrijving van de aansluitklemmen .....	116
9	INSTALLATIE VAN DE DEURPLAAT.....	116
9.1	BESCHRIJVING VAN DE COMPONENTEN .....	117
9.2	INSTALLATIE.....	117
9.3	BESCHRIJVING VAN DE KLEMMENBORDEN.....	118
9.4	CONFIGURATIE VAN DE DIP-SWITCHES .....	119
9.4.1	Selectie van de functie DEURSTATUS of LETTERBOX .....	119
9.4.2	Identificatienummer van de deurplaat.....	119
9.4.3	Inschakeling van de camera-leds tijdens de oproep.....	119
9.4.4	Inschakeling van de oproep van woning 0 met beide toetsen op de deurplaat .....	119
9.4.5	Selectie van het type inschakeling van het elektrisch voordeurslot en inrijpoortslot.....	119
	met thyristorontsteking of met relais met droge contacten .....	119
9.4.6	Instelling van het type deurplaat .....	120
9.4.7	Regeling van de inschakeltijd voor het elektrisch slot met thyristorontsteking.....	120
9.4.8	Fabrieksinstellingen.....	120
9.5	VOLUMEREGELING LUIDSPREKER.....	120
10	TECHNISCHE KENMERKEN .....	120
11	LEGENDE SYMBOLEN.....	121
12	VEREENVOUDIGDE EU-CONFORMITEITSVERKLARING .....	121
13	BEDRADINGSSCHEMA'S .....	122
13.1	AANSLUITING VAN DE KIT VOOR EEN WONING NR.1723/95 MET 3 PARALLEL GESCHAKELDE VIDEO-INTERCOMS .....	122
13.2	AANSLUITING VAN DE KIT VOOR TWEE WONINGEN SCH.1723/96 MET 3 PARALLEL TUSSEN ELKE VERBRUIKER GESCHAKELDE VIDEO-INTERCOMS.....	124
13.3	AANSLUITING VAN DE EXTRA BEL NAAR DE VIDEO-INTERCOM .....	126
13.3	LEGENDE SCHEMA'S.....	127
13.4	OPMERKINGEN OMTRENT DE SCHEMA'S.....	129

# 1 ALGEMENE BESCHRIJVING

---

Elke video-intercom-kit Mod. NOTE2 is gemakkelijk te installeren omdat er maar 2 niet gepolariseerde draden worden gebruikt voor de verbinding tussen de diverse apparaten.

Dankzij de modulariteit kunnen diverse extra functies worden toegevoegd aan de basisfuncties van het video-intercomsysteem om oplossingen te bieden voor elke behoefte.

De kenmerken van het video-intercomsysteem zijn de volgende:

## Systeem

- Kit voor één woning nr. 1723/95:
  - Gebruik van 2 video-intercoms zonder extra stroomvoorziening
  - Beheert tot 4 video-intercoms (1 “master” en 3 “slave”) met paralleloproepen en binnenkomen/buitengaan-verbinding
- Kit voor twee woningen nr. 1723/96:
  - Gebruik van 2 video-intercoms zonder extra stroomvoorziening, 1 per woning
  - Beheert tot 8 video-intercoms (2 “master” en 6 “slave”) met paralleloproepen, videoverdeler in de stijgleiding en binnenkomen-buitengaan-verbinding per verdieping;
- Alle apparaten worden aangesloten met slechts 2 niet gepolariseerde draden
- Aansluiting van de voeding op een willekeurig punt in het systeem tussen de belplaat en de video-intercom
- Beheert tot 2 oproepposten met automatische overschakeling
- Mogelijkheid om de bussen te verlengen met extra apparaat
- Configuratie van de apparaten met overbruggingen en dip-switches
- Aansluitingen op het systeem met verwijderbare aansluitklemmen.

## Deurplaat

- Tegen vandalisme bestande deurplaat Mod. MIKRA2 met bedekking van weersbestendig zamak, met één of twee knoppen
- Installatie tegen de wand (standaard), kan ingebouwd worden met de daarvoor voorbehouden kit
- Kleurencamera op de deurplaat met breedhoeklens en ledverlichting van de oproeper in beeld
- Lezer voor MIFARE-naderings sleutels
- Wit naamplaatje met achtergrondverlichting
- Inschakeling van het elektrische voordeurslot met impulsenthyristorontsteking, houdstroom en programmeerbare inschakeltijd
- Klaar voor aansluiting van een knop in de hal om het elektrische voordeurslot ter plaatse te bedienen
- Klaar voor de aansluiting van de sensor voor de functie DEURSTATUS of LETTERBOX
- Inschakeling van het elektrische voordeurslot voor voetgangers door benadering van de deurplaat met de meegeleverde benaderings sleutels
- Besturing van het elektrische slot op de inrijpoort met relais met droge contacten
- Bevestiging doorgestuurde oproep met akoestisch signaal en uitschakeling van de led's voor de achtergrondverlichting van het naamplaatje
- Inschakeling van de led's van de camera tijdens de oproep met mogelijkheid tot uitsluiting
- Mogelijkheid om het volume te regelen van de luidspreker in de deurplaat
- Visuele en akoestische waarschuwing voor de status van het systeem (DDA), functie alleen beschikbaar voor de deurplaat voor één woning
- Ingebouwde regendichte microfoon.

## Binnenpost

- Handenvrije video-intercombinnenposten Mod. VMODO met kleuren-LCD scherm van 7” en capacitief touch-screen
- Installatie tegen de wand (standaard), kan ingebouwd worden met daarvoor voorbehouden kit
- Gebruikersinterface in diverse talen (IT, EN, FR, ES, DE, CS, NL, NO, PL, PT, SK, VLS)
- Handenvrij of met ingedrukte toets communiceren (“Push to talk” modus):
  - Handenvrije communicatie: met een druk op de oproeptoets wordt het gesprek ingeschakeld, een tweede keer drukken schakelt het gesprek uit
  - Push to talk: met ingedrukte oproeptoets kan men praten bij de interne post; met losgelaten toets luisteren
- Oproeptonen: 5 standaard en 1 zelf gekozen

- Mogelijkheid om diverse oproeptonen toe te wijzen afhankelijk van de oproeppost (deurplaat, binnenpostoproep, oproep aan verdieping, waarschuwing voor alarm);
- Uitgerust met:
  - Telefoonversterker voor slechthorenden (ILA);
  - 2 configureerbare relaisuitgangen met droge contacten voor de inschakeling van extra opdrachten
  - Achtergrondverlichting van de aanraaktoetsen met rode of groene led's
- Mogelijkheid om direct te verbinden met de video-intercom:
  - Een plaatselijke TVCC-camera nr. 1092/250A;
  - Een toets voor oproep aan verdieping alleen op de "Master";
  - Een temperatuurvoeler Yokis THERMPROBE (Cod. 5454488);
  - Een alarmcontact alleen op de "Master";
- Mogelijkheid om op elke video-intercom een extra bel aan te sluiten of een draadloze telefoonversterker (alleen voor de Franse markt)
- Mogelijkheid om de beeldweergaveverhouding te wijzigen van 4:3 in 16:9
- Regelbaar volume (luidspreker) en instelbaar videobeeld (lichtsterkte, contrast en kleur)
- Regelbaar oproepvolume met mogelijkheid om het volume getimed uit te schakelen (mute-functie)
- Uitschakelbaar akoestisch signaal om het indrukken van een toets te bevestigen
- Houder voor extern geheugen: microSD (alleen mogelijk als de video-intercom tegen de wand wordt geïnstalleerd)
- Kalender- en klokfuncties met 2 uur back-uptijd tijdens een netstroomonderbreking
- Mogelijkheid om het plaatje voor de video-intercomtoetsen te vervangen door een andere in een andere kleur
- Klaar voor trapverlichtingbediening met relais
- Home automation-toepassingen (Yokis)
- Meten en regelen van temperatuur in de woning zelf (thermostaatfunctie) met optionele temperatuurvoeler
- Mogelijkheid om post in de brievenbus te melden (functie LETTERBOX, alleen voor de master-video-intercom met optionele apparatuur)
- Waarschuwingled's voor: ingeschakelde video-intercom, oproep of gesprek bezig, mute actief, inschakeling draadloze module Yokis, voordeur open gebleven, automatische deuropener actief, doorverbindingsfunctie actief, alarmfunctie actief, alarm bezig, post in de brievenbus (functie LETTERBOX), nieuwe vocale post-its (POST-IT), melding nieuwe video-opnamen
- Mogelijkheid om de historiek van de toegangscontrole en alarmmeldingen te raadplegen

### **Basisfuncties**













- Video-oproep door buitenpost
- Inschakeling elektrisch voordeurslot en tweede slot (inrijpoort), alleen na een oproep of automatische inschakeling
- Automatische inschakeling audio/video op deurplaat
- Oproep tussen afzonderlijke video-intercoms van dezelfde woning
- Groepsoproep aan alle video-intercoms van dezelfde woning
- Groepsoproep aan video-intercoms van verschillende woningen (functie alleen ter beschikking met kit nr. 1723/96).













### **Extra functies**

- Mogelijkheid om tot 4 TvCC-camera's op te nemen in het systeem met voorbehouden apparatuur
- Functie met cyclische automatische inschakeling, door elke willekeurige video-intercom, op de oproepposten, op de eigen camera en op de TVCC-camera's in het systeem
- Alleen met de master-video-intercom:
  - Actieve de doorverbindingsfunctie van een audio-video-oproep of alleen een audio-oproep naar een smartphone of tablet met besturingssysteem Android of IOS;
  - Een antwoordapparaat met video inschakelen om tot 32 videoboodschappen van 10 s te registreren
  - Een geregistreeerde vocale boodschap naar de oproeper sturen (maximum 20 s);
  - Een video-opname maken tijdens de oproep (tot 32 opnamen van 20 s);
- Mogelijkheid om korte vocale boodschappen (POST-IT) te registreren met een willekeurige video-intercom in het systeem (max.32 meldingen van 20 s);
- Mogelijkheid om het elektrische voordeurslot automatisch in te schakelen na een oproep

















- Mogelijkheid om een video op te nemen en ook op te slaan op microSD;
- Mogelijkheid om de microfoon uit te sluiten
- Mogelijkheid om datum en uur weer te geven, met agenda als extra functie
- Alarmdetectie:
  - Waarschuwing met led's en akoestische signalen op de video-intercom
  - Versterking van het akoestisch signaal met een sirene
  - Inschakeling van een camera om de beelden op te nemen met automatische registratie van een videoboodschap
- Inschakeling van draadloze modules Yokis met een willekeurige video-intercom
- Het inschakelen van draadloze Yokis-modules programmeren voor herhaling één of meerdere per week
- Doorsturen van de oproep en/of het alarm naar een smartphone, met voorbehouden apparatuur
- Mogelijkheid om de firmware voor het systeem bij te werken met de microSD















## 2 SAMENSTELLING VAN DE KIT

Beschrijving		Nr.	ID	
Deurplaat (A)	Deurplaat Mod. MIKRA2 met 1 oproeptoets (alleen in de kit nr. 1723/95)	1		A1
	Deurplaat Mod. MIKRA2 met 2 oproeptoetsen (alleen in de kit nr. 1723/96)	1		A2
	Schroeven voor wandbevestiging (ø 3,5 x 32 mm)	4		A3
	Pluggen voor wandbevestiging (ø 5 mm)	4		A4
	Inzetstuk voor schroevendraaier (ø 2 mm)	1		A5
	Grijs naamplaatje (1 stuk in de kit nr. 1723/95, 2 stuks in de kit nr. 1723/96)	1/2		A6
	Transparant naamplaatje (1 stuk in de kit nr. 1723/95, 2 stuks in de kit nr. 1723/96)	1/2		A7
	Reserve-inbusschroef om de deurplaat te sluiten (M3 x 12mm)	1		A8
	Master-sleutel MIFARE om te programmeren	1		A9
	Transponder-sleutels MIFARE (5 stuk in de kit nr. 1723/95, 10 stuks in de kit nr. 1723/96)	5/10		A10
	Chip tag (2 stuks in de kit nr. 1723/95, 4 stuks in de kit nr. 1723/96)	2/4		A11
	Scherf van ferriet voor chip tag (2 stuk in de kit nr. 1723/95, 4 stuks in de kit nr. 1723/96)	2/4		A12
	Gebbruiksaanwijzingen voor de chip tag (1 stuk in de kit nr. 1723/95, 2 stuks in de kit nr. 1723/96)	1/2		A13

Binnenpost (B)	“Master” video deurtelefoon 7 “speakerphone Mod. VMODO (1 stuk in de kit nr. 1723/95, 2 stuks in de kit nr. 1723/96)	1/2		B1
	Beugel voor wandbevestiging (1 stuk in de kit nr. 1723/95, 2 stuks in de kit nr. 1723/96)	1/2		B2
	Schroeven voor wandbevestiging (ø 2,9 x 32 mm) (4 stuk in de kit nr. 1723/95, 8 stuks in de kit nr. 1723/96)	4/8		B3
	Pluggen voor wandbevestiging (ø 5 mm) (4 stuk in de kit nr. 1723/95, 8 stuks in de kit nr. 1723/96)	4/8		B4
	Schroeven voor bevestiging in inbouwdoos Mod. 503 (M3,5 x 19 mm) (2 stuk in de kit nr. 1723/95, 4 stuks in de kit nr. 1723/96)	2/4		B5
	Lichter om de bedekking van de video-intercom te verwijderen (1 stuk in de kit nr. 1723/95, 2 stuks in de kit nr. 1723/96)	1		B6
	6-wegkabeltje voor aansluiting van optionele apparaten (1 stuk in de kit nr. 1723/95, 2 stuks in de kit nr. 1723/96)	1/2		B7
	Verwijderbare klemmenborden voor aansluiting van de video-intercom op het systeem (2 stuk in de kit nr. 1723/95, 4 stuks in de kit nr. 1723/96)	2/4		B8
	2-draadskabeltje voor aansluiting van een optionele temperatuurvoeler (1 stuk in de kit nr. 1723/95, 2 stuks in de kit nr. 1723/96)	1/2		B9
	Voeding (C)	Systeemvoeding	1	
Inductiespoel audio video		1		C2
(D)	Videoverdeler (alleen in de kit nr. 1723/96)	1		D

### 3 EXTRA APPARATUUR

Beschrijving		Max. aantal (in geval van maximum configuratie van het systeem)	ID
Elektrisch slot (12V~ Max 15VA)	-	2 (één per deurplaat)	 OP1
Knop voor in/uitschakeling van het elektrische voordeurslot	-	2 (één per deurplaat)	 OP2
Relaisschakelcontacten voor de inrijpoortopener (max. omschakelbare stroom 1 A @ 30 V)	-	2 (één per deurplaat)	 OP3
Sensor open deur	nr. 1033/701	2 (één per deurplaat)	 OP4 (*)
Draadloze bel (alleen ter beschikking voor de Franse markt)	cod. 43410	12 (3 per video-intercom)	 OP5 (**)
Extra bel (max 4 met nr. 1723/95, max 8 met nr. 1723/96)	nr. 9854/43	4/8 (één per video-intercom)	 OP5A (**)
Extra "Slave" video-intercoms Mod. VMODO 7" handenvrij (max 3 met nr. 1723/95, max 6 met nr. 1723/96)	nr. 1723/97	3/6	 OP6
Magnetische alarmsensor	nr. 1033/701	2 (één per master-video-intercom)	 OP7
Meldingsensoren (NC in afwezigheid van signalering)	nr. 1033/012 nr. 1033/132	4 (twee per master-video-intercom)	 OP7a (#)
Toets voor oproep aan verdieping	-	2 (één per master-video-intercom)	 OP8
Secundaire deurplaat voor één woning model MIKRA2	nr. 1723/11	1	 OP9
Secundaire deurplaat twee woningen model MIKRA2	nr. 1723/12	1	 OP10
Toetsenbord voor toegangscontrole	nr. 1723/46	2 (één per deurplaat)	 OP11
Inbouwkit voor deurplaat	nr. 1723/50	2 (één per deurplaat)	 OP12
Relaisdoos voor 2 deurplaten	nr. 1723/51	1	 OP13
Tafelhouder voor handenvrije video-intercom 7" (max 4 indien met kit nr. 1723/95, max 8 indien met kit nr. 1723/96)	nr. 1723/52	4/8	 OP14
Inbouwkit voor handenvrije video-intercom 7" (max 4 indien met kit nr. 1723/95, max 8 indien met kit nr. 1723/96)	nr. 1723/60	4/8	 OP16

TVCC interface	nr. 1723/69	1		
BALUN video-apparaat, passief, 1 kanaal	nr. 1092/300A	4 (één per camera aangesloten op de TVCC interface)		OP17
Kit Mifare sleutels	nr. 1723/102	maximaal 21 sleutels in het systeem		OP18
Compacte camera AHD DAY & NIGHT met vaste 3.6 mm lens (max 4 indien met kit nr. 1723/95, max 8 indien met kit nr. 1723/96)	nr. 1092/250A	4/8 (één per video-intercom)		OP19 (#)
BALUN video-apparaat, passief, 1 kanaal	nr. 1092/300A	4/8 (één per camera nr. 1092/250A)		
Programmeerbare, inschakelbare uitgang: - als de knop Home Automation wordt ingedrukt (fabrieksinstelling inschakeling trapverlichting), - bij een alarm, - via de thermostaatfunctie.	-	-		OP20 (**)
Relais met timer 2000 W	cod. 5454462	één per kit		
Relais met spoel van 230 V~	cod. 5454081	één per kit		
2-kanalenzender voor knoppen Mod. E2BPP	cod. 5454413	1 (alleen voor kit nr. 1723/95)		OP21 (*)
4-kanalenzender voor knoppen Mod. E4BPP	cod. 5454427	2 (alleen voor kit nr. 1723/96)		
Magnetische alarmsensor (2 stuks in de kit nr. 1723/95, 4 stuks in de kit nr. 1723/96)	nr. 1033/701	2/4		
Temperatuurvoeler Yokis THERMPROBE (max 4 indien met kit nr. 1723/95, max 8 indien met kit nr. 1723/96)	cod. 5454488	4/8 (één per video-intercom)		OP22
Voeding voor camera type nr. 1092/250A	nr. 1092/800	4 (één per camera in geval van gebruik van de TVCC interface nr. 1723/69)		OP23
Plaatselijke transformator voor 1723/97 (2 stuks in de kit nr. 1723/95, 6 stuks in de kit nr. 1723/96)	nr. 1723/22	2/6 (één per slave-video-intercom)		C4
Videoverdeler (alleen aanwezig in de kit nr. 1723/96)	nr. 1723/55	1		D

(\*) De twee opties sluiten elkaar uit.

(\*\*) Zie voor meer details de paragraaf 7.5 - FUNCTIES EN RELAISCONFIGURATIES

(#) De twee opties sluiten elkaar uit.



## 4 ONDERDELEN

Beschrijving	nr.	ID	Beschrijving	nr.	ID
Systeemvoeding	1723/20	C1	Master video-intercom 7" handsfree mod. VMODO	1723/98	B1
Inductiespoel audio video	1723/112	C2	Deurplaat mod. MIKRA2 met 1 oproep-toets (alleen in de kit sch. 1723/95)	1723/11	A1
Videoverdeler	1723/55	D	Deurplaat mod. MIKRA2 met 2 oproep-toetsen (alleen in de kit sch. 1723/96)	1723/12	A2

## 5 BLOKKENBEDRADINGSSCHEMA'S

### 5.1 SYSTEEM VOOR EEN WONING

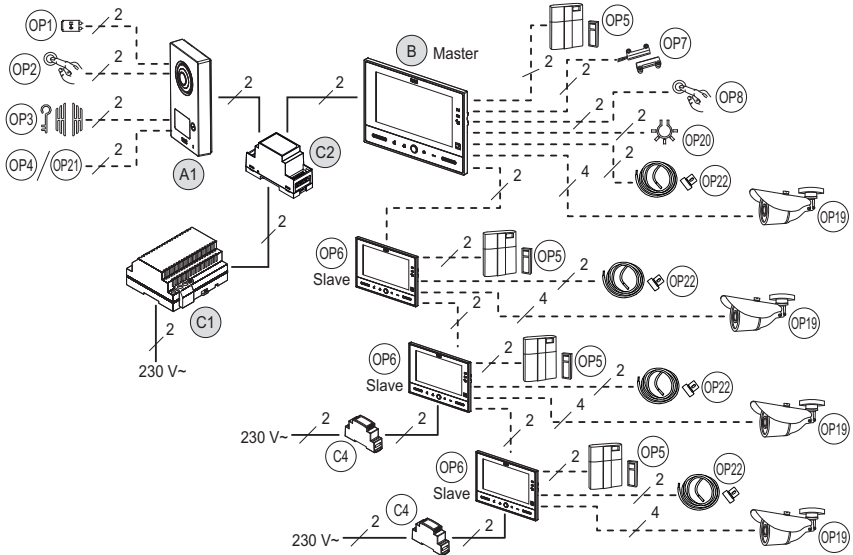

#### 5.1.1 Maximum afstand tussen de apparaten

Leidinggedeelte	Kabeltype					
	SYT1-3P-AWG20 (Ø 0,8 mm)	Getwiste telefoonkabel Ø 0,6 mm zonder mantel	CAT5	1,5 mm <sup>2</sup> enkelvoudig	2Voice	PTT278
A1 – C2	150 m	150 m	100 m	75 m	200 m	100 m
C1 – C2	0,5 m	0,5 m	0,5 m	0,5 m	0,5 m	0,5 m
C2 – versterk verwijderde video-intercom (OP6)	50 m	50 m	50 m	20 m	50 m	50 m
A – OP1	10 m	10 m	10 m	20 m	20 m	10 m
A – OP2	50 m	50 m	30 m	50 m	50 m	50 m
A – OP3	10 m	10 m	10 m	20 m	20 m	10 m
A – OP4	25 m	25 m	25 m	25 m	25 m	25 m
A – OP21	10 m	10 m	10 m	10 m	10 m	10 m
B – OP5	30 m	30 m	30 m	30 m	30 m	30 m
B – OP7	30 m	30 m	30 m	30 m	30 m	30 m
B – OP8	30 m	30 m	30 m	30 m	30 m	30 m
B – OP19	-	-	50 m	-	-	-
B – OP20	30 m	30 m	30 m	30 m	30 m	30 m
OP6 – C4	20 m	10 m	10 m	30 m	20 m	20 m
OP6 – OP5	30 m	30 m	30 m	30 m	30 m	30 m

De kabels moeten voldoen aan de norm NEN-EN-IEC 60332-1-2 als de doorsnede 0,5 mm<sup>2</sup> of groter is, of aan de norm NEN-EN-IEC 60332-2-2 als de doorsnede minder bedraagt dan 0,5 mm<sup>2</sup>.

## 5.2 TWEEWONINGENSYSTEEM

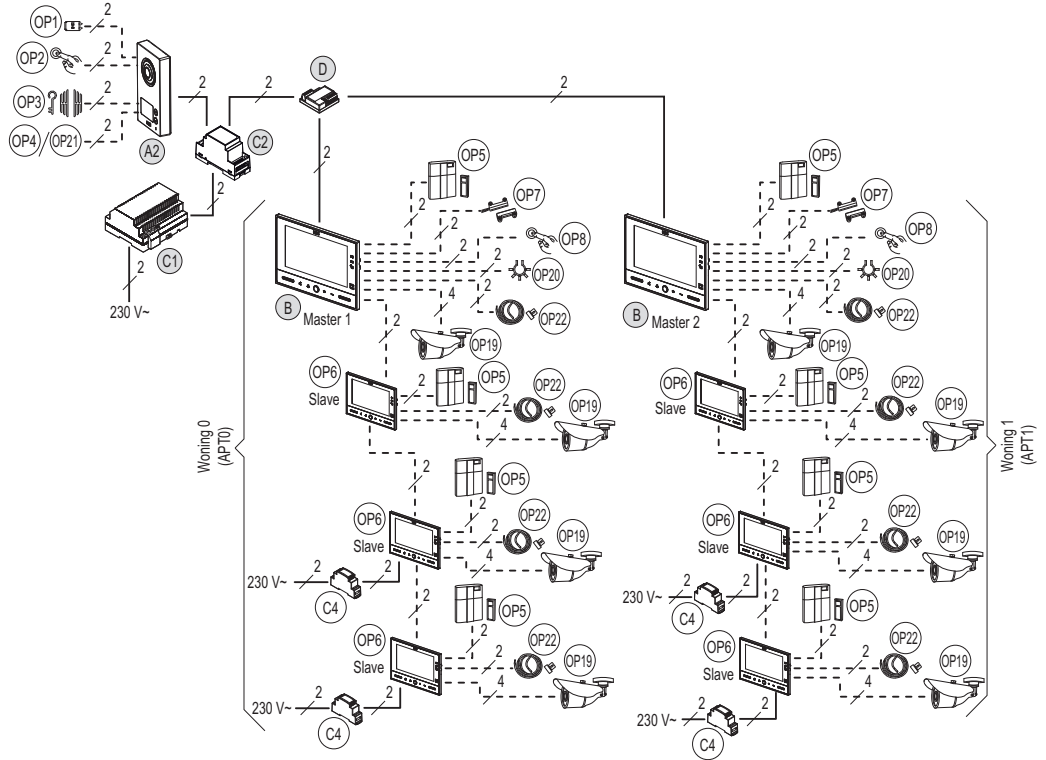

### 5.2.1 Maximum afstand tussen de apparaten

Leidinggedeelte	Kabeltype					
	SYT1-3P-AWG20 (Ø 0,8 mm)	Getwiste telefoonkabel Ø 0,6 mm zonder mantel	CAT5	1,5 mm <sup>2</sup> enkelvoudig	2Voice	PTT278
A2 – C2	150 m	150 m	100 m	75 m	200 m	100 m
C1 – C2	0,5 m	0,5 m	0,5 m	0,5 m	0,5 m	0,5 m
C2 – D	5 m	5 m	5 m	5 m	5 m	5 m
C2 – verst verwijderde video-intercom (OP6)	50 m	50 m	50 m	20 m	50 m	50 m
A – OP1	10 m	10 m	10 m	20 m	20 m	10 m
A – OP2	50 m	50 m	30 m	50 m	50 m	50 m
A – OP3	10 m	10 m	10 m	20 m	20 m	10 m
A – OP4	25 m	25 m	25 m	25 m	25 m	25 m
A – OP21	10 m	10 m	10 m	10 m	10 m	10 m
B – OP5	30 m	30 m	30 m	30 m	30 m	30 m
B – OP7	30 m	30 m	30 m	30 m	30 m	30 m
B – OP8	30 m	30 m	30 m	30 m	30 m	30 m
B – OP19	-	-	50 m	-	-	-
B – OP20	30 m	30 m	30 m	30 m	30 m	30 m
OP6 – C4	20 m	10 m	10 m	30 m	20 m	20 m
OP6 – OP5	30 m	30 m	30 m	30 m	30 m	30 m

De kabels moeten voldoen aan de norm NEN-EN-IEC 60332-1-2 als de doorsnede 0,5 mm<sup>2</sup> of groter is, of aan de norm NEN-EN-IEC 60332-2-2 als de doorsneder minder bedraagt dan 0,5 mm<sup>2</sup>.

## 6 AANWIJZINGEN VOOR DE INSTALLATEUR

---

Lees de in deze handleiding beschreven aanwijzingen aandachtig, want ze verstrekken belangrijke info omtrent de veiligheid tijdens installatie, gebruik en onderhoud.

- De apparaten waaruit de kit is samengesteld mogen uitsluitend worden gebruikt voor het doel waarvoor ze uitdrukkelijk ontworpen zijn. Elk ander gebruik wordt als oneigenlijk beschouwd. De fabrikant kan niet aansprakelijk worden gesteld voor eventuele schade voortkomend uit oneigenlijk en afwijkend gebruik.
- Elk onderdeel werd ontworpen in overeenstemming met de wettelijk geldende voorschriften.
- De installatie moet uitgevoerd worden in overeenstemming met de wettelijk geldende voorschriften. Alle apparaten waaruit de installatie is samengesteld mogen uitsluitend gebruikt worden voor het doel waarvoor ze ontworpen zijn.
- Controleer of de uitgekakte onderdelen in goede staat verkeren.
- Houd het verpakkingsmateriaal (plastic zakken, schuimpolystyrol e.d.) buiten het bereik van kinderen om mogelijk gevaar te voorkomen.
- Plaats ter beveiliging, stroomopwaarts van de apparaten, een geschikte scheidingschakelaar, waarvan de openingscontacten zich op minstens 3mm afstand bevinden.
- Alvorens de voedingsapparaten aan te sluiten eerst controleren of de gegevens op het typeplaatje overeenkomen met die van het distributienet.
- Sluit de openingen of spleten voor ventilatie of warmteafvoer nooit af.
- Zet de hoofdschakelaar van de installatie uit om de apparaten van de stroom los te koppelen alvorens schoonmaak- of onderhoudswerkzaamheden uit te voeren.
- Maak niet schoon met sprayproducten.
- Wanneer de producten waaruit de kit is samengesteld defect zijn of slecht werken, de hoofdschakelaar uitzetten en niet aan de installatie sleutelen.
- Eventuele reparaties uitsluitend laten uitvoeren bij een door de fabrikant erkend technisch assistentiecentrum.
- Zorg voor goede ventilatie.
- Maak voor de netvoedingskabel geen gebruik van verlengkabels.
- Wanneer er vloeistof of voorwerpen in het apparaat binnendringen, het laten controleren en eventueel repareren door gekwalificeerd personeel.
- Maak voor reparatie uitsluitend gebruik van de originele onderdelen van de fabrikant.
- De installateur moet controleren of de afgeleide apparaten over de gebruikersinformatie beschikken.
- Indien dit niet het geval is kan het de veiligheid van de installatie in het gedrang brengen.
- Deze handleiding moet het apparaat altijd vergezellen.
- Een gelijkzijdige driehoek met bliksemschicht geeft aan dat er gevaarlijke spanning aanwezig is.



- Maak de apparaten niet open mits het in deze handleiding vermeld wordt.
- Een gelijkzijdige driehoek met een uitroepteken duidt op onderdelen die kritiek zijn voor de veiligheid; gebruik daarom uitsluitend originele onderdelen van de fabrikant.



## 7 INSTALLATIE VAN DE VIDEO-INTERCOM

### 7.1 BESCHRIJVING VAN DE COMPONENTEN

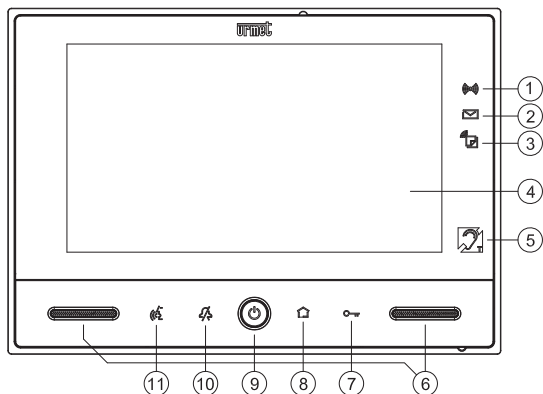

#### Paneel:

1. Pictogram Alarm
2. Pictogram waarschuwing voor post in de brievenbus (functie LETTERBOX)
3. Pictogram waarschuwing antwoordapparaat actief (groen lampje) / voice-meldingen POST-IT aanwezig (rood knipperlicht) / doorverbindingsfunctie actief (geel lampje) (alleen Master video-intercom Sch. 1723/98).
4. Display 7"
5. Pictogram dat signaleert dat de video-intercom versterkt wordt voor slechthorenden
6. Luidsprekers
7. Toets (touch) deuropener
8. Pictogram bevestiging ontvangst Yokis-opdracht
9. Schakeltoets ON/OFF
10. Knop (touch) "MUTE"
11. Knop (touch) telefoon inschakelen

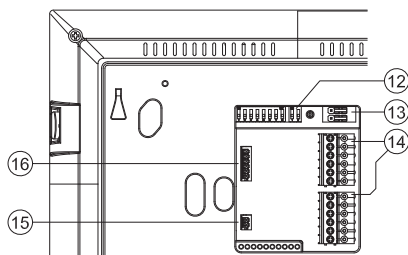

#### Achterkant:

12. Dip-switch voor configuratie
13. Overbruggingen
14. Verwijderbare aansluitklemmen met 6 pinnen
15. Connector met 2 pinnen voor externe thermostaat
16. Connector met 6 pinnen voor aansluiting externe camera / relais 2 (OP20)

## 7.2 INSTALLATIE

- Bevestig de beugel aan de wand met een 503-doos en de meegeleverde schroeven of een doos van  $\varnothing$  60 mm met geschikte schroeven.
- De dip-switches programmeren en kabels aansluiten op de aansluitklemmen van het systeem.
- Hang de video-intercom aan de beugel aan de 4 haken aan de zijkanten.
- Verwijder de beschermfolie van het display.

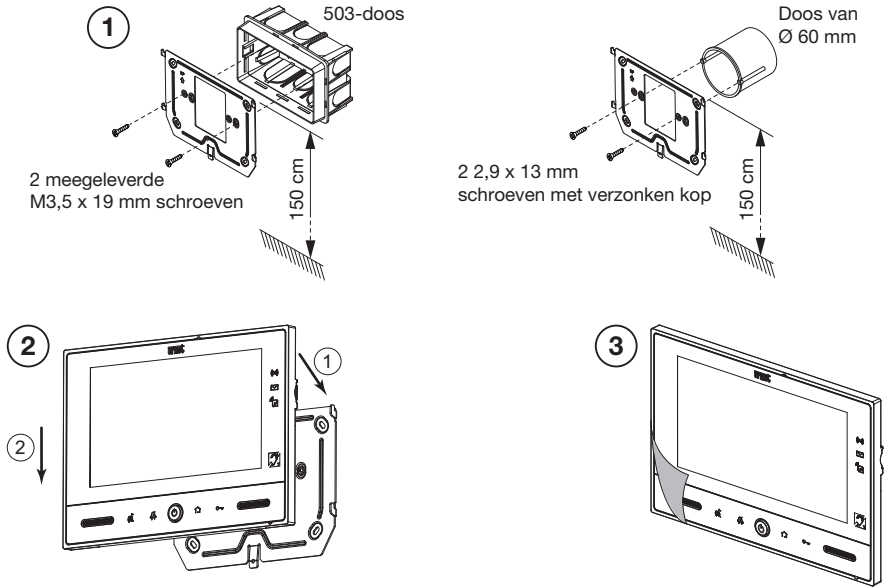

Verwijder de beschermfolie van het display van de video-intercom.

## 7.3 BESCHRIJVING VAN DE KLEMMENBORDEN

Klemmenbord	Naam klem	Beschrijving
1	LI	Bus-ingang (LINE IN)
	LI	
	LO	Bus-uitgang (LINE OUT)
	LO	
2	LP	24Vca plaatselijke voedingsstroom
	LP	
2	FC	Oproep aan verdieping
	FC	
	0	Extra bel (uitgang relais 1 – OP5 / OP5A)
	C	
	AL	Ingang alarmsensor
AL		

## 7.4 BESCHRIJVING VAN DE CONNECTOR VOOR DE EXTERNE CAMERA / RELAIS 2 (OP20)

De master-video-intercom kan worden aangesloten op de externe camera nr. 1092/250A met het meegeleverde kabeltje (B7).

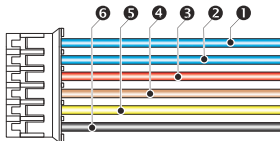

Nr. draad	Kleur van draad	Beschrijving	Naam van de pin op de connector
1	Blauw	Trapverlichting (relaisuitgang 2 – OP20)	RELAY SPARE
2	Blauw	Trapverlichting (relaisuitgang 2 – OP20)	RELAY SPARE
3	Rood	Positieve, cameravoeding	CCTV POWER+
4	Bruin	Negatieve signaalgeleider uit de balun-video	CCTV VIDEO-
5	Geel	Positieve sugbaakgeleider uit de balun-video	CCTV VIDEO+
6	Zwart	Negatieve, cameravoeding	CCTV POWER-

## 7.5 FUNCTIES EN RELAISCONFIGURATIES

De video-intercom heeft twee programmeerbare relais zoals beschreven in onderstaande tabel:

Relais	Mogelijke functie	Default	Referentie
1	Extra bel	✓	OP5 / OP5A
	Toets voor Home automation 1		
	Alarmsirene		
2	Toets voor Home automation 2	✓	OP20
	Alarmsirene		
	Thermostaatuuitgang		

## 7.6 CONFIGURATIE VAN DE OVERBRUGGINGEN (JP1 en JP2)

Er zijn twee overbruggingen op de video-intercom:

- JP1: om het lijneinde in te voegen. Het lijneinde moet worden geactiveerd op de video-intercom aan het einde van een lijn waar geen nieuw stuk de LINE OUT-klemmen vertrekt.

	JP1
Lijneinde ingeschakeld (default)	
Lijneinde niet geactiveerd	

- JP2: om de video-intercom te voeden met de Bus of met een plaatselijke transformator nr. 1723/22.

	JP2
Aansluitspanning uit bus-leiding (default)	
Aansluitspanning van lokale transformator	

## 7.7 CONFIGURATIE VAN DE DIP-SWITCHES

Achteraan op de video-intercom zitten 8 dip-switches.



- 🔧 De dip-switches 5, 7 en 8 worden niet gebruikt.

### 7.7.1 Toewijzing knop voor oproep aan video-intercom

	Stand dip-switch 1		Stand dip-switch 1
Video-intercom toegewezen aan de toets voor oproep 0 (bovenste)		Video-intercom toegewezen aan de toets voor oproep 1 (onderste)	

### 7.7.2 Code van de video-intercom

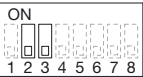
Als u de slave-video-intercoms wenst te installeren, moet op elke binnenpost de bijbehorende code worden ingesteld met de dip-switches 2 en 3.

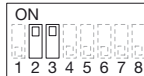
Type video-intercom	Stand dip-switch 2 en 3	Type video-intercom	Stand dip-switch 2 en 3
Master video-intercom		Slave video-intercom nr. 1	
Slave video-intercom nr. 2		Slave-video-intercom nr. 3	

### 7.7.3 Systeemtypen

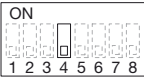
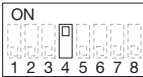
	Stand dip-switch 4		Stand dip-switch 4
Systeem voor één woning		Systeem voor twee woningen	



### 7.7.4 Telefoon inschakelen met druk op toets (modus "Push to talk")

Als de communicatie tussen de deurplaat en de video-intercom afwezig is of er zit storing op, controleert u of de beschermfolie op het display van de video-intercom is verwijderd. Als de beschermfolie is verwijderd en er zit toch nog storing op het geluid, kunnen de twee telefoonkanalen afzonderlijk worden geactiveerd (naar de woningen en naar buiten).

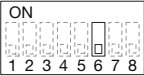
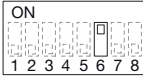
Als een oproep wordt ontvangen, drukt u even op  om de telefoon op de deurplaat in te schakelen. Als u vervolgens blijft drukken op de toets  schakelt u het audiokanaal naar buiten in en kunt u praten met de oproeper. Om te luisteren laat u de toets  los.

	Stand dip-switch 6		Stand dip-switch 6
Functie uitgeschakeld		Functie ingeschakeld	

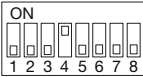
### 7.7.5 Fabrieksinstellingen:

<b>Kit voor één woning nr. 1723/95:</b>	Video-intercom	
<b>Kit voor twee woningen nr. 1723/96:</b>	Video-intercom 1	
	Video-intercom 2	

## 8 INSTALLATIE VAN DE SYSTEEMVOEDING EN AUDIO VIDEO DE INDUCTIESPOEL

De voeding moet in een stroomkast worden geïnstalleerd of in een kast.

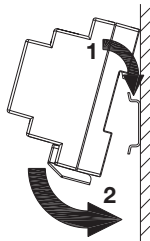

Installatie op DIN-rail (6 modules van 18 mm)

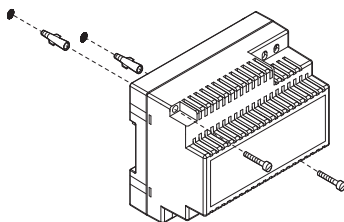

Installatie tegen de wand

De inductiespoel kan aan de wand worden bevestigd met de meegeleverde beugel of op een DIN-rail (2 modules van 18 mm).

De inductiespoel moet in de kast worden geïnstalleerd waarin ook de voeding is gemonteerd.

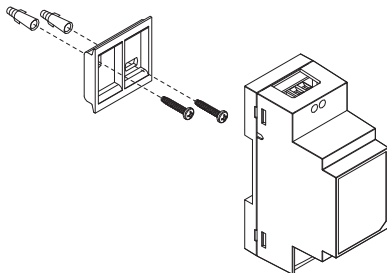

### 8.1.1 Beschrijving van de aansluitklemmen

#### Systeemvoeding nr. 1723/20

- |   |               |   |
|---|---------------|---|
| ⊗ | 110-230V~ / N | } Ingang spanning netstroomvoeding 110-230 V~ |
| ⊗ | -             |   |
| ⊗ | +             | } Uitgang aansluitspanning                    |
| ⊗ | -             |   |

#### Inductiespoel audio video nr. 1723/112

- |   |         |                           |
|---|---------|---------------------------|
| ⊗ | +       | } Ingang aansluitspanning |
| ⊗ | -       |                           |
| ⊗ | ] LINE1 | BUS-lijn 1                |
| ⊗ |         |                           |
| ⊗ | ] LINE2 | BUS-lijn 2                |
| ⊗ |         |                           |



## 9 INSTALLATIE VAN DE DEURPLAAT

### 9.1 BESCHRIJVING VAN DE COMPONENTEN

Deurplaat Mod. MIKRA2 met 1 oproep-toets  
(alleen aanwezig in de kit voor één  
woning nr. 1723/95)

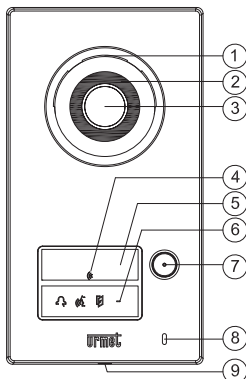

Deurplaat Mod. MIKRA2 met 2 oproep-toetsen  
(alleen aanwezig in de kit voor twee  
woningen nr. 1723/96)

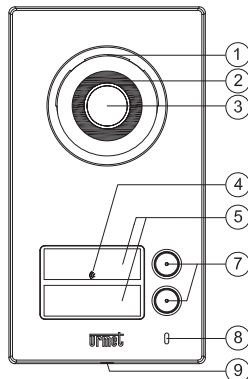

Voorkant:

1. Luidspreker
2. Verlichtingsled camera
3. Camera
4. Transponder-lezer
5. Naamplaatje/s
6. Led-waarschuwingen voor de DDA-functie
7. Oproep-toets/en
8. Microfoon
9. Schroef om de bedekking te sluiten

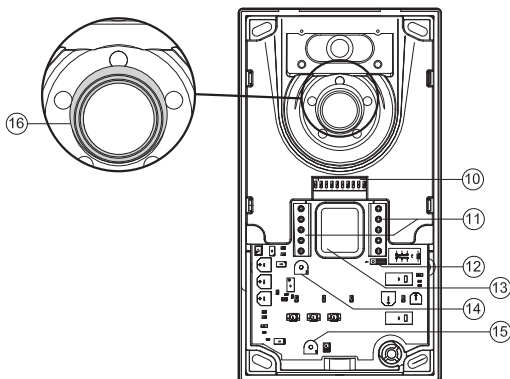

Binnenkant:

10. Dip-switch voor configuratie
11. Aansluitklemmen
12. **Wijzig de stand van deze overbrugging niet!**
13. Kabeldoorgangsopening
14. Trimmer om het volume van de luidspreker te regelen
15. **Draai niet aan deze trimmer!**
16. Antireflectie-afdichting

## 9.2 INSTALLATIE

- Installeer het deurplaat op de voorgeschreven hoogte en controleer eerst of de gebruiker in het beeld van de camera komt
- Sluit de draden aan op de klemmen
- Monteer de naamplaatjes op de voorkant
- Programmeer alles
- Regel indien nodig het volume van de luidspreker
- Sluit de deurplaat af met de metalen bedekking
- Verwijder de beschermfolie

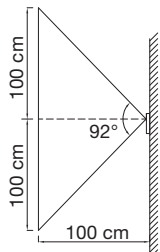

Verticaal opnameveld

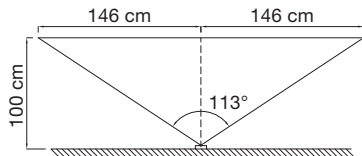

Horizontaal opnameveld

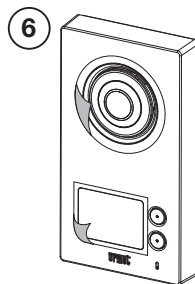
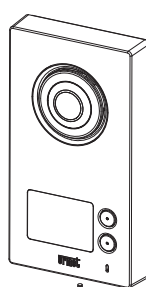
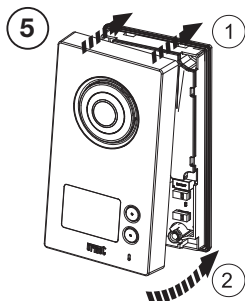
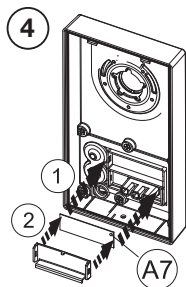
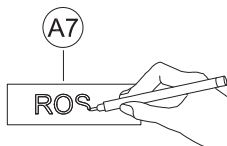
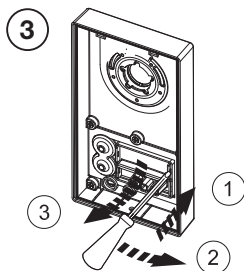
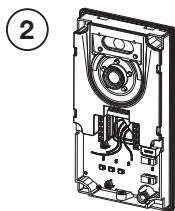
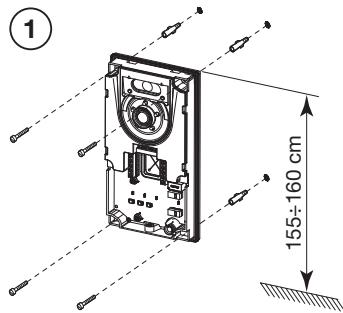

### 9.3 BESCHRIJVING VAN DE KLEMMENBORDEN

#### Linker klemmenbord

- SE- Negatieve elektrische sluisaandrijving met capacatieve ontlading
- SE+ Positieve elektrische sluisaandrijving met capacatieve ontlading
- } PA Ingang voor elektrische voetgangersvergrendelknop
- SP Sensoringang speciaal voor de functie DEELSTATUS of LETTERBOX

#### Rechter klemmenbord



- SP Ingang voor de sensor voor de functie DEURSTATUS of LETTERBOX
- } LINE Bus-lijn
- } N.O. Bekrachtiging droog contact deuropener (OP3)

### 9.4 CONFIGURATIE VAN DE DIP-SWITCHES



Het deurplaat heeft 10 dip-switches aan de binnenkant van het paneel.

⚡ **De dip-switches 6, 9 en 10 mogen niet worden gewijzigd.**



#### 9.4.1 Selectie van de functie DEURSTATUS of LETTERBOX (signalering van post in de brievenbus)

	Stand dip-switch 1		Stand dip-switch 1
Functie DEURSTATUS geactiveerd		Functie LETTERBOX geactiveerd	



#### 9.4.2 Identificatienummer van de deurplaat

	Stand dip-switch 2		Stand dip-switch 2
Deurplaat 1		Deurplaat 2	



#### 9.4.3 Inschakeling van de camera-leds tijdens de oproep

	Stand dip-switch 3		Stand dip-switch 3
Functie uitgeschakeld		Functie ingeschakeld	

#### 9.4.4 Inschakeling van de oproep van woning 0 met beide toetsen op de deurplaat (functie alleen ter beschikking met de tweewoningenkit nr. 1723/96)

	Stand dip-switch 4		Stand dip-switch 4
Functie ingeschakeld		Functie uitgeschakeld	



#### 9.4.5 Selectie van het type inschakeling van het elektrisch voordeurslot en inrijpoortslot: met thyristorontsteking of met relais met droge contacten

	Stand dip-switch 5		Stand dip-switch 5
Inschakeling van het elektrische voordeurslot met impulsthyristorontsteking en houdstroom (klemmen SE+ en SE-); Inschakeling inrijpoort met relais met droge contacten (klemmen N.O.).		Inschakeling elektrisch voordeurslot met relais met droge contacten (klemmen N.O.); Inschakeling inrijpoort met impulsthyristorontsteking en houdstroom (klemmen SE+ en SE-).	

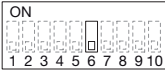
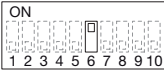
### 9.4.6 Instelling van het type deurplaat

	Stand dip-switch 6		Stand dip-switch 6
Deurplaat voor één woning		Deurplaat voor twee woningen	

### 9.4.7 Regeling van de inschakeltijd voor het elektrisch slot met thyristorontsteking

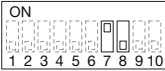
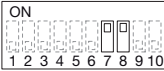
	Stand dip-switch 7-8		Stand dip-switch 7-8
0 seconden (impuls van 300 ms)		3 seconden	
6 seconden		9 seconden	

### 9.4.8 Fabrieksinstellingen

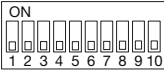
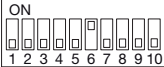
Kit voor één woning nr. 1723/95:	Deurplaat 1	
Kit voor twee woningen nr. 1723/96:	Deurplaat 2	

## 9.5 VOLUMEREGELING LUIDSPREKER

De geluidsvolumes zijn per fabriek zodanig ingesteld dat ze meestal niet moeten worden gewijzigd tijdens de installatie. Indien nodig regelt u met een schroevendraaier het volume van de luidspreker (zie punt 13 van paragraaf 9.1 - BESCHRIJVING VAN DE COMPONENTEN).

## 10 TECHNISCHE KENMERKEN

### Systeemvoeding

Voeding in CAT III 4000 V

Aansluitstroom: ..... 110-230 V~ 50-60 Hz

Vermogen: ..... 75 W max

Secundaire uitgang: ..... 50-230 V --- 1 A

Opgenomen vermogen na 1 bedrijfsuur: ..... Max 5 Wh (18 kJ)

Maten (LxHxD): ..... 108 (6 DIN-modules) x 90 x 61 mm

### Inductiespoel audio video

Maten (LxHxD): ..... 36 (2 DIN-modules) x 95 x 57 mm

### Video-intercom

Voedingsspanning: ..... met BUS 37÷48 V ---

Met plaatselijke transformator 24 V~ (+-10%)

Stroomverbruik: maximum ..... 280 mA @ 48 V ---

in ruststand (basisconfiguratie) ..... 25 mA @ 48 V ---

Opgenomen vermogen tijdens bedrijf: ..... max 16 W

LCD-display: ..... 7" IPS met achtergrondverlichting

Resolutie: ..... 1024H x 600V pixel

Gezichtsveld: ..... >±80°

Vertraagde inschakeling: ..... 2 s Max

Zendercapsule: ..... elektreetmicrofoon

Ontvangercapsule: ..... luidspreker 45 Ω

Houder voor extern geheugen: ..... microSD standaard (aanbevolen 2 GB)

Zendbereik:

- in een woning van 100m<sup>2</sup> met een draagmuur of een vloer waar het signaal door moet;
- 250 m in een open ruimte.

*In beide gevallen vermindert het zendbereik in aanwezigheid van metalen elementen, muren of schotten*

Verzending: het lampje van de zender gaat alleen branden als de verzending gelukt is. Als het signaal niet sterk genoeg is, kan toevoeging van een extra ontvanger het probleem oplossen. Lees hierover meer in de handleiding van de Yokis-zenders.

**Frequentieband:**

WiFi: ..... 2400 ÷ 2483,5 MHz  
Yokis: ..... 2400 ÷ 2480 MHz  
Mifare: ..... 13,56 MHz

**Uitgangsvermogen (max.):**

WiFi: ..... 20 dBm  
Yokis: ..... 10 dBm  
Mifare: ..... -13 dBµA/m @ 10m

Uitgang relais 1 (OP5 / OP5A) ..... 100 mA @ 24 V ---

Uitgang relais 2 (OP20 - RELAY SPARE) ..... 25 mA @ 24 V ---

Gebruikstemperatuur: ..... -5 ÷ +45° C

Max. vochtigheidsgraad: ..... 95% UR

Maten (LxHxD): ..... 202 x 142 x 22 mm

**Deurplaat**

Voedingsspanning: ..... 36÷48 V ---

Stroomverbruik: Maximum ..... 130 mA @ 48 V ---  
in rust ..... 20 mA @ 48

Opgenomen maximum vermogen tijdens bedrijf: ..... max 6,5 W

Maten (LxHxD): ..... 100 x 180 x 28 mm

Maten van het naamplaatje: ..... 48,5 x 15,5 mm

Verlichting naamplaatjes en toetsen: ..... LED wit licht

Beveiligingsgraad van de mantels: ..... IP45

Beveiligingsgraad tegen mechanische invloeden: ..... IK07

Gebruikstemperatuur: ..... -10 ÷ +50° C

Max. vochtigheidsgraad: ..... 95% UR





Maxim stroom droog contact N.O. (OP3): ..... 1 A @ 30 V ---

Zendercapsule: ..... elektreetmicrofoon

Ontvangercapsule: ..... regendichte luidspreker 16 Ω

 De kabels moeten voldoen aan de norm NEN-EN-IEC 60332-1-2 als de doorsnede 0,5 mm<sup>2</sup> of groter is, of aan de norm NEN-EN-IEC 60332-2-2 als de doorsneder minder bedraagt dan 0,5 mm<sup>2</sup>.

## 11 LEGENDE SYMBOLEN

Symbol	Uitleg
---	Continue voedingsspanning
~	Wisselende voedingsspanning
	Commerciële merknaam van het videofoonsysteem
	Voedingsapparaat voorzien van een dubbie isolatie
	GEVAAR – Aanwezigheid van gevaarlijke spanningen
	GEVAAR – Aanwezigheid van onderdelen die de veiligheid in het gedrang kunnen brengen
	Raadpleeg de installatiehandleiding van het apparaat

## 12 VEREENVOUDIGDE EU-CONFORMITEITSVERKLARING

Hierbij verklaart de fabrikant, URMET S.p.A., dat de types radioapparatuur:

**KIT VIDEO-INTERCOM MET 2 DRADEN VOOR ÉÉN EN TWEE WONINGEN MET DOORVERBINDING** (met codes 1723/95 en 1723/96) in overeenstemming zijn met Richtlijn 2014/53/EU.

De volledige tekst van de EU-conformiteitsverklaring kan worden geraadpleegd op het volgende internetadres:

[www.urmet.com](http://www.urmet.com)

DS1723-050A

13. SCHEMI DI COLLEGAMENTO - WIRING DIAGRAM - SCHÉMAS DE RACCORDEMENT  
 ESQUEMAS DE CONEXIÓN - ANSCHLUSSPLÄNE - BEDRADINGSCHEMA'S

13.1 COLLEGAMENTO DEL KIT MONOFAMILIARE Sch.1723/95 CON 3 VIDEOCITOFONI IN PARALLELO  
 ONE-HOUSEHOLD KIT CONNECTION REF.1723/95 WITH 3 VIDEO DOOR PHONES IN PARALLEL  
 RACCORDEMENT DU KIT MONO-FAMILLE REF. 1723/95 AVEC 3 MONITEURS EN PARALLELE  
 CONEXIÓN DEL KIT MONOFAMILIAR REF. 1723/95 CON 3 VIDEOINTERFONOS EN PARALELO  
 ANSCHLUSS DES EINFAMILIENHAUS-KITS BN 1723/95 MIT 3 PARALLEL GESCHALTETEN  
 VIDEOSPRECHANLAGEN  
 AANSLUITING VAN DE KIT VOOR EEN WONING NR.1723/95 MET 3 PARALLEL GESCHAKELDE  
 VIDEO-INTERCOMS

SV102-4014

F

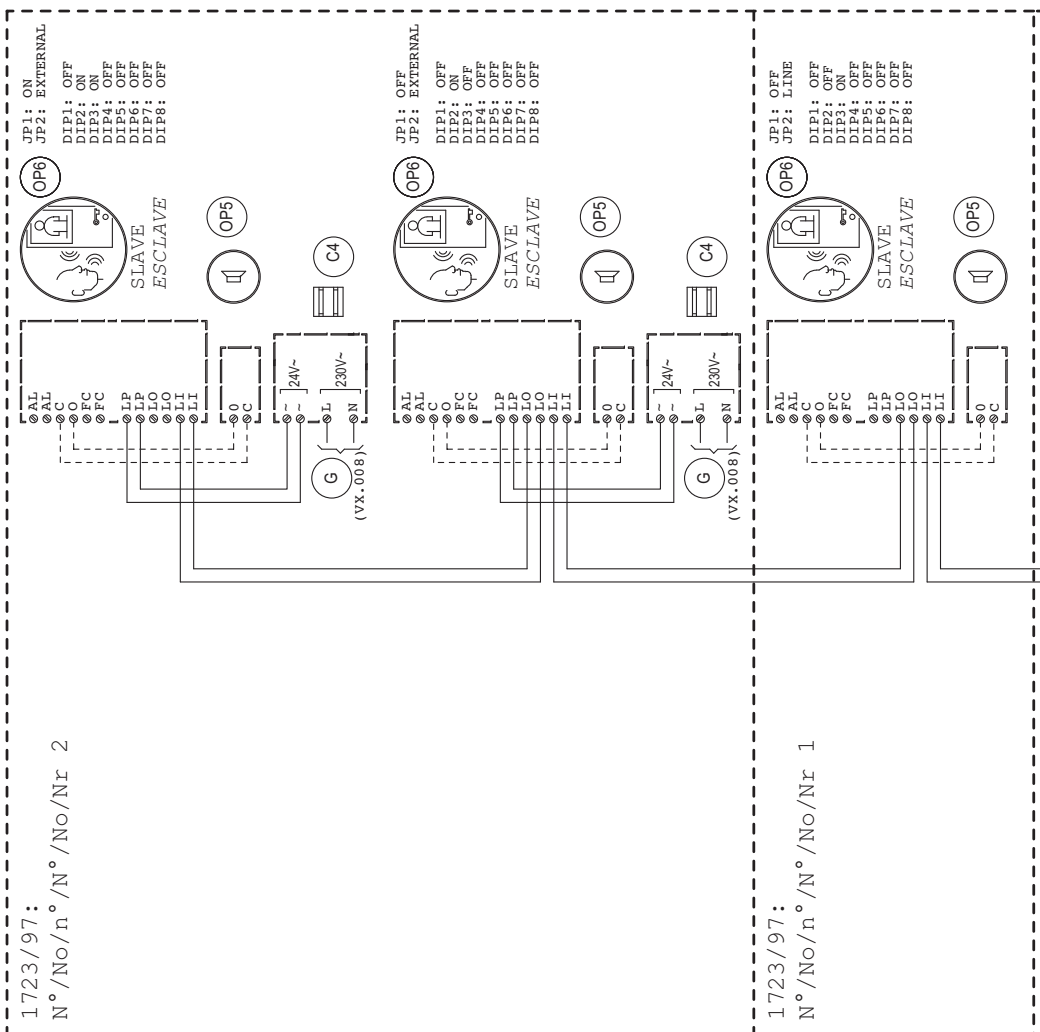

- (\*) Spostare su OFF solo se nell'impianto è presente più di un videocitofono.  
 Move to OFF only if there is more than one video door phone in the system.  
 Ne déplacer sur OFF qu'en présence de plus d'un moniteur dans l'installation.  
 Colocar en OFF sólo si en el sistema hay más de un videointerfono.  
 Nur auf OFF stellen, wenn im System mehr als eine Videoanlage vorhanden ist.  
 Alleen verplaatsen op OFF als in het systeem meer dan één video-intercom is.

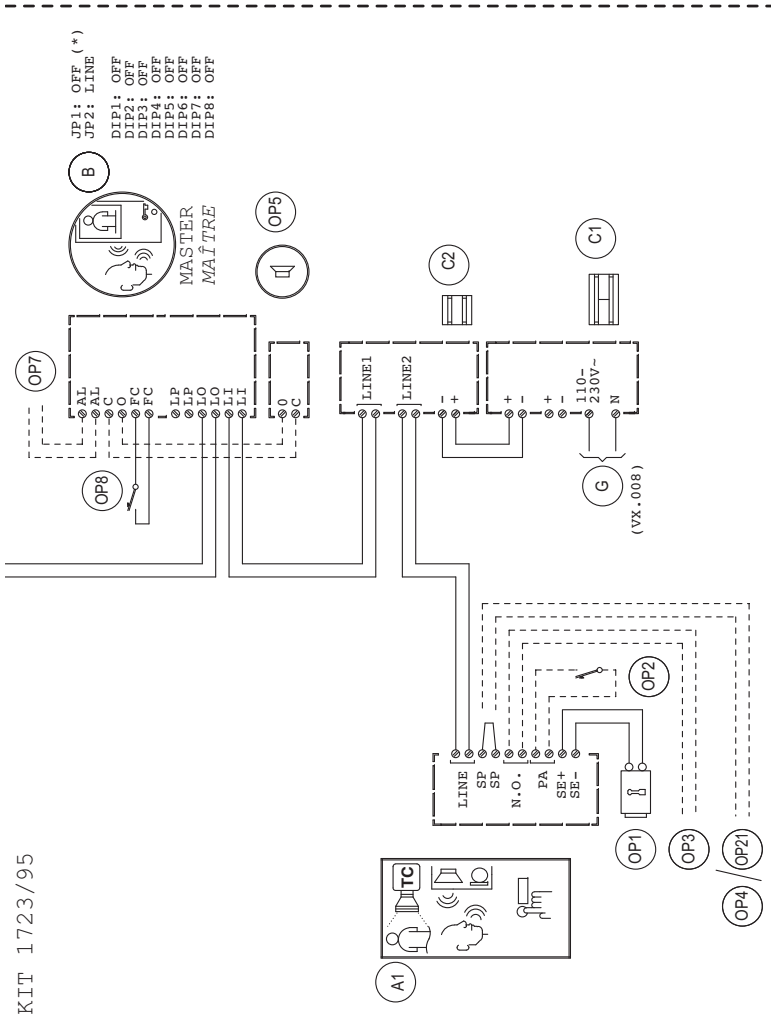

**13.2 COLLEGAMENTO DEL KIT BIFAMILIARE SCH.1723/96 CON 3 VIDEOCITOFONI IN PARALLELO AD OGNI UTENZA**

**TWO-HOUSEHOLD KIT CONNECTION REF.1723/96 WITH 3 VIDEO DOOR PHONES IN PARALLEL FOR EACH USER**

**RACCORDEMENT DU KIT BI-FAMILLE REF. 1723/96 AVEC 3 MONITEURS EN PARALLELE POUR CHAQUE APPARTEMENT**

**CONEXIÓN DEL KIT BIFAMILIAR REF. 1723/96 CON 3 VIDEOINTERFONOS EN PARALELO A CADA USUARIO**

**ANSCHLUSS DES ZWEIFAMILIENHAUS-KITS BN 1723/96 MIT 3 PARALLEL GESCHALTETEN VIDEOSPRECHANLAGEN BEI JEDEM TEILNEHMER**

**AANSLUITING VAN DE KIT VOOR TWEE WONINGEN NR. 1723/96 MET 3 PARALLEL TUSSEN ELKE VERBRUIKER GESCHAKELDE VIDEO-INTERCOMS**

SV102-4015

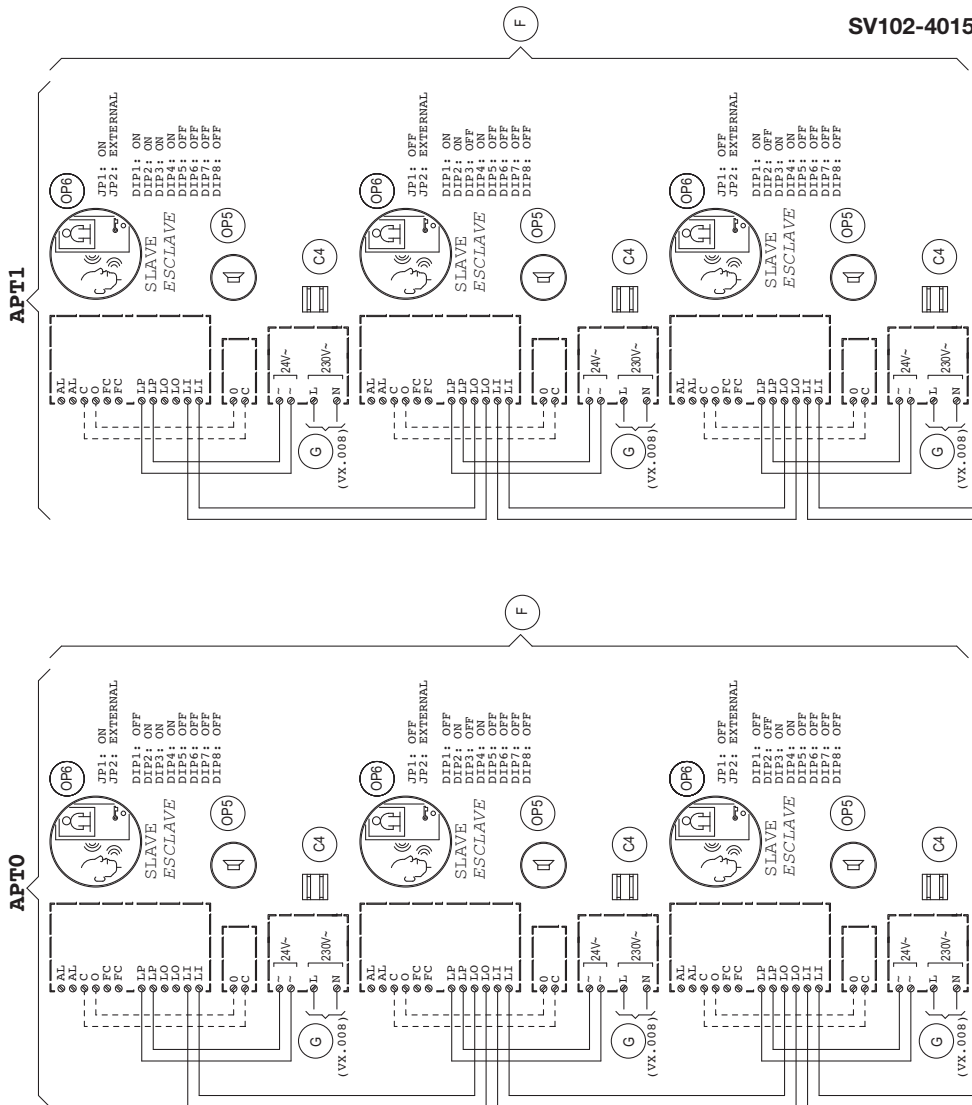



(#) Spostare su OFF solo se nell'appartamento è presente più di un videocitofono.  
 Move to OFF only if there is more than one video door phone in the apartment.  
 Ne déplacer sur OFF qu'en présence de plus d'un moniteur dans l'appartement.  
 Colocar en OFF sólo si en el apartamento hay más de un videointerfono.  
 Nur auf OFF stellen, wenn in der Wohnung mehr als eine Videoanlage vorhanden ist.  
 Alleen verplaatsen op OFF als in het systeem meer dan één video-intercom is.

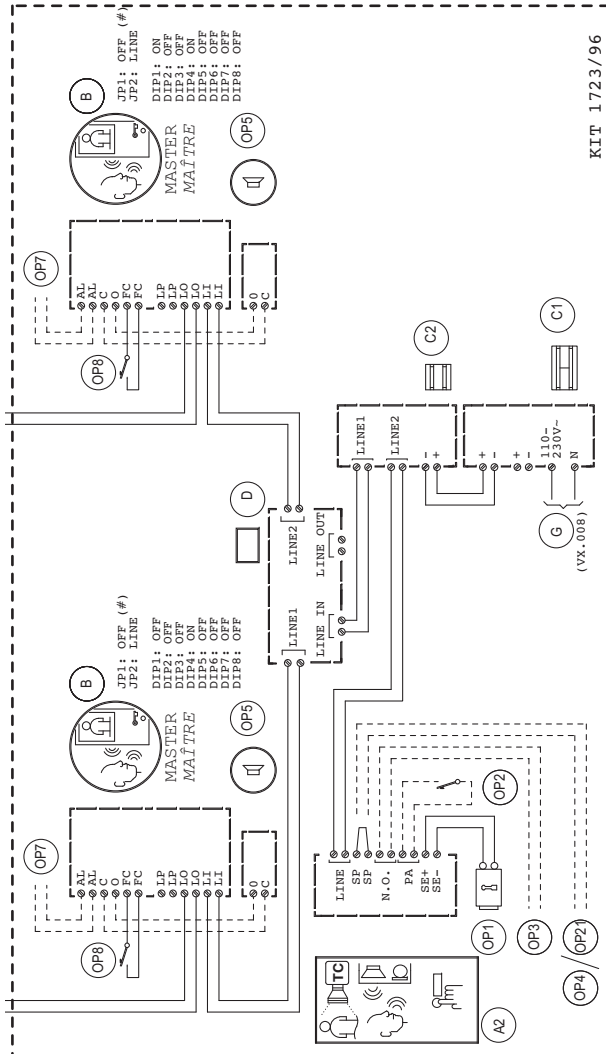

**13.3 COLLEGAMENTO DELLA SUONERIA SUPPLEMENTARE AL VIDEOCITOFONO**  
**CONNECTION OF A SUPPLEMENTARY RINGER TO VIDEO DOOR PHONE**  
**RACCORDÉMENT DE LA SONNERIE SUPPLÉMENTAIRE AU MONITEUR**  
**CONEXIÓN DEL TIMBRE ADICIONAL AL VIDEOINTERFONO**  
**ANSCHLUSS DES ZUSÄTZLICHEN LÄUTWERKES AN DIE VIDEOSPRECHANLAGE**  
**AANSLUITING VAN DE EXTRA BEL NAAR DE VIDEO-INTERCOM**

SV102-3995

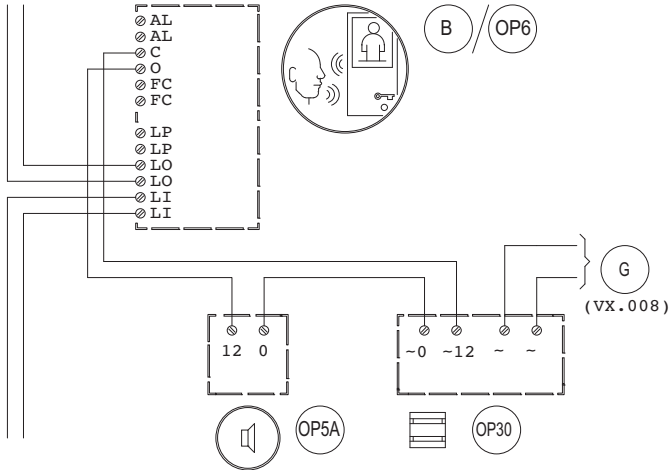

Distanze massime tra i dispositivi  
 B/OP6 - OP30: 30m  
 Maximum distances between devices  
 B/OP6 - OP30: 30m  
 Distances maximales entre les dispositifs  
 B/OP6 - OP30: 30m  
 Distancias máximas entre los dispositivos  
 B/OP6 - OP30: 30m  
 Maximale Abstände zwischen den Geräten  
 B/OP6 - OP30: 30m  
 Maximum afstand tussen de apparaten  
 B/OP6 - OP30: 30m

**13.4 LEGENDA SCHEMI - DIAGRAM KEY - LEGENDE DES SCHEMAS - LEYENDAS DE LOS DIAGRAMAS  
LEGENDE DER PLÄNE - LEGENDE SCHEMA'S**

<b>Rif. / Ref. Réf. / Ref. Bez. / Ref.</b>	<b>Descrizione / Description Description / Descripción Beschreibung / Beschrijving</b>	<b>Sch. / Ref. Réf. / Ref. Typ / Nr.</b>
A1	<p>Pulsantiera Mod. MIKRA2 con 1 tasto di chiamata (presente solo nel kit monofamiliare sch. 1723/95) <i>Panel model MIKRA2 with 1 calling button (present only in one-household kit ref. 1723/95)</i></p> <p>Plaque modèle MIKRA2 avec 1 touche d'appel (uniquement dans le kit mono-famille réf. 1723/95) <i>Teclado Mod. MIKRA2 con 1 pulsador de llamada (presente sólo en el kit monofamiliar ref. 1723/95)</i></p> <p>Tastenfeld Mod. MIKRA2 mit 1 Ruftaste (nur vorhanden im Einfamilienhaus-Kit Typ 1723/95) <i>Deurplaat Mod. MIKRA2 met 1 oproep-toets (alleen in de kit voor één woning nr. 1723/95)</i></p>	-
A2	<p>Pulsantiera Mod. MIKRA2 con 2 tasti di chiamata (presente solo nel kit bifamiliare sch. 1723/96) <i>Panel model MIKRA2 with 2 calling buttons (present only in two-household kit ref. 1723/96)</i></p> <p>Plaque modèle MIKRA2 avec 2 touches d'appel (uniquement dans le kit bi-famille réf. 1723/96) <i>Teclado Mod. MIKRA2 con 2 pulsadores de llamada (presente sólo en el kit bifamiliar ref. 1723/96)</i></p> <p>Tastenfeld Mod. MIKRA2 mit 2 Ruftasten (nur vorhanden im Zweifamilienhaus-Kit Typ 1723/96) <i>Deurplaat Mod. MIKRA2 met 2 oproep-toetsen (alleen in de kit voor twee woningen nr. 1723/96)</i></p>	-
B	<p>Videocitofono "Master" 7" vivavoce Mod. VMODO <i>Video door phone Mod. VMODO Master</i></p> <p>Moniteur modèle VMODO "Maître" <i>Videointerfono Mod. VMODO "Master"</i></p> <p>Videoanlage Mod. VMODO "Master" <i>Video-intercom 7" speakerphone Mod. VMODO "Master"</i></p>	-
C1	<p>Alimentatore di sistema <i>System power supply unit</i></p> <p>Alimentation système <i>Alimentador del sistema</i></p> <p>Systemnetzteil <i>Systeemvoeding</i></p>	1723/20
C2	<p>Induttanza audio video <i>Audio video inductor</i></p> <p>Inductance audio/vidéo <i>Inductancia audio video</i></p> <p>Systemnetzteil <i>Inductiespoel audio video</i></p>	1723/112
C4	<p>Trasformatore locale per 1723/97 <i>Local transformer for 1723/97</i></p> <p>Transformateur local pour 1723/97 <i>Transformador local para 1723/97</i></p> <p>Lokaler Transformator für 1723/97 <i>Plaatselijke transformator voor 1723/97</i></p>	1723/22
D	<p>Distributore video (presente solo nel kit sch. 1723/96) <i>Video distributor (present only in kit ref. 1723/96)</i></p> <p>Distributeur vidéo (uniquement dans le kit réf. 1723/96) <i>Distribuidor vídeo (presente sólo en el kit ref. 1723/96)</i></p> <p>Videoverteiler (nur vorhanden im Kit Typ 1723/96) <i>Videoverdeler (alleen aanwezig in de kit nr. 1723/96)</i></p>	1723/55

F	Opzionali / <i>Optional</i> / Options / <i>Opcionales</i> / Optionen / <i>Opties</i>	-
G	Linea~ / <i>Line~</i> / Ligne~ / <i>Línea~</i> / Leitung~ / <i>Lijn~</i>	-
OP1	Serratura elettrica (12Vca Max 15VA) <i>Electric lock (12Vac Max. 15VA)</i> Serrure électrique (12Vca Maxi 15VA) <i>Cerradura eléctrica (12 V~ Máx. 15 VA)</i> Elektroverriegelung (12 V~, max. 15 VA) <i>Elektrisch slot (12Vca Max 15VA)</i>	-
OP2	Pulsante per azionamento serratura elettrica pedonale <i>Button for pedestrian gate electric lock</i> Bouton de commande de la serrure électrique pour piétons <i>Pulsador de accionamiento de la cerradura eléctrica para peatones</i> Taste zur Betätigung der Elektroverriegelung des Eingangs <i>Knop voor de in/uitschakeling van het elektrische voordeurslot</i>	-
OP3	Contatti del relè per l'attivazione apriporta passo carraio <i>Relay contacts for garage gate lock activation device</i> Contacts du relais pour l'activation de l'accès véhicules <i>Contactos del relé para la activación de la apertura de la puerta del pasaje para vehículos</i> Relaiskontakt für die Türöffneraktivierung Zufahrt <i>Relaiscontacten voor de inschakeling inrijpoort</i>	-
OP4 / OP21	Sensore porta aperta / funzione LETTERBOX <i>Open door sensor / LETTERBOX function</i> Capteur de porte ouverte / fonction LETTERBOX <i>Sensor de puerta abierta / función LETTERBOX</i> Tür offen-Sensor / funktion LETTERBOX <i>Sensor open deur / functie LETTERBOX</i>	1033/701 / -
OP5	Suoneria Radio (disponibile solo su mercato francese) <i>Radio ringer (available for the French market only)</i> Sonnerie radio (uniquement disponible sur le marché français) <i>Timbre Radio (disponible sólo para el mercado francés)</i> Funkläutwerk (nur auf dem französischen Markt erhältlich) <i>Draadloze bel (alleen ter beschikking voor de Franse markt)</i>	43410
OP5A	Suoneria supplementare <i>Supplementary ringer</i> Sonnerie supplémentaire <i>Timbre adicional</i> Zusätzliches Läutwerk <i>Extra bel</i>	9854/43
OP6	Videocitofoni "Slave" supplementari 7" vivavoce Mod. VMODO <i>Supplementary "Slave" video door phones Mod. VMODO 7" hands-free</i> Moniteurs "Slave" supplémentaires modèle VMODO 7" mains-libres <i>Videointerfonos "Slave" adicionales Mod. VMODO 7" manos libres</i> Zusätzliche "Slave" Videosprechanlagen Mod. VMODO 7" Freisprechfunktion <i>Extra video-intercoms "Slave" mod. VMODO 7" handenvrij</i>	1723/97
OP7	Sensore di allarme magnetico <i>Magnetic alarm sensor</i> Contact magnétique d'alarme <i>Sensor de alarma magnético</i> Magnetischer Alarmsensor <i>Magnetische alarmsensor</i>	1033/701
OP8	Pulsante di chiamata al piano <i>Floor call button</i> Touche d'appel palier <i>Pulsador de llamada al piso</i> Taste für den Anruf auf der Etage <i>Toets voor oproep aan verdieping</i>	-

OP30	Trasformatore 12 V~ Transformer 12 Vac Transformateur 12 V~ Transformador 12 V~ Transformator 12 V~ Transformator 12 V~	9000/230
------	--	----------

### 13.5 NOTE LEGATE AGLI SCHEMI

#### NOTES ON DIAGRAMS

#### REMARQUES CONCERNANT LES SCHÉMAS

#### NOTAS REFERIDAS A LOS ESQUEMAS

#### HINWEISE IN VERBINDUNG MIT DEN PLÄNEN

#### OPMERKINGEN OMTRENT DE SCHEMA'S

#### VX.008 (Rev. A)

Connettere le apparecchiature ad un filtro e a un dispositivo di protezione per la linea d'alimentazione.

*Connect the devices to a filter and power line protection device.*

Connecter les appareils à un filtre et à un dispositif de protection pour la ligne d'alimentation.

*Conectar los equipos a un filtro y a un dispositivo de protección para la línea de alimentación.*

Die Geräte an einen Filter oder eine Schutzvorrichtung für die Versorgungsleitung anschließen.

*Sluit de apparaten aan op een filter en op een systeem voor de beveiliging van de voedingslijn.*

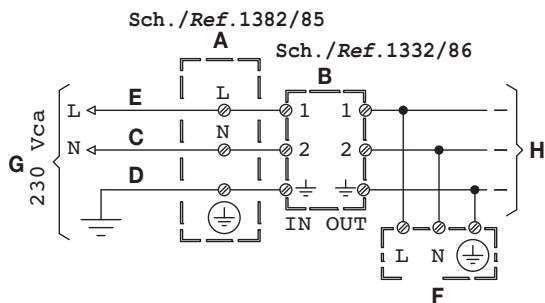

- |   |   |  |   |
|---|---|--|---|
| <b>A)</b> Protezione<br><i>Protection</i><br>Protection<br><i>Protección</i><br>Schutz<br>Bescherming | <b>C)</b> (Neutro)<br><i>(Neutral)</i><br>(Neutre)<br><i>(Neutro)</i><br>(Neutral)<br>(Nulleider) | <b>E)</b> (Fase)<br><i>(Step)</i><br>(Phase)<br><i>(Fase)</i><br>(Phase)<br>(fase)                 | <b>G)</b> Rete 230V~<br><i>Mains 230V~</i><br>Secteur 230V~<br><i>Red 230V~</i><br>Netz 230V~<br>Netvoeding 230V~ |
| <b>B)</b> Filtro<br><i>Filter</i><br>Filtre<br><i>Filtro</i><br>Filter<br>Filter                      | <b>D)</b> Terra<br><i>Earth</i><br>Masse<br><i>Tierra</i><br>Erdung<br>Aarding                    | <b>F)</b> Utilizzatore<br><i>Utility</i><br>Utilisateur<br><i>Usuario</i><br>Benutzer<br>Gebruiker | <b>H)</b> Linea~<br><i>Line~</i><br>Ligne~<br><i>Línea~</i><br>Leitung~<br>Lijn~                                  |

Per le informazioni sulla configurazione e l'utilizzo del kit scaricare il Libretto di configurazione e il Libretto d'uso scansionando il QR Code riportato di seguito.



<http://qrcode.urmet.com/default.aspx?prodUrmet=156800&lingua=it>

*Download the installation and configuration booklet by scanning the QR Code below for information on how to configure and use the kit.*

*Pour plus d'informations, télécharger la Notice de configuration et la Notice d'utilisation du kit, en lisant le code QR ci-après.*

*Para la información sobre la configuración y el uso del kit, descargar el Manual de configuración y el Manual de uso escaneando el Código QR reproducido a continuación.*

*Für Informationen zur Konfiguration und Verwendung des Kits die Konfigurationsanleitung und die Bedienungsanleitung durch Einscannen des nachstehenden QR-Codes herunterladen.*

*Voor de informatie over de configuratie en het gebruik van de kit downloadt u de Instructies voor de configuratie en de Gebruiksaanwijzing met behulp van de hierna afgebeelde QR Code.*



<http://qrcode.urmet.com/default.aspx?prodUrmet=156800&lingua=en>



## ITALIANO

### **DIRETTIVA 2012/19/UE DEL PARLAMENTO EUROPEO E DEL CONSIGLIO del 4 luglio 2012 sui rifiuti di apparecchiature elettriche ed elettroniche (RAEE)**

Il simbolo del cassonetto barrato riportato sull'apparecchiatura o sulla sua confezione indica che il prodotto alla fine della propria vita utile deve essere raccolto separatamente dagli altri rifiuti.

L'utente dovrà, pertanto, conferire l'apparecchiatura giunta a fine vita agli idonei centri comunali di raccolta differenziata dei rifiuti elettrotecnici ed elettronici.

In alternativa alla gestione autonoma è possibile consegnare l'apparecchiatura che si desidera smaltire al rivenditore, al momento dell'acquisto di una nuova apparecchiatura di tipo equivalente.

Presso i rivenditori di prodotti elettronici con superficie di vendita di almeno 400 m<sup>2</sup> è inoltre possibile consegnare gratuitamente, senza obbligo di acquisto, i prodotti elettronici da smaltire con dimensione massima inferiore a 25 cm.

L'adeguata raccolta differenziata per l'avvio successivo dell'apparecchiatura dismessa al riciclaggio, al trattamento e allo smaltimento ambientalmente compatibile contribuisce ad evitare possibili effetti negativi sull'ambiente e sulla salute e favorisce il reimpiego e/o riciclo dei materiali di cui è composta l'apparecchiatura.



## ENGLISH

### **DIRECTIVE 2012/19/EU OF THE EUROPEAN PARLIAMENT AND OF THE COUNCIL of 4 July 2012 on waste electrical and electronic equipment (WEEE)**

The symbol of the crossed-out wheeled bin on the product or on its packaging indicates that this product must not be disposed of with your other household waste.

Instead, it is your responsibility to dispose of your waste equipment by handing it over to a designated collection point for the recycling of waste electrical and electronic equipment.

The separate collection and recycling of your waste equipment at the time of disposal will help to conserve natural resources and ensure that it is recycled in a manner that protects human health and the environment.

For more information about where you can drop off your waste equipment for recycling, please contact your local city office, your household waste disposal service or the shop where you purchased the product.



## FRANÇAIS

### **DIRECTIVE EUROPEENNE 2012/19/UE DU 4 JUILLET 2012 RELATIF AUX DÉCHETS D'ÉQUIPEMENTS ÉLECTRIQUES ET ÉLECTRONIQUES (DEEE)**

Le symbole de la poubelle sur roues barrée d'une croix présent sur le produit ou sur son emballage indique que ce produit ne doit pas être éliminé avec vos autres déchets ménagers.

Au lieu de cela, il est de votre responsabilité de vous débarrasser de vos équipements usagés en les remettant à un point de collecte spécialisé pour le recyclage des déchets des équipements électriques et électroniques (DEEE). La collecte et le recyclage séparés de vos équipements usagés au moment de leur mise au rebut aidera à conserver les ressources naturelles et à assurer qu'elles sont recyclées d'une manière qui protège la santé humaine et l'environnement. Pour plus d'informations sur les lieux de collecte où vous pouvez déposer vos équipements usagés pour le recyclage, veuillez contacter votre revendeur, votre service local d'élimination des ordures ménagères.



## ESPAÑOL

### **DIRECTIVA 2012/19/UE DEL PARLAMENTO EUROPEO Y DEL CONSEJO DEL 4 DE JULIO DE 2012 SOBRE RESIDUOS DE APARATOS ELÉCTRICOS Y ELECTRÓNICOS (RAEE)**

El símbolo del contenedor de basura tachado con un aspa en el producto, o en su embalaje, indica que dicho producto no debe desecharse junto con los otros residuos domésticos.

Por el contrario, es responsabilidad del usuario desechar el equipo entregándolo a un punto de recogida designado para el reciclaje de residuos de equipos eléctricos y electrónicos.

La recogida separada y el reciclaje de estos residuos en el momento de su eliminación ayudarán a conservar los recursos naturales y garantizarán que se reciclen de manera adecuada para proteger la salud y el medio ambiente.

Si desea información adicional sobre los lugares donde puede dejar estos residuos para su reciclado, consulte con las autoridades locales, con sus servicios de recogida de residuos o material reciclable o con la tienda donde adquirió el producto.



## DEUTSCH

### **RICHTLINIE 2012/19/EU DES EUROPÄISCHEN PARLAMENTS UND DES RATES VOM 4. JULI 2012 ÜBER ELEKTRO- UND ELEKTRONIK-ALTGERÄTE (WEEE)**

Das Symbol der durchgestrichenen Abfalltonne auf Rädern auf dem Produkt oder dessen Verpackung gibt an, dass das Produkt nicht zusammen mit dem Hausmüll entsorgt werden darf.

Es liegt daher in Ihrer Verantwortung, Ihre Altgeräte zu entsorgen, indem Sie diese bei einer geeigneten Sammelstelle für das Recycling für Elektro- und Elektronik-Altgeräte abgeben.

Die getrennte Sammlung und das Recycling Ihrer Altgeräte bei der Entsorgung tragen zur Erhaltung natürlicher Ressourcen bei und garantieren, dass diese auf gesundheits- und umweltverträgliche Weise recycelt werden.

Weitere Informationen dazu, wo Sie Ihre Altgeräte zum Recycling abgeben können, erhalten Sie bei Ihrer Gemeindeverwaltung, Ihrem Hausmüll-Entsorgungsdienst oder bei dem Händler, bei dem Sie das Produkt gekauft haben.



## VLAAMS

### **RICHTLIJN 2012/19/EU VAN HET EUROPEES PARLEMENT EN DE RAAD VAN 4 JULI 2012 BETREFFENDE AFGEDANKTE ELEKTRISCHE EN ELEKTRONISCHE APPARATUUR (AEEA)**

Het symbool van een doorgekruiste verrijdbare afvalbak op het product of op de verpakking ervan betekent dat dit product niet samen met ander stedelijk afval mag worden verwijderd. Het is uw taak om het afval van dit materiaal naar een erkend afvalinzamelpunt te brengen voor het recyclen van afgedankte elektrische en elektronische apparatuur.

Door dit materiaal te sorteren en te recyclen wanneer u het afdankt, draagt u bij tot het behoud van de natuurlijke hulpbronnen en garandeert u dat het gerecycled wordt op een manier die de gezondheid en het milieu beschermt.

Voor meer informatie over waar u het afval van dit materiaal kunt overhandigen voor recycling neemt u contact op met het stadsbestuur, de plaatselijke afvaldienst of de winkel waar u het product heeft gekocht.

**DS 1723-050A**

URMET S.p.A.  
10154 TORINO (ITALY)  
VIA BOLOGNA 188/C  
Telef. +39 011.24.00.000 (RIC. AUT.)  
Fax +39 011.24.00.300 - 323

**urmet**

**LBT 20864**

Area tecnica  
servizio clienti +39 011.23.39.810  
<http://www.urmet.com>  
e-mail: [info@urmet.com](mailto:info@urmet.com)

MADE IN CHINA