

**ONE- AND TWO-FAMILY 2-WIRE KIT WITH CALL FORWARDING  
FUNCTION**

**Ref. 1723/95 - 1723/96 (\*)**

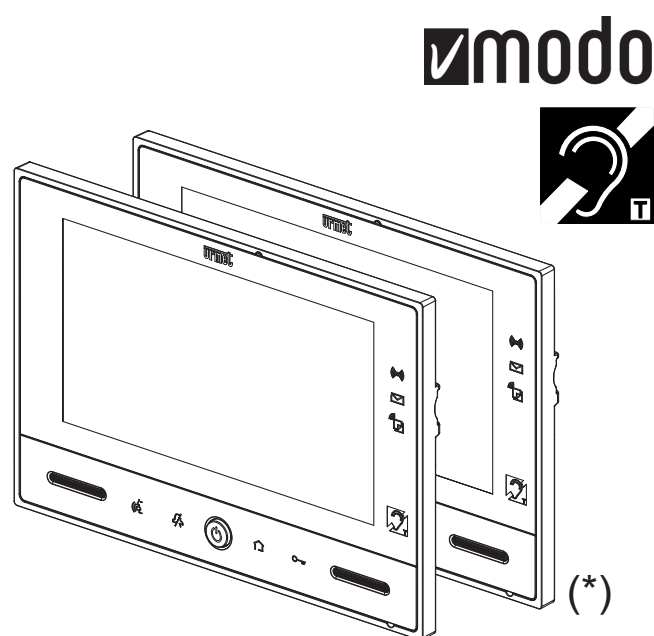
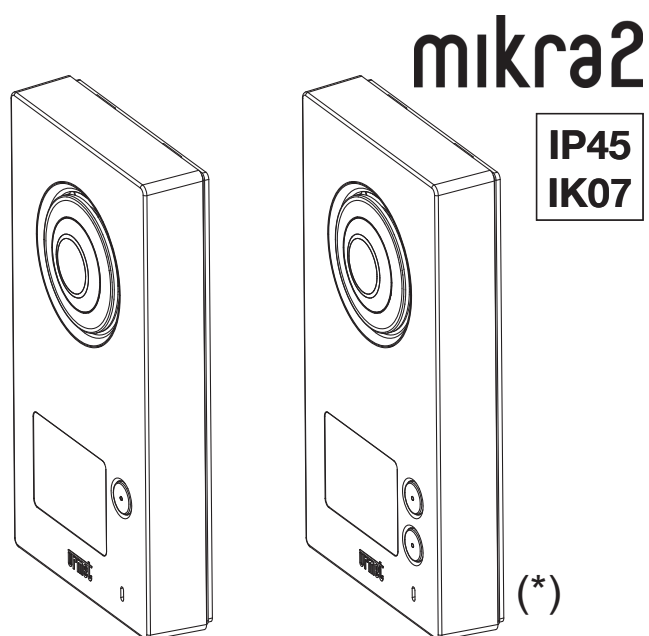

**USAGE BOOKLET**

## TABLE OF CONTENTS

---

<a href="#">HOW TO TURN ON THE SCREEN AND ACCESS THE VARIOUS FUNCTION</a>	3
<a href="#">RECEIVING A VIDEO DOOR PHONE CALL FROM OUTSIDE</a>	3
<a href="#">INTERCOM CALL</a>	5
<a href="#">CONTROLLING THE CAMERA</a>	7
<a href="#">VIDEO DOOR PHONE ANSWERING SERVICE</a>	8
<a href="#">VIDEO DOOR PHONE ANSWERING DEVICE ACTIVATION</a>	8
<a href="#">MESSAGE TO THE VISITOR</a>	8
<a href="#">RECORDING THE MESSAGE</a>	8
<a href="#">ACTIVATING THE MESSAGE</a>	9
<a href="#">VIDEOCLIP CONSULTATION</a>	10
<a href="#">SAVING VIDEOCLIPS</a>	10
<a href="#">DELETING VIDEOCLIPS</a>	12
<a href="#">ACTIVATING HOME AUTOMATION COMMANDS</a>	13
<a href="#">AUDIO POST-IT</a>	15
<a href="#">RECORDING MESSAGES</a>	15
<a href="#">LISTENING TO MESSAGES</a>	16
<a href="#">DELETING MESSAGES</a>	16
<a href="#">AUTOMATIC DOOR OPENER</a>	17
<a href="#">ALARMS</a>	17
<a href="#">ARMING</a>	17
<a href="#">ALARM</a>	18
<a href="#">SIGNALLING THE ALARM HAVING BEEN ACTIVATED (ALARM MEMORY)</a>	19
<a href="#">DEACTIVATION</a>	19
<a href="#">CONSULTING THE ALARM LOG MENU</a>	19
<a href="#">SAVING THE ALARM LOG MENU</a>	20
<a href="#">DELETING THE ALARM LOG</a>	21
<a href="#">DOOR OPENING LOG</a>	22
<a href="#">CALL FORWARDING TO SMARTPHONES AND TABLETS</a>	22
<a href="#">ACTIVATION</a>	23
<a href="#">CALL FORWARDING FUNCTION STATUS ICON</a>	25
<a href="#">DEACTIVATION</a>	26
<a href="#">CALLME APP USER MANUAL</a>	27
<a href="#">CLEANING THE SCREEN</a>	27
<a href="#">USING THE THERMOSTAT</a>	28
<a href="#">PUSH TO TALK (PTT) MODE</a>	29
<a href="#">LETTERBOX FUNCTION</a>	29
<a href="#">CHANGING THE VIDEO DOOR PHONE SETTINGS</a>	29
<a href="#">AUDIO SETTINGS</a>	30
<a href="#">SELECTING THE MELODIES</a>	31
<a href="#">BACK-LIGHTING</a>	33
<a href="#">DATE AND TIME</a>	33
<a href="#">INTERCOM: SETTING THE VIDEO DOOR PHONE NAMES</a>	34
<a href="#">ACCESS CONTROL</a>	34
<a href="#">KEY MEMORISATION PROCEDURE</a>	34
<a href="#">KEY CANCELLATION PROCEDURE</a>	35

## HOW TO TURN ON THE SCREEN AND ACCESS THE VARIOUS FUNCTION

- Touch anywhere on the screen or
- Press the  button at the bottom centre of the video door phone.

To turn off the screen, press the  button of the video door phone or wait for the 60 second timeout.

## RECEIVING A VIDEO DOOR PHONE CALL FROM OUTSIDE

Forward a video door phone call by pressing the call button:

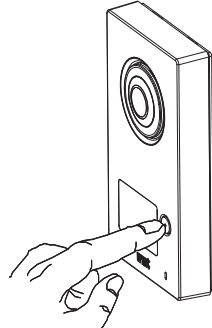



**WARNING.** The system status signal led (DDA) are present only on the push button panel of the single-family kit Ref. 1723/95.

The  icon lights up to indicate that the call has been forwarded.



The following will appear on the video door phones in the system:





Even without answering, it is possible to open the door by using either:



- The  button, illuminated with a green light for easy accessibility.
- The  button.

In correspondence to the door opening, the  icon will light up on the panel.

It is also possible to turn on the stairway or garden light, using the  button, open the garage gate using the  button, or even refuse the call by using the  button.

To answer, touch either:

- The  button at the bottom, illuminated in red.
- The  button.

Upon the response, the  button will become green, and on the panel the  icon will light up to invite the visitor to speak.

To end the conversation, touch either:

– The green  button.

– The  button.

Following a call (before starting a conversation or during the conversation), it is also possible:

- To modify the image from 4:3 to 16:9 or vice-versa.
- To do so, touch the  icon; the 16:9 format is selected and the camera frames the upper part of the scene.

It is possible to shift the frame by scrolling the image with your finger:

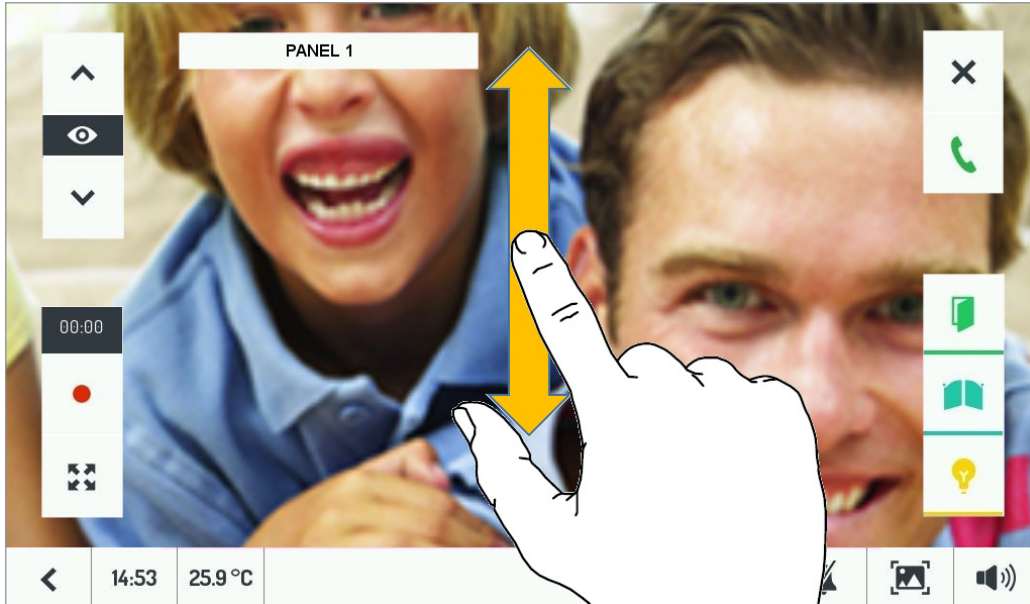

 The image format being used is memorised at the end of the call. Then later calls will display the video in the last format selected.

- Click on the other cameras present in the system, using the arrows to the side  .

 To answer it is however necessary to return to the panel camera.

- Record a videoclip of the visitor by touching the record button  .

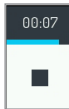
Once the recording starts, the button becomes  .

The counter indicates the progress of the recording. The recording can be ended by touching the button again or because the end of the maximum recording time has been reached.

- Regulate the video in terms of: luminosity, contrast, and saturation, by touching the icon  .

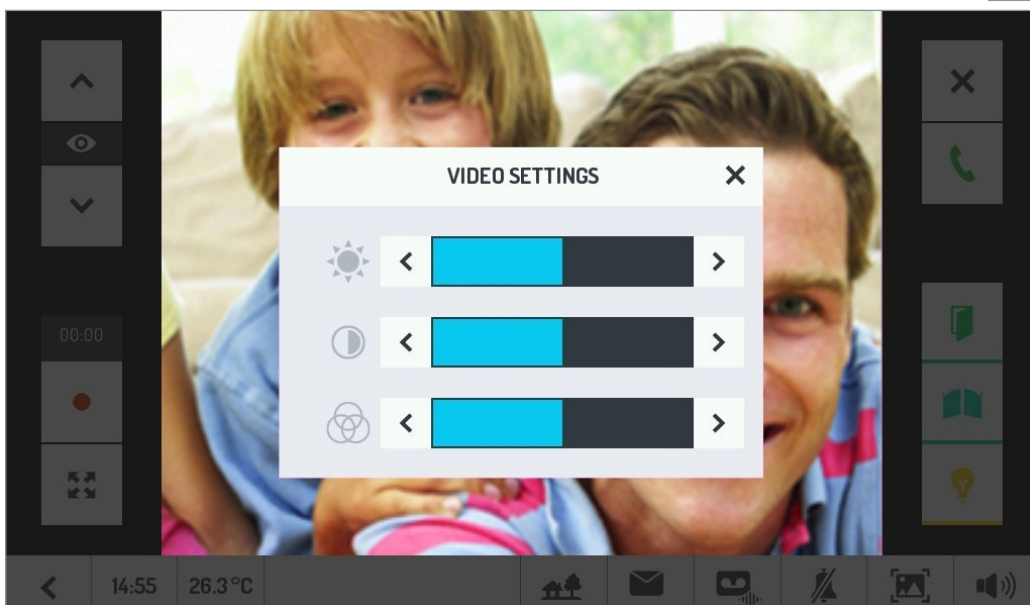

- Regulate the sound intensity of the speaker by touching the icon  . (If the user wishes to enable or disable the feedback 'click' of the touchscreen).

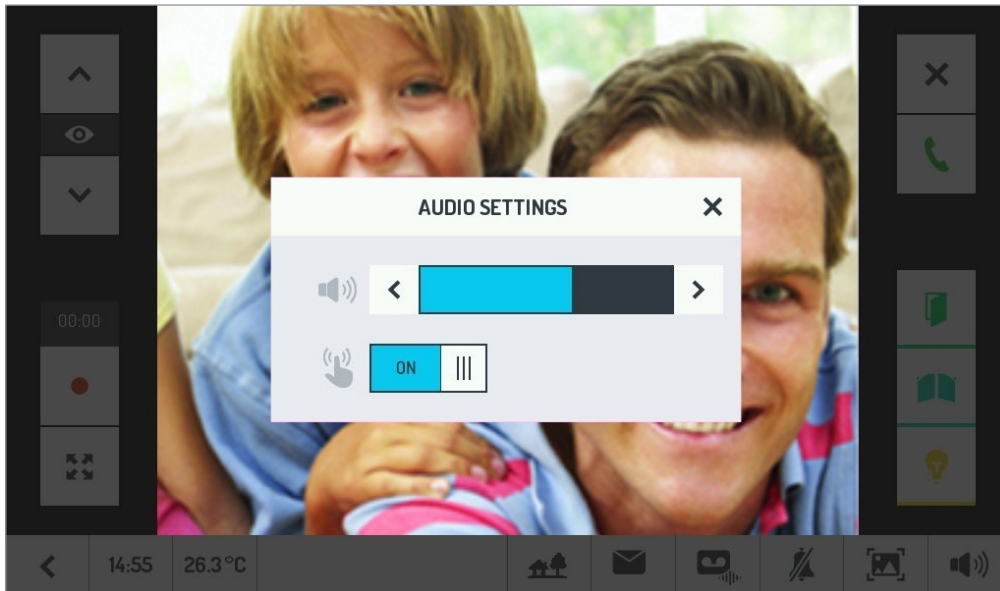

Finally, during the conversation, it is possible to enable or disable the microphone to prevent the visitor from listening by touching the  button.

## INTERCOM CALL

From each video door phone it is possible to call:

- One of the other video door phones present in the installation.
- All the other video door phones.
- All the video door phones of adjacent apartment in case of two-family installation.

*If on the master video door phone unit Ref. 1723/98, the call forwarding function has been configured and activated, in addition to the video door phones, the smartphones on which the CallMe App has been installed also ring.*

The installer must attribute suitable names to the devices that can be called.

This operation must be carried out on each video door phone present in the installation. See the chapter *INTERCOM: SETTING THE VIDEO DOOR PHONE NAMES*.

To forward an intercom call, turn on the screen and then touch the

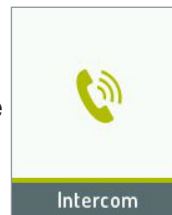

icon .

The following window will appear:

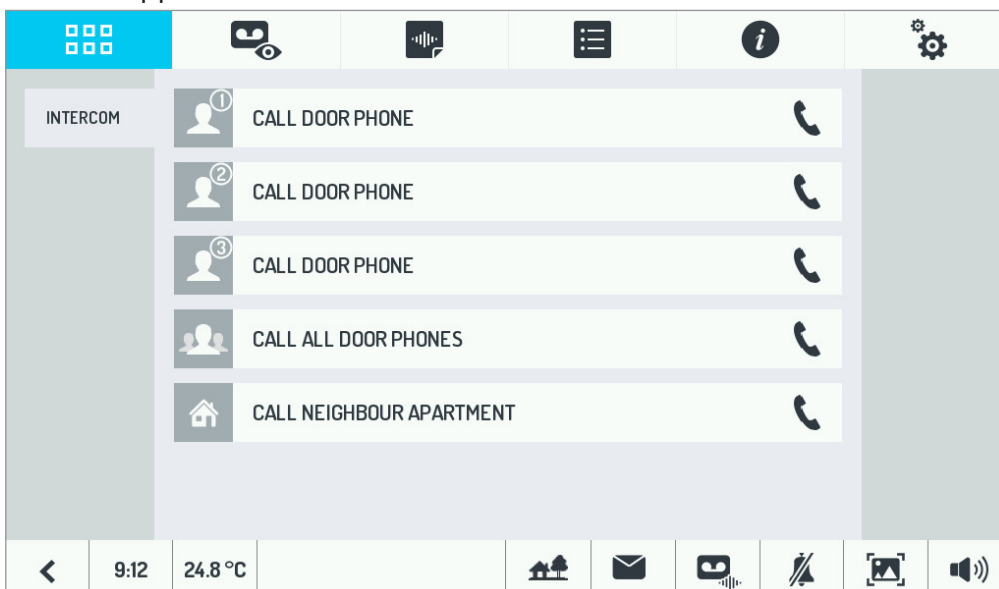

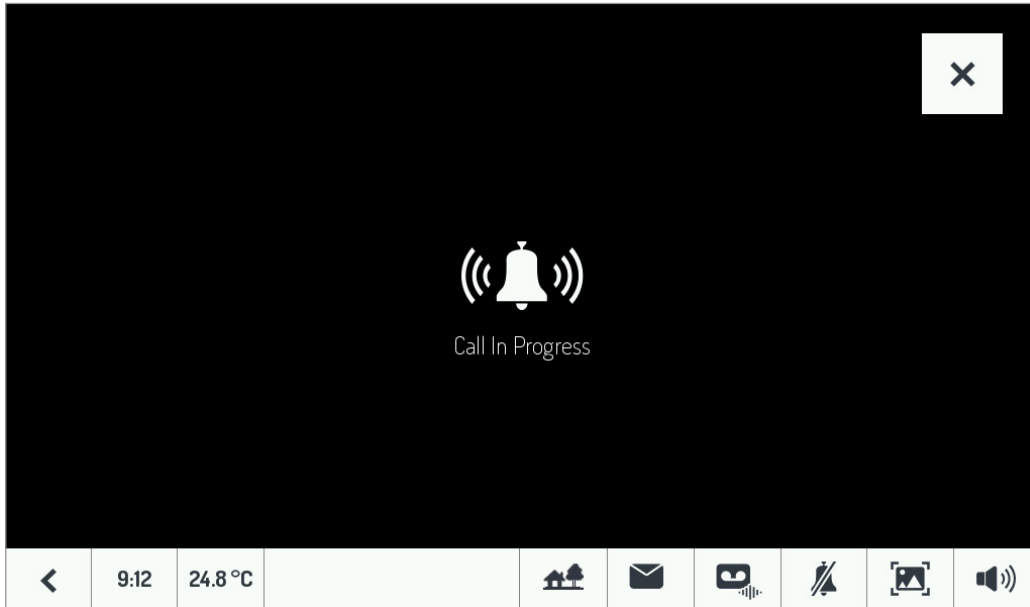

Select the video door phone to call by touching the corresponding line.  
The following page will appear on the video door phone making the call:

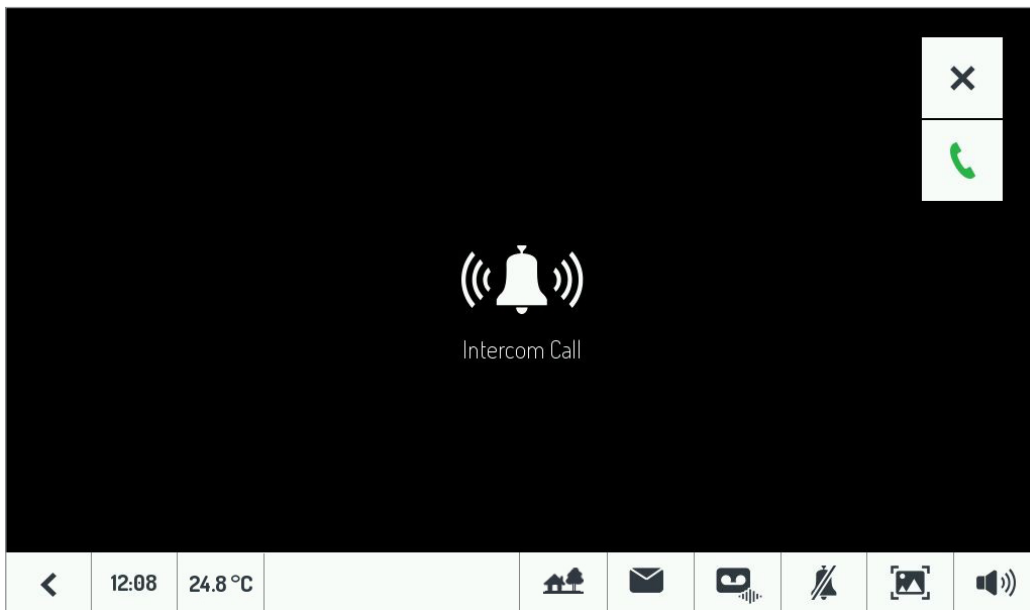

The video door phone called rings and presents the following page for a maximum of 60 seconds; then the system returns to stand-by.





Either one the users can terminate the call at any time by touching the  button.

The user called must press the  icon to be able to begin the conversation with the caller.

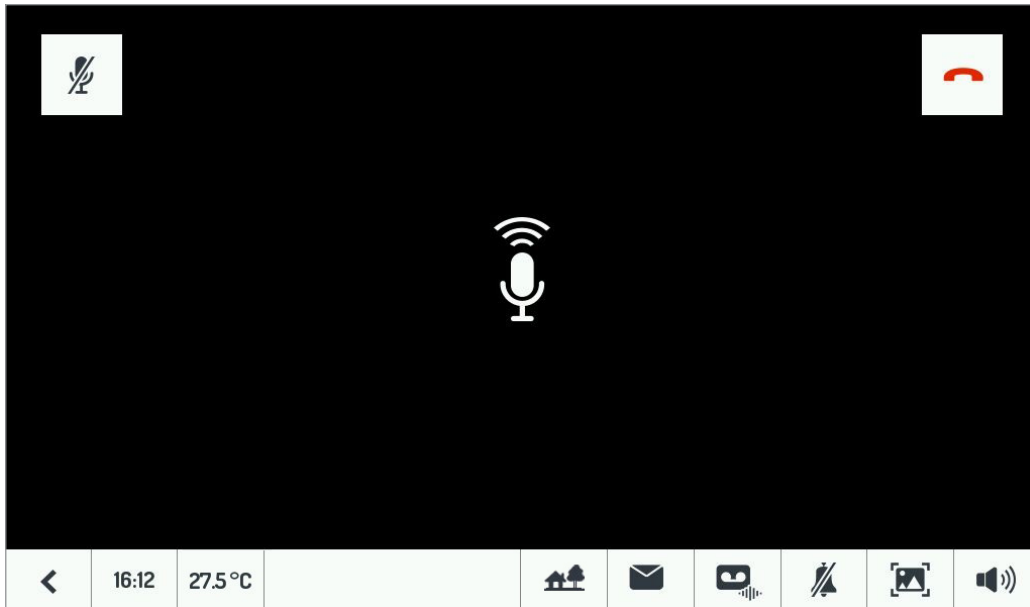
After answering, the page on both video door phones changes as follows:



Both users can:

-  exclude or reactivate the microphone of his/her own video door phone to prevent the other from hearing what is said.
-  end the conversation.

## CONTROLLING THE CAMERA

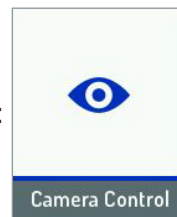

Turn on the video door phone and touch the control camera button:



The video door phone will present the image taken by the panel camera, also offering the possibility to open the door or start a conversation:



Use the two arrows at the top left to follow the cycle of all the cameras present.

Whenever a cycle time has been defined, the  icon will have a light blue background: .

In this case, once the programmed cycle time has passed, the image of the next camera will appear automatically.

The user can enable or disable the cycle display at any time by touching the  icon.

By touching the  icon it is possible to start the recording of a videoclip.

If the cyclic transition between cameras is enabled, the recording of the videoclip is considered a priority. Therefore the passage to the next camera will take place only at the end of the recording of the videoclip, therefore guaranteeing the user the possibility to make a full recording of what he/she desires.

## VIDEO DOOR PHONE ANSWERING SERVICE

This function makes it possible to automatically record a videoclip following a call.

The action is slightly different, depending on where a message to the visitor has been enabled or not (see the paragraph MESSAGE TO THE VISITOR).

- If the message to the visitor was not enabled, the videoclip will be only video.
- If the message to the visitor was enabled, the videoclip will be both audio and video, and will begin at the end of the message and of the successive beep (if present).

The duration of the videoclip is that one set on the system by the installer.

## VIDEO DOOR PHONE ANSWERING DEVICE ACTIVATION

Turn on the video door phone and activate the function by first touching the  icon and then the  button.



The following button  will be displayed..

The LED  will turn green to indicate that the function has been enabled.

Following a call, the videoclip will be recorded for the set duration or until the users responds.

If the user responds, he/she will be able to record another videoclip during the conversation.

The presence of new videoclips in the memory is signalled to the user by the LED  when it flashes green.

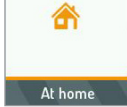
 To disable the video door phone answering service, press the  button. Button  will be displayed to indicate that the function has been disabled.

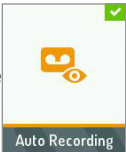
**IMPORTANT** If the call forwarding function has been enabled on the video door phone, press the 

button to deactivate the video door phone answering service function and to activate the call

forwarding function  (see the CALL FORWARDING TO SMARTPHONES AND

TABLETS chapter).

## MESSAGE TO THE VISITOR

The panel may transmit an audio message following a call.

The options also allow the audio message to be followed by a 'beep' that invites the visitor to leave a message.

This function is useful for:

- Improving the clients' welcome, making reference to the name of the company and to a welcome message like: 'Welcome to xxx Company...'
- Providing preliminary instructions to the client, like 'Please enter and be seated in the waiting room'.
- Providing information concerning opening hours: 'Our offices are open from... to...'



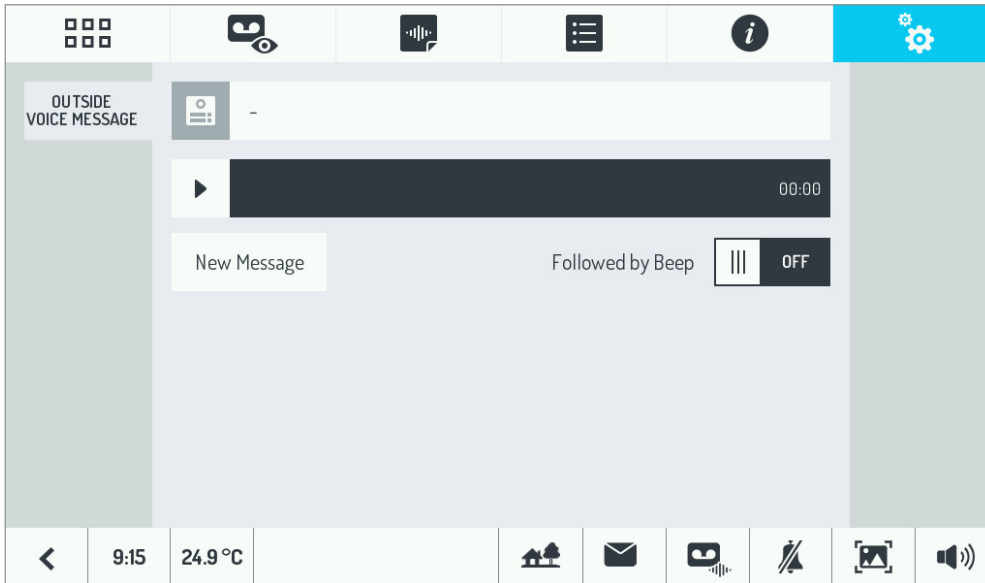

## RECORDING THE MESSAGE

From the 'Configuration' menu, accessible from the  icon to the top right, select, in the 'User' menu, the item 'Outside Voice Message':

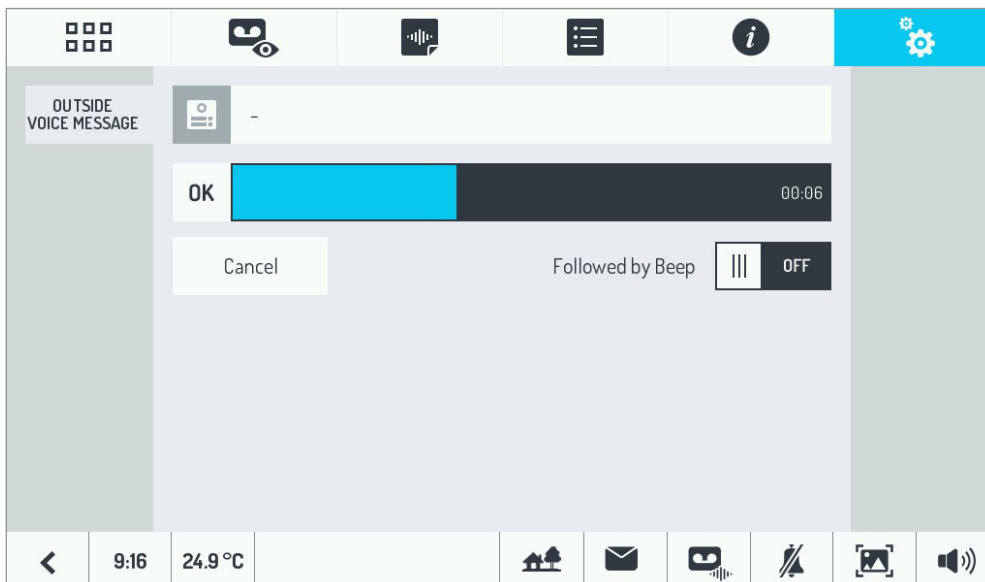

Touch 'New Message', the  button changes into . Touch it and record the message.



The maximum length of a message is 20 seconds. The recording may be interrupted sooner by touching the  icon.

It is also possible to have the message followed by a 'beep' (to invite the visitor to leave a message).

## ACTIVATING THE MESSAGE

Turn on the video door phone and activate the function by touching the relative button .

A check-mark will appear next to the button .

 If a message has not been recorded for the visitors, pressing the  key will have no effect.

When the visitor makes a call, the message will be reproduced on the panel followed by a beep, if so configured. If the phone answering device is also enabled<sup>(1)</sup>, at the end of the message (and a potential beep), and audio and videoclip of the visitor will be recorded.

 To disable the reproduction of the message, proceed in the same way as for the activation.

(1) Both functions, the reproduction of the message to the visitor and the phone answering device, can also be activated separately. In this way the user has the utmost flexibility in using these functions.



## VIDEOCLIP CONSULTATION

All the videoclips recorded (automatically in case of alarms or the phone answering device, or manually in case of recording during a call) are listed in the videoclip section, which can be accessed by pressing the  button. The number next to the icon indicates the videoclips that have not yet been seen<sup>(2)</sup>.

The recordings to still be seen are highlighted in green, while those already seen are in black.

It is sufficient to touch the name of a videoclip to watch it.



The icon on the left facilitates the type of recording:  indicates a videoclip saved in case of an alarm,  indicates a videoclip recorded by an external door unit via the video door phone answering device or manually during a call, the  icon indicates a videoclip recorded by an additional camera.

The name of the videoclip always includes:

- Number of the camera by which it was recorded (from 1 to 6).
- Name of the camera (which can be personalised during installation).
- Date.
- Time.
- Suffix ‘\_AL’ in case of recording following an alarm.

## SAVING VIDEOCLIPS

If a videoclip should be of particular interest, it is possible to download it from the video door phone using a microSD card.

Turn off the master video door phone display using the central button and insert a microSD card<sup>(3)</sup>:

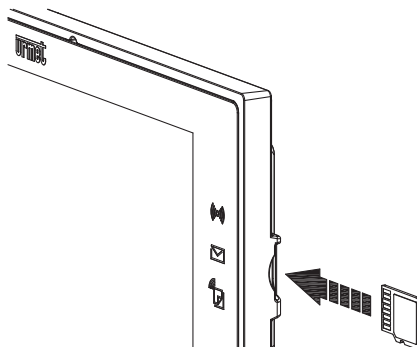

<sup>(2)</sup> The number is not specific only for the Alarm videoclips, but for all the videoclips recorded automatically (alarms, phone answering device).

<sup>(3)</sup> Use a standard microSD card and not a microSDHC.

Turn the video door phone on again and touch the  icon to access the videoclip menu.

On the right a new icon will now appear to indicate the presence of the microSD card:

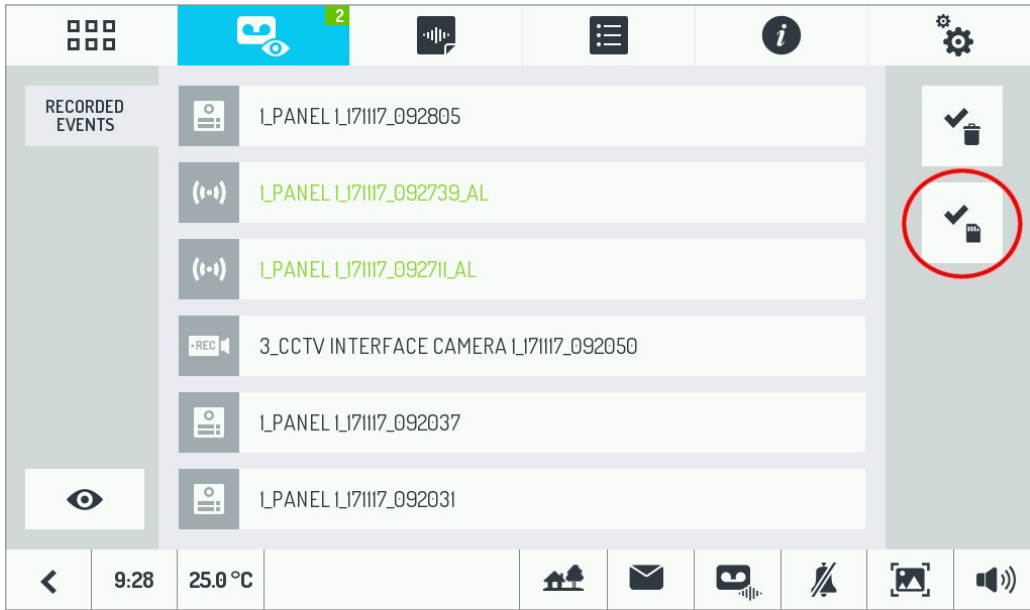

Touch this icon to select which videoclip you wish to save:



Then touch the icon with the symbol of the microSD card to the top right: saving will be started. While saving the file, the icon will turn blue.

**IMPORTANT: DO NOT EXPEL THE microSD CARD WHILE THE ICON IS BLUE.**

When saving is complete, the icon will turn black on a white background: it is then possible to expel the microSD card.

All the videoclips will be saved in a folder of the microSD card called 'VIDEOCLIPS'. If this folder does not exist, it is created automatically before saving the videoclip.

The files saved are in .avi format and can be visualised on a PC using a suitable player.

# DELETING VIDEOCLIPS

Turn the video door phone on again and touch the  icon to access the videoclips menu.

When the  icon next to each videoclips is touched, a square will appear.

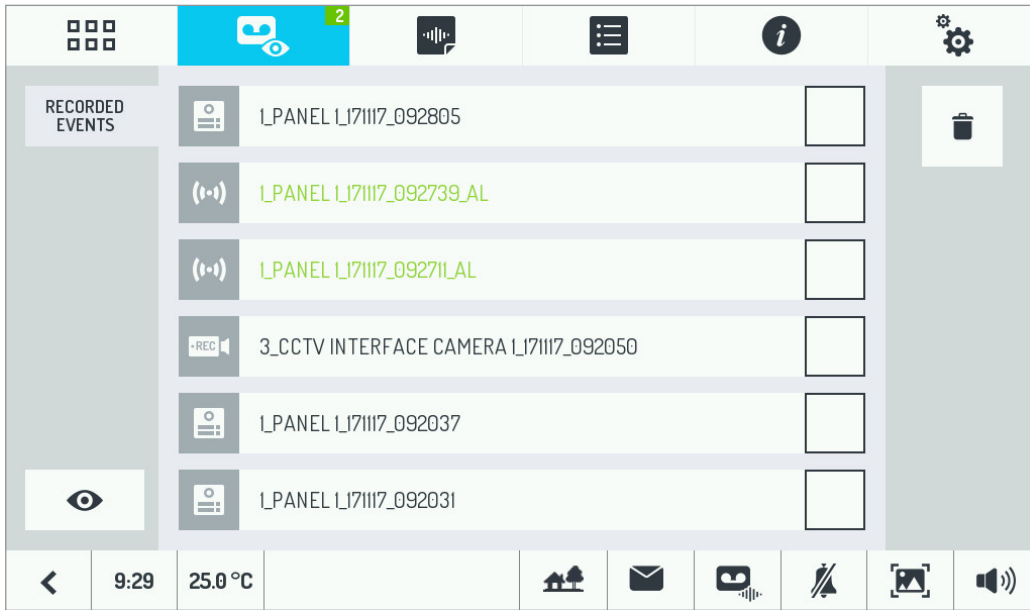

For each videoclips to be deleted, touch the relative square and a check mark will appear.



Select the  button to eliminate all the videoclips marked with a check mark.

# ACTIVATING HOME AUTOMATION COMMANDS

From the Home Page press the button

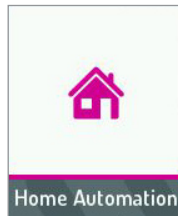

to access Yokis Home Automation:

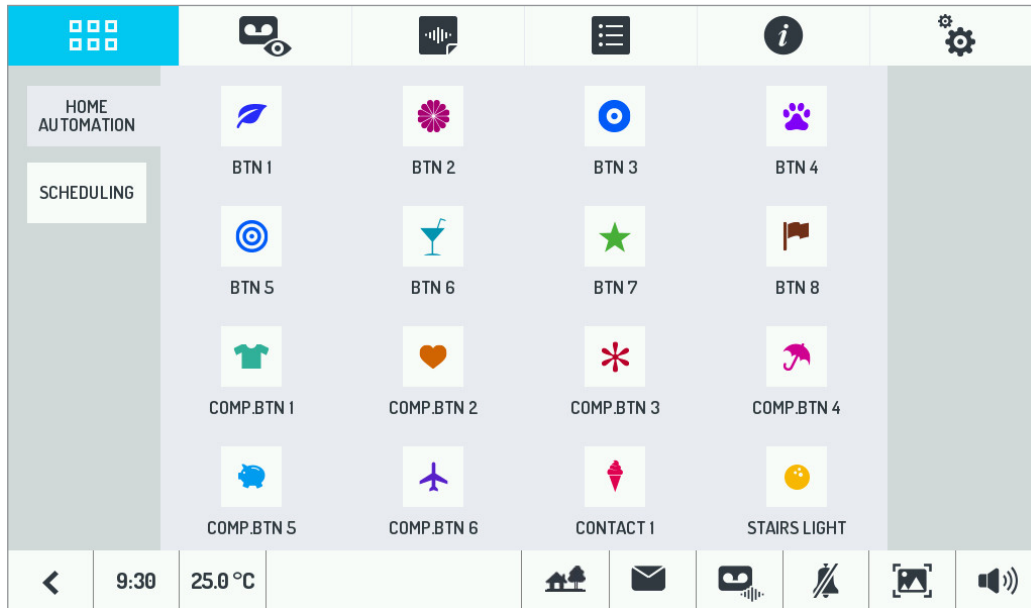

From here select the command or commands desired.

To schedule a command in one or more weekly events, go to the home automation page of the video door phone,

press **SCHEDULING**, and then .

The following page will appear:

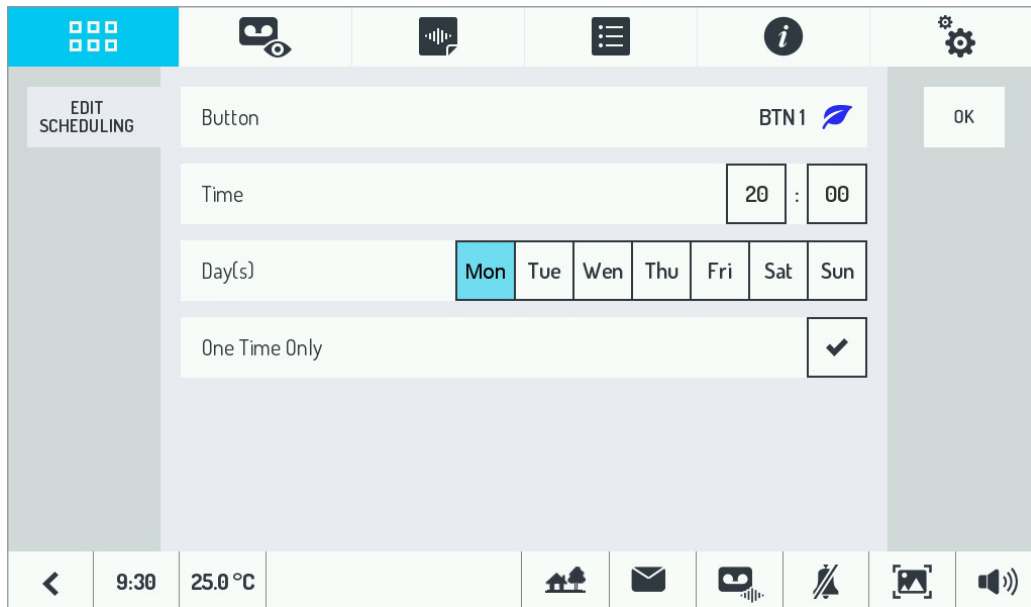



Insert the time and days the programme should be executed. If the 'One Time Only' option is enabled, the programme will be executed just once and will then be disabled. If instead this option is not enabled, the scheduling will be repeated every week on the days set.

Touch 'Button' to change the button to be scheduled, insert the time and days of the week when the programme should be executed, and if it should be executed just one time. Save the settings by touching **OK**.

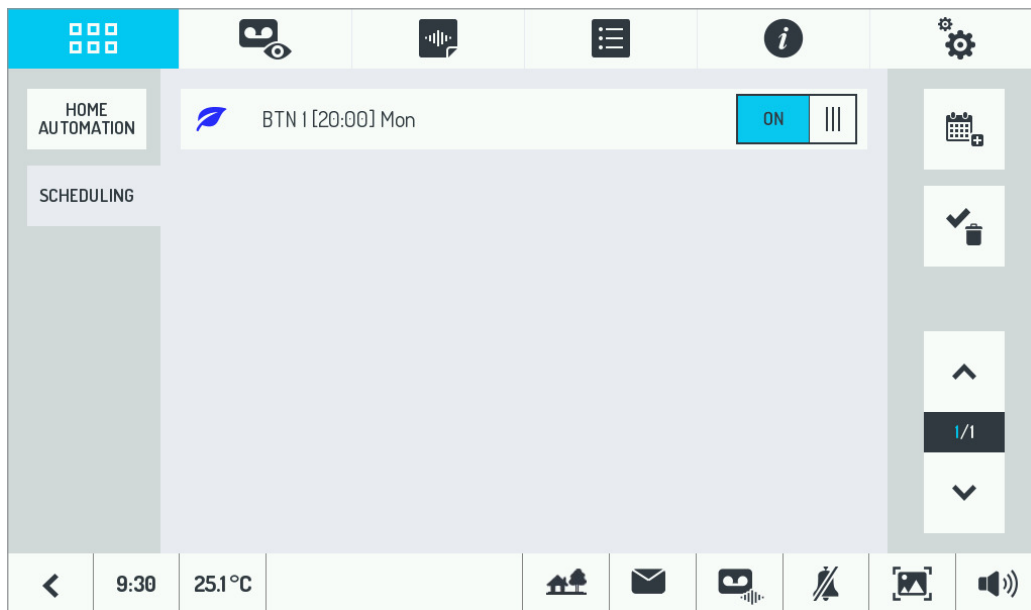
This will return to the previous page. From here it is possible to enable or disable a previously configured schedule.



To change a schedule, it is sufficient to select it and proceed in the same manner as when it was created.

To cancel a schedule, touch the  picture, add a check mark next to the scheduled programme to be deleted by touching the square and, finally, touch  to confirm the deletion.

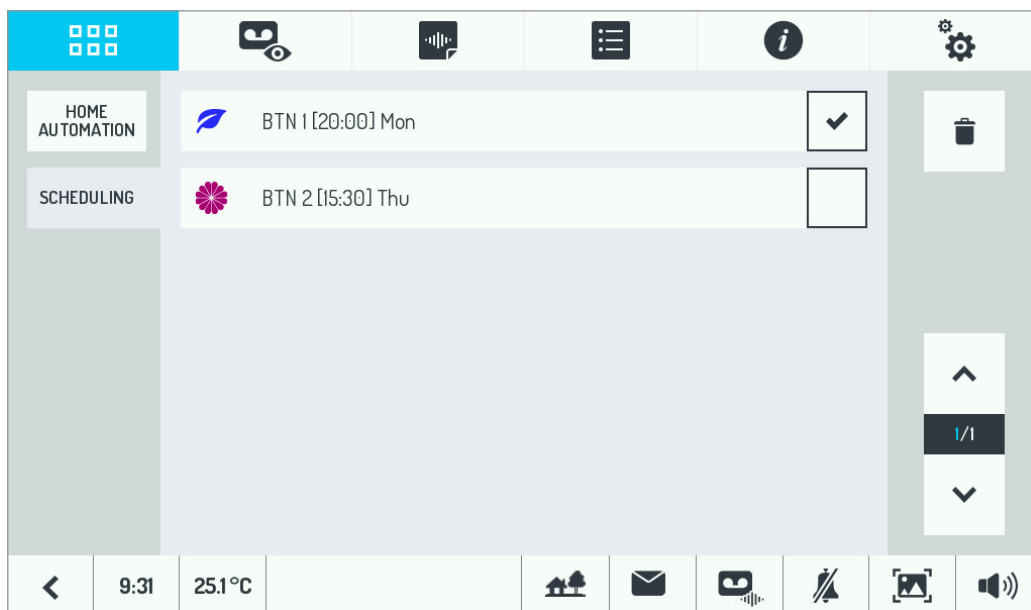

# AUDIO POST-IT

This function makes it possible to record brief audio messages on the video door phone that can later be listened to by people returning home or to the office.

## RECORDING MESSAGES

Turn on the video door phone, then access the audio POST-IT page using the



or

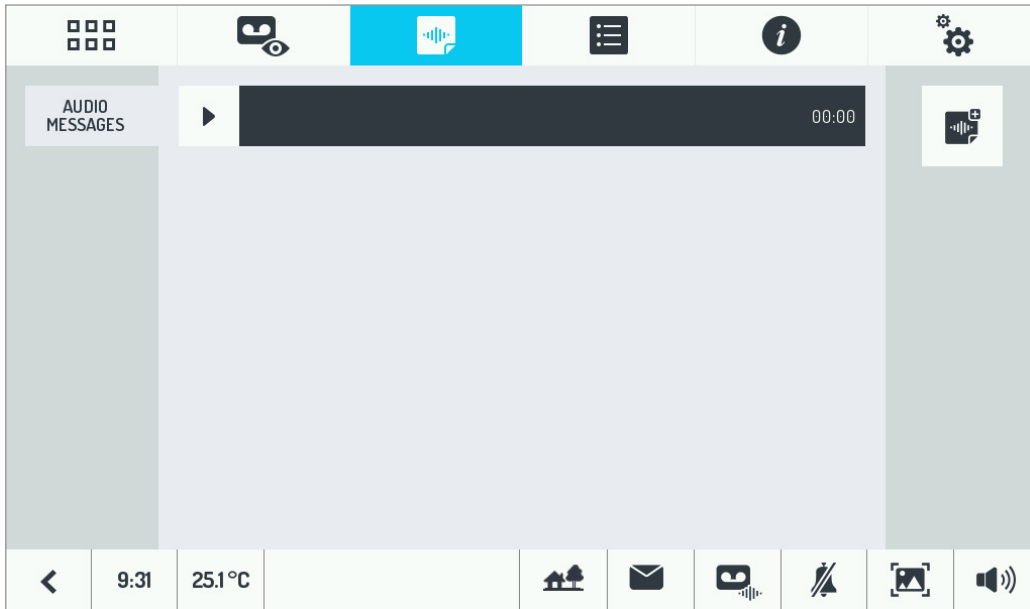

Touch the icon , to change the button in . Touch it and record the message, remembering that the maximum duration is 20 seconds.

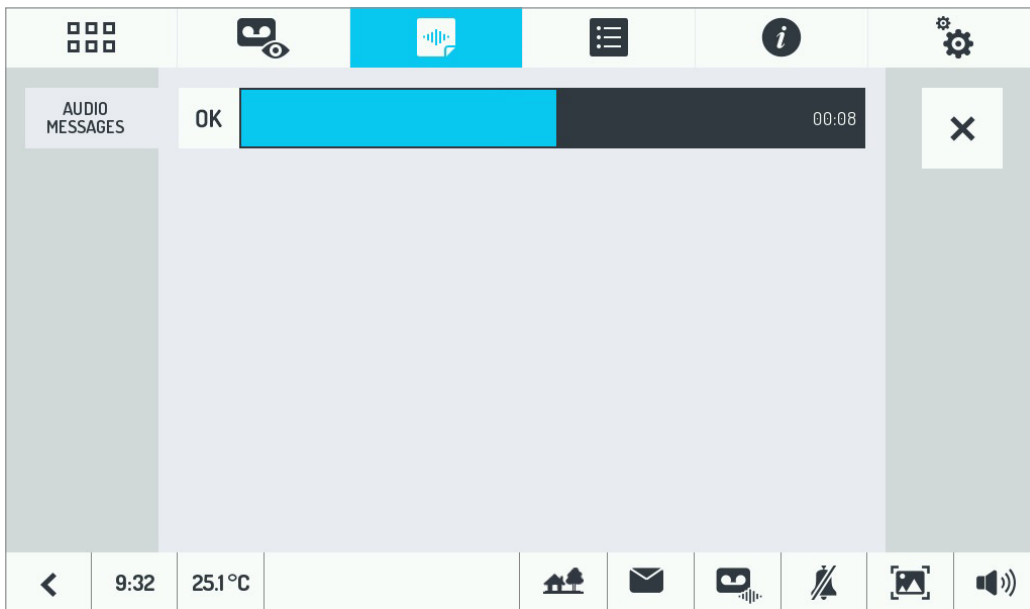

The recording may be interrupted sooner by touching the icon.

The LED will flash red and indicate that there is a new message.

## LISTENING TO MESSAGES

The  icon indicates the number of the audio POST-ITs not yet listened to.

When touched, the list of messages appears:

- new messages in green
- messages already listened to in black.

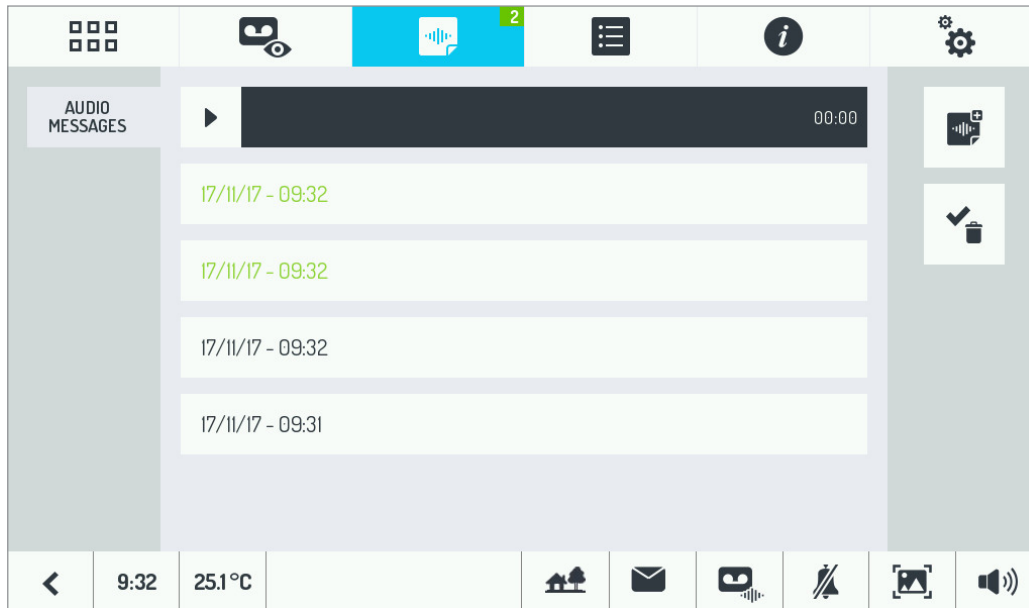

Just touch one of the messages in the list and then the play  icon to listen to it.

## DELETING MESSAGES

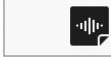
Turn on the video door phone, then access the audio POST-IT page using the  or

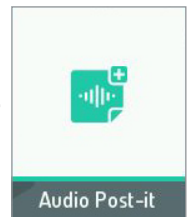

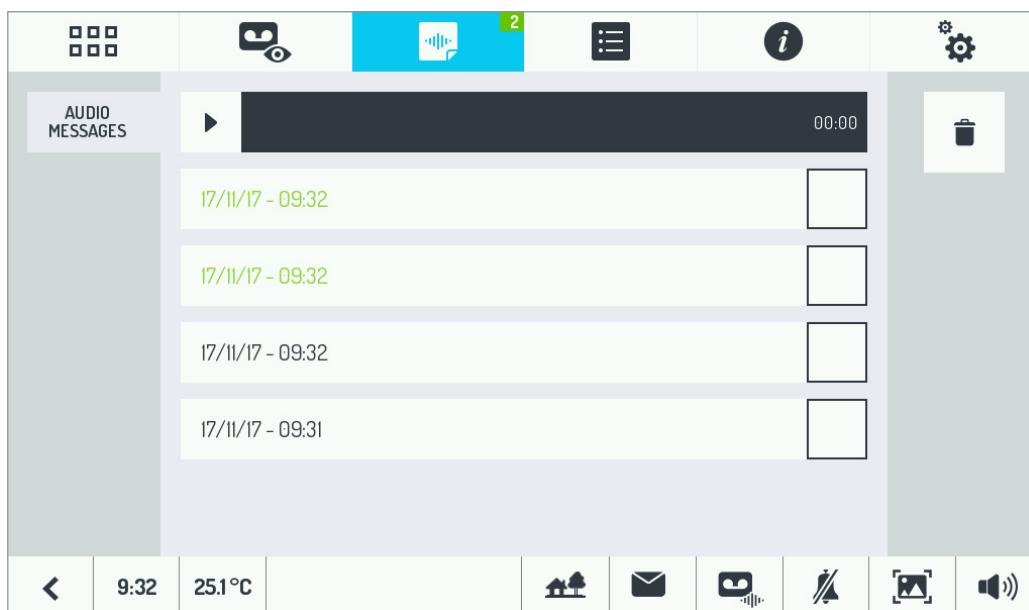

When the  icon next to each videoclip is touched, a square will appear.



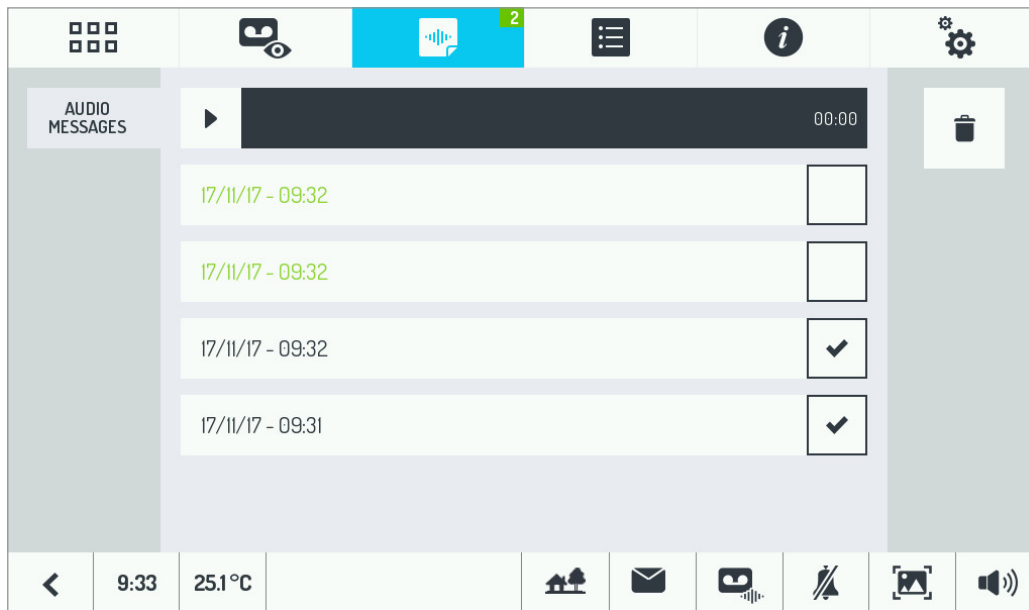

For each message to be deleted, touch the relative square; this will make a check mark appear, indicating that the message has been selected.



Select the  button to eliminate all the messages marked with a check mark.

## AUTOMATIC DOOR OPENER

The function of the automatic door opener makes it possible automatically open the door when a call is forwarded from outside to the apartment.

To enable the automatic door opener, turn on the video door phone and touch the  icon, then

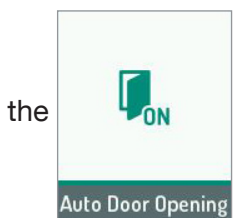

Once enabled, a check mark will appear next to the button

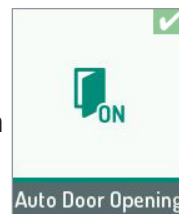

and the LED to the bottom right .

 To disable the automatic door opener, proceed in the same way as for the activation.

## ALARMS

### ARMING

It is possible to arm the alarm function if at least one sensor is connected.

Turn on the video door phone and arm the alarm by touching first the  icon and then the relative button.

A check symbol will appear next to the button:

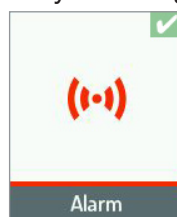

The alarm LED at the top right  flashes green during the potential exit time (any potential alarms during the exit time have no effect) and become a green steady light when ended, so signal that is has been armed.

The video door phone will turn off automatically after 60 seconds from the last button pushed.

## ALARM

When a sensor that is normally closed changes status, the master video door phone indicates the following:

- If an entrance time was set, for all this time the alarm LED ((Ⓢ)) to the top right flashes green.
- Once the entrance time has expired, the alarm LED ((Ⓢ)) to the top right becomes a steady red.
- If armed, the acoustic signal is emitted for 60 seconds.
- If armed, a video recording for a set duration (max. 30 seconds) is started following a set delay (maxi. 50 seconds),
- A fixed image will appear, with the option of turning off the acoustic signal (during the video recording, the camera that is recording the videoclip is instead visualised):

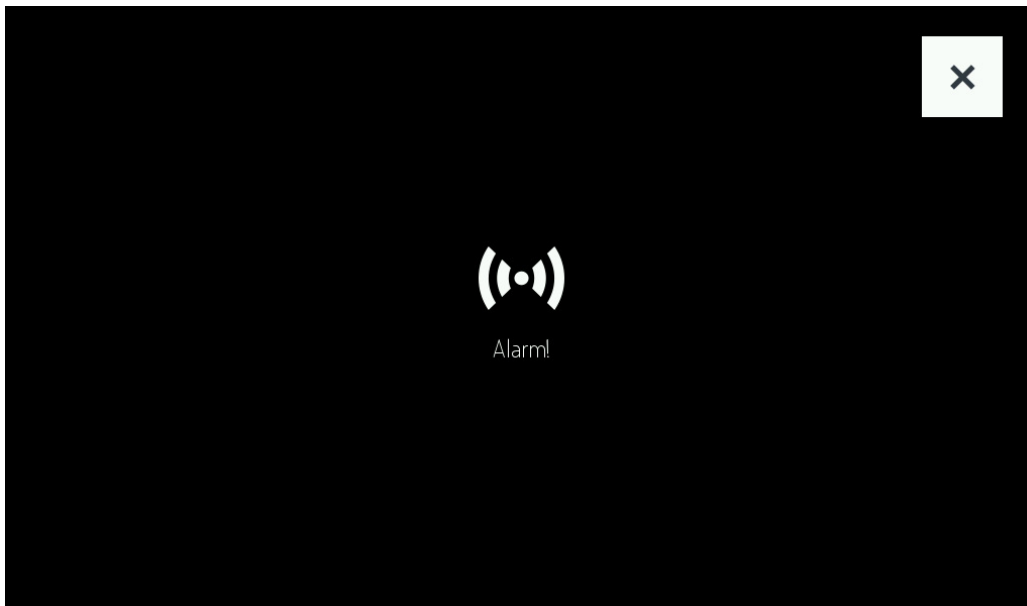

In correspondence to the alarm, other signals may be sent according to the settings made. For example, it will then be possible:



- To send signals to an external siren.
- To activate a specific home automation scenario (for ex: turning on the lights in the garden).
- Send the alarm message to your smartphone (the CallMe call forwarding function must be configured on the Ref. 1723/98 must be configured with the CallMe call forwarding function and the CallMe App must be installed and appropriately configured on the mobile device)

This indication will generate a Push Notification on the smartphone, like:



**IMPORTANT NOTE:** It is possible to reclose and reopen the alarm sensor, thereby simulating a second alarm. However, it is necessary to carry out this second simulation **AT LEAST 90 SECONDS** following the first alarm simulation. Indeed, every time an alarm sensor is triggered, the video door phone ignores successive alarms for about 90 seconds.

## SIGNALLING THE ALARM HAVING BEEN ACTIVATED (ALARM MEMORY)

The memory of the alarm having been activated (one or more) is indicated to the user (upon his return home) by the flashing red alarm LED  (and also by the video memory LED  flashing green, if a videoclip was recorded).

## DEACTIVATION

The deactivation of the alarm usually takes place during the entrance time<sup>(4)</sup>, by touching the  icon again so that the check mark disappears.

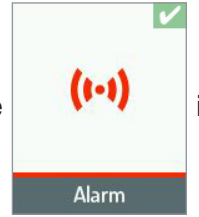

## CONSULTING THE ALARM LOG MENU

All the alarms are memorised on the master video door phone and can be consulted by touching first the  icon and then the 'Alarms' tab.

A list of the last alarms detected will appear, indicating the date and time:

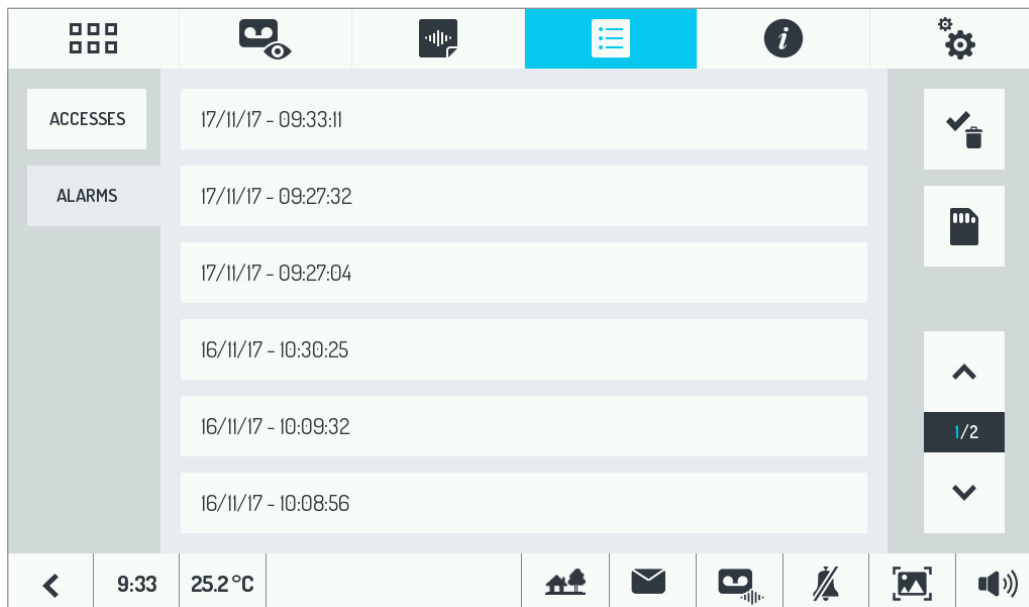

The CallMe App can also be used to consult the alarm log menu. It will be analogous<sup>(5)</sup> :

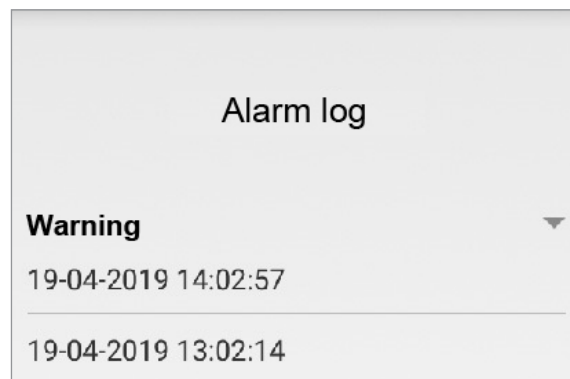

For information on how to consult the log, saving it on a microSD card and the deletion of the videoclips recorded automatically following an alarm, see the instructions on *VIDEOCLIP CONSULTATION*, *SAVING VIDEOCLIPS*, *DELETING VIDEOCLIPS* in the 'Video door phone answering service' section.

(4) During the entrance time it can be noted that:

- If there was no previous alarm, the LED  flashes green.

- If there was a previous alarm, the LED  flashes green and red alternatively (alarm memory).

(5) The title of this page can be personalised on the Call Forwarding device using the CallMe App.

## SAVING THE ALARM LOG MENU

It is possible to save the log of all the alarms on a microSD card.

Turn off the master video door phone display using the central button and insert a microSD card<sup>(6)</sup> :

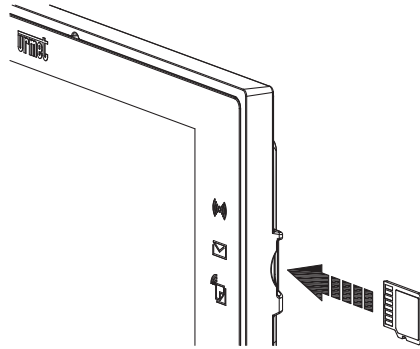

Turn on the video door phone again and touch the  icon first and then the 'Alarms' tab.

A list of the last alarms detected will appear, while to the right an icon with the symbol to save on the microSD card appears  :

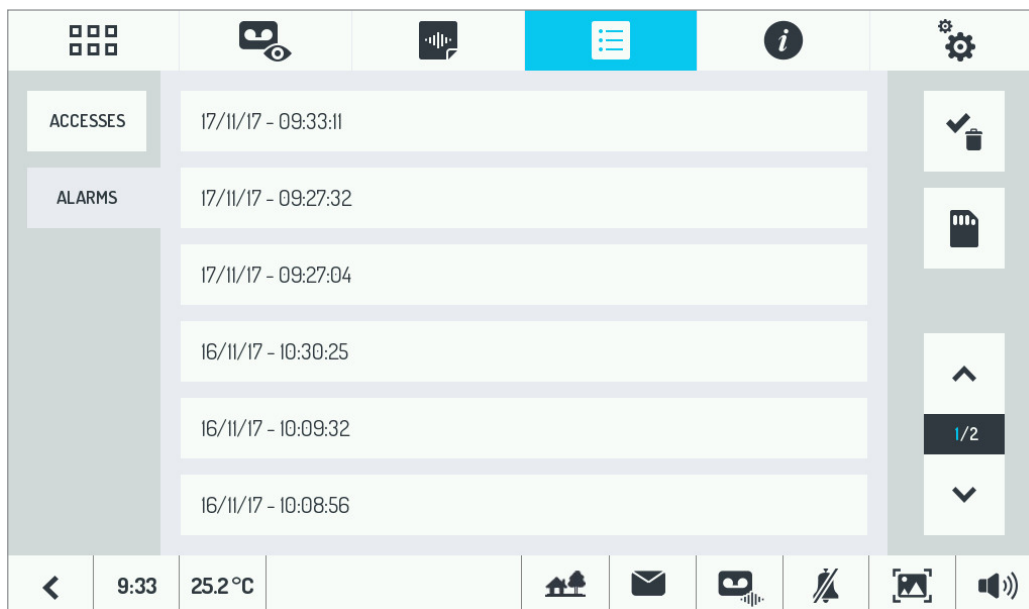

Touch the icon with the symbol of the microSD card to the top right: saving will be started. During saving, the icon will turn blue, usually for a very short time.

**IMPORTANT: DO NOT EXPEL THE microSD CARD WHILE THE ICON IS BLUE.**

When saving is complete, the icon will turn black on a white background: it is then possible to expel the microSD card.

The alarm log will be stored in a Folder of the microSD card named 'LOGS'.

If this folder does not exist, it will be automatically created before saving the file.

This is a text file that can be visualised on a PC with any text editor.

(6) Use a standard microSD card and not a microSDHC.

## DELETING THE ALARM LOG

Turn on the video door phone and touch the  icon, then select 'Alarms' to access the alarm log.

When the  icon next to each alarm is touched, a square will appear.

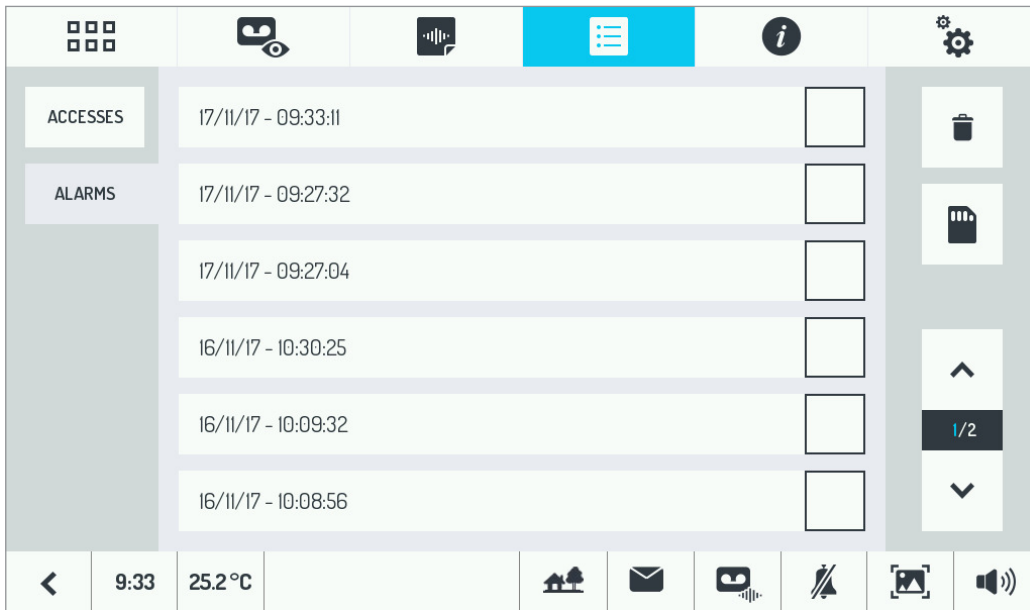

For each item to be deleted, touch the relative square and a check mark will appear.

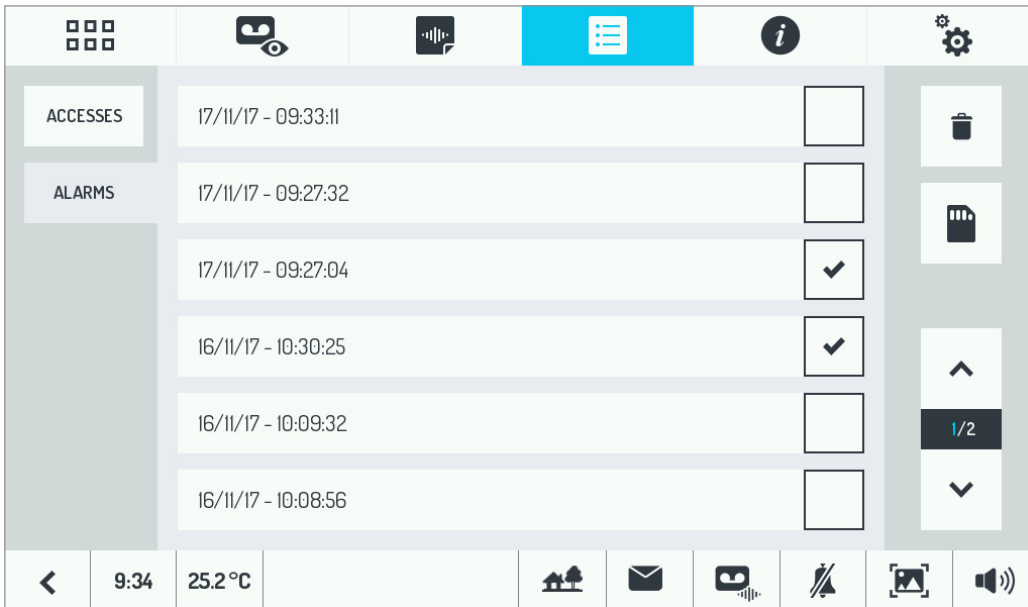

Select the  button to eliminate all the alarms marked with a check mark.

## DOOR OPENING LOG

All the door and gate openings, whether they are triggered by the video door phones, by the door units via the passage of proximity keys, or by hall buttons, are saved in the system. To consult the door opening log, turn on the video door phone and touch the  icon. The following page will appear:

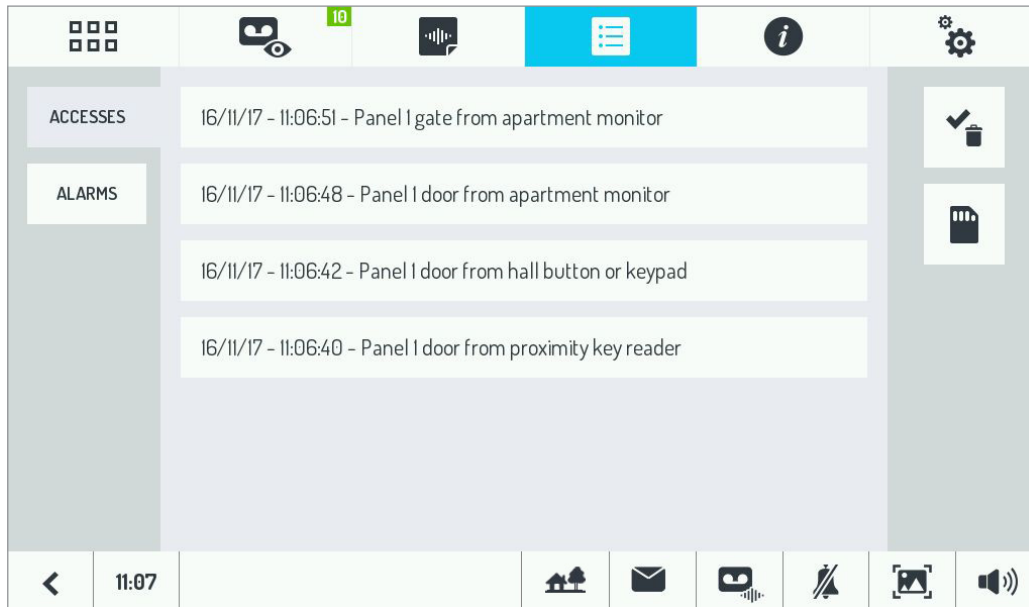

For further information on saving files to the microSD card and deleting them, see the sections *SAVING THE ALARM LOG MENU* and *DELETING THE ALARM LOG*.

## CALL FORWARDING TO SMARTPHONES AND TABLETS

The call forwarding function can be used to send an audio-video or an audio-only call to Android or iOS smartphone. Up to 4 smartphones can be managed. An Internet connection is used through an ADSL or 3G/4G router/modem or WiFi.

**IMPORTANT: The call forwarding function can only be enabled on master video door phone Ref. 1723/98.**

The **Urmet CallMe App** must be installed on a smartphone, connected to the Internet via its own mobile data connection or Wi-Fi, to receive calls.

Functions of the Urmet CallMe App include:

1. Intercom calls to other smartphones connected to the same account.
2. Auto-on function (“Camera” function on the CallMe app) to see the image taken from the door unit, from any CCTV surveillance cameras connected to the door unit or a local camera connected directly to the master video door phone on your smartphone.
3. Missed call and alarm list function.

The Urmet CallMe App is also indispensable for configuring the call forwarding function.

## ACTIVATION

Switch on the video door phone and press the  button to access the “Configuration” menu.

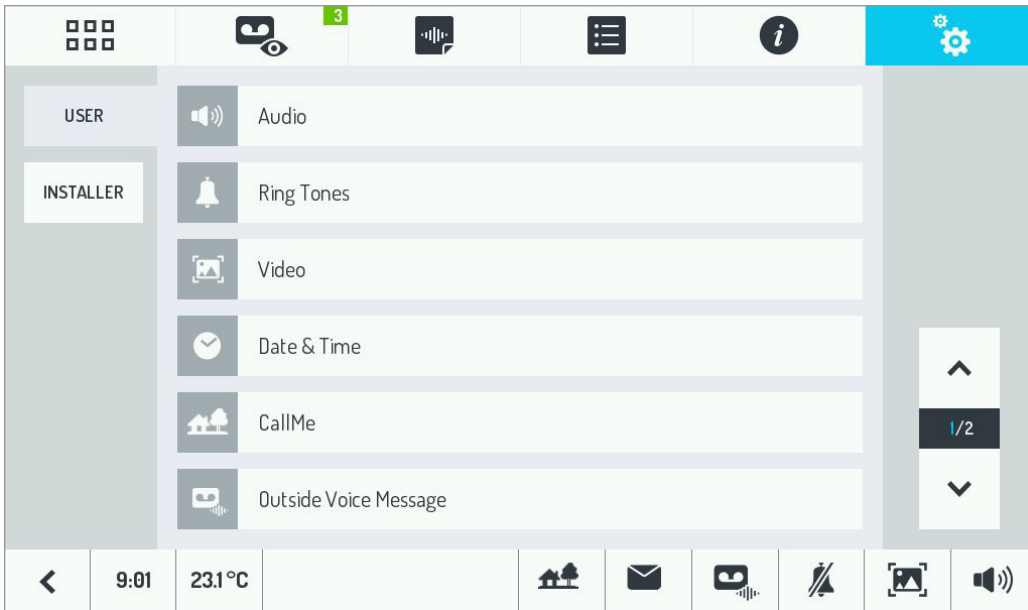

Press “CallMe” to enter the configuration menu.

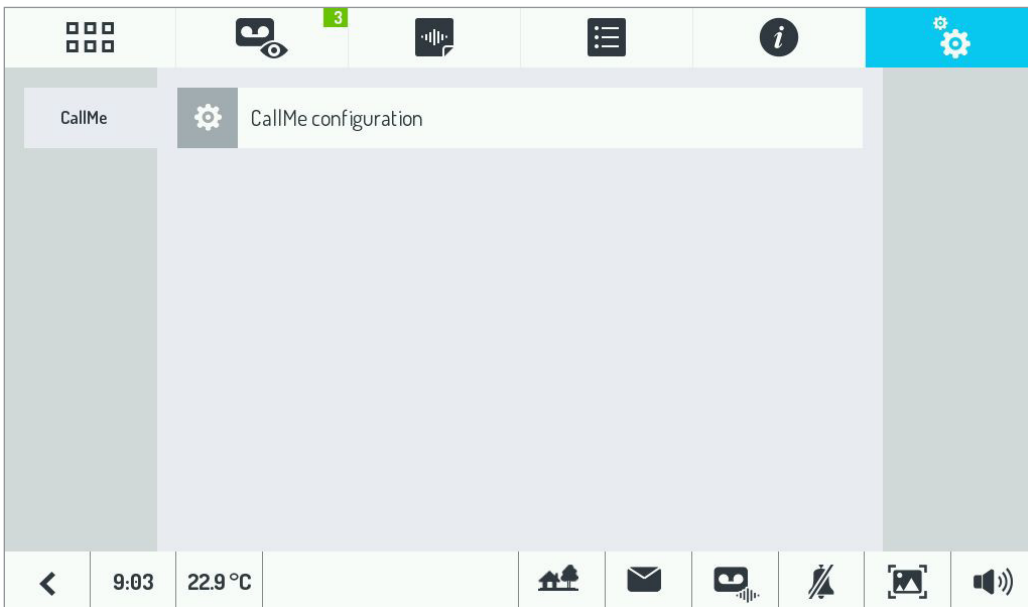

Press “CallMe configuration” to turn on the WiFi of the video door phone.

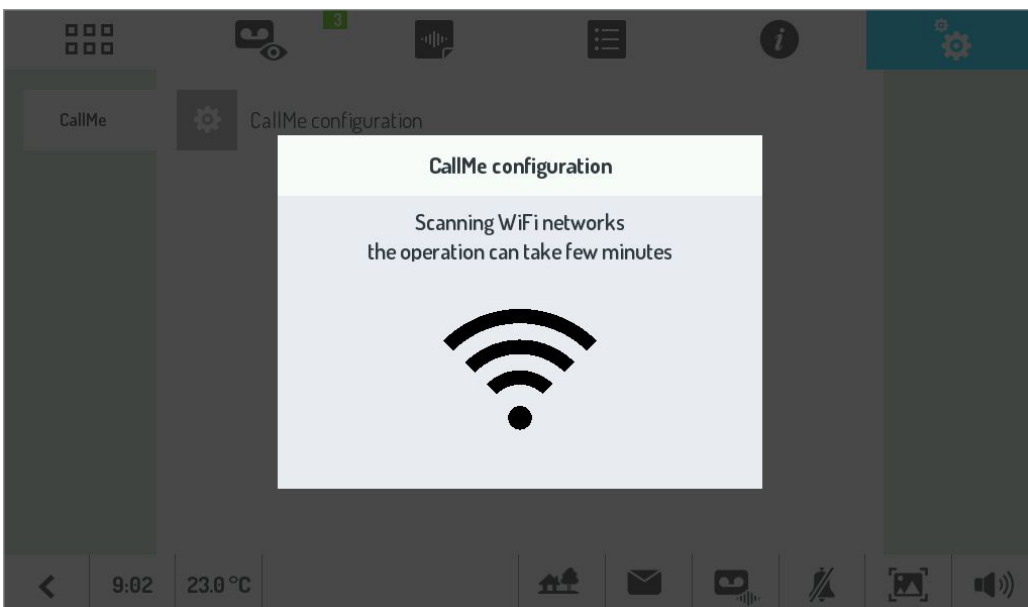

The video door phone will switch to configuration mode and the following screen will be displayed after a few seconds:

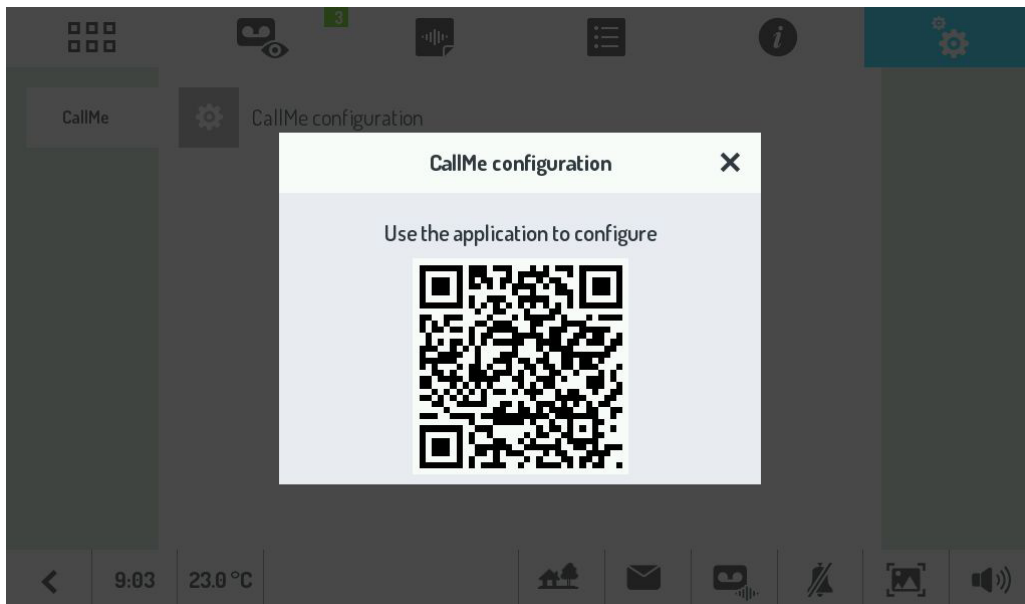

To configure the call transfer function on the master video door phone Ref. 1723/98, scan the QR-Code with the camera of your smartphone or tablet to download the **Configuration manual of the CallMe app**:



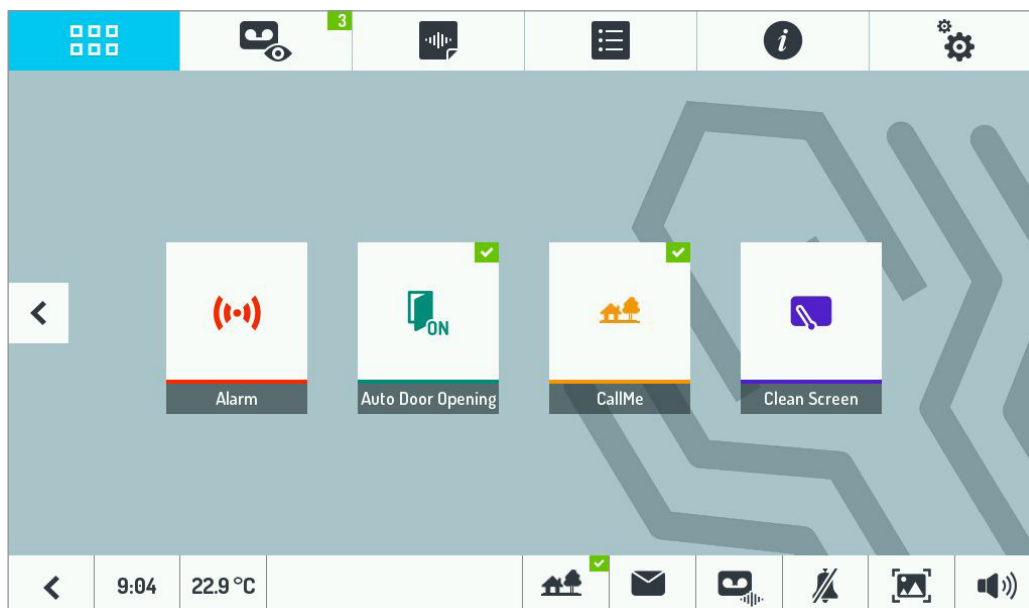

<http://qrcode.urmet.com/default.aspx?prodUrmet=156803&lingua=en>

After configuration, go back to the homepage and press the  button. The following page will appear:



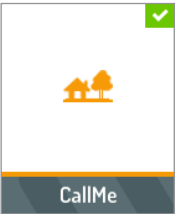

When the  yellow LED on the video door phone lights up and the green tick on the status icon  and

the button  is displayed, it means that the call forwarding function is active.

**IMPORTANT** The following actions are not possible when the call forwarding function is enabled:



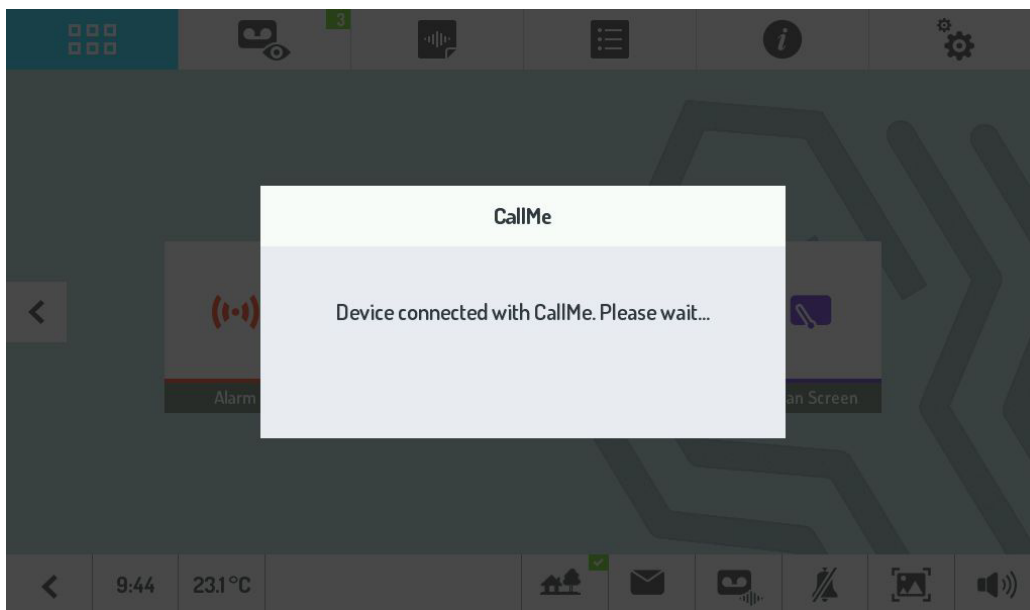

- activating the automatic recording function;
- changing the image format from 4:3 to 16:9 during a conversation;
- change the date and time of the video door phone, which is detected directly from the network via the CallMe App.

When a smartphone conversation is in progress with a calling station or an intercom call is in progress with a secondary video door phone (slave) or the auto-on function is selected, the master video door phone Ref. 1723/98 will not perform any function and the following screen will appear:



## CALL FORWARDING FUNCTION STATUS ICON

The  icon indicates the status of the call forwarding function on the video door phone.

-  Function not enabled.
-  Recording in progress on Urmet Cloud.
-  Function enabled.
-  Recording error on Urmet Cloud.
-  WiFi-OFF interval active (optional status configurable using the CallMe App).

When the call forwarding function is active, press the status icon to test the connection (testing is not possible when the device is in WiFi-OFF active  interval state).

A screen showing the test result is displayed after a couple of seconds.

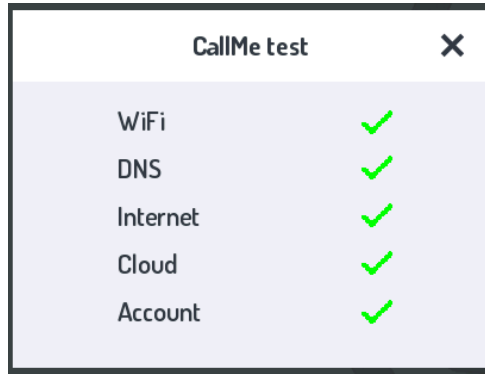



The test checks the following parameters:

- WiFi runs a diagnostic test on the default gateway
- DNS runs a diagnostic test on the DNS
- Internet runs a diagnostic test to the site *www.google.com*
- Cloud runs a diagnostic test on Urmet Cloud
- Account checks that the account used on the CallMe App is properly registered.

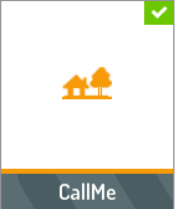
## DEACTIVATION

Press the  button on the Homepage to deactivate the call forward function.

When the function is deactivated, the  LED on the video door phone will switch off, the tick symbol on the

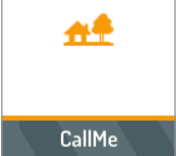
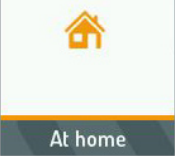
 status icon will no longer be visible and the  button will be replaced by the  button.

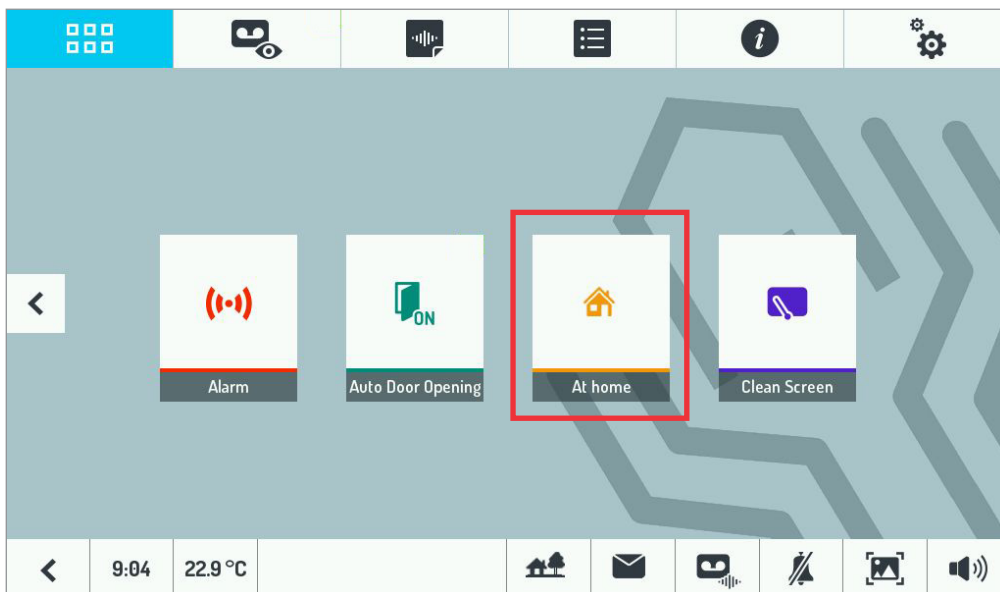

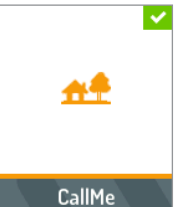
The  button is multifunctional and it can be used to activate and deactivate the call forwarding

function and to activate/deactivate the automatic recording function (see the VIDEO DOOR PHONE ANSWERING SERVICE paragraph).

## CALLME APP USER MANUAL

Refer to the “User Manual” link on the “info” screen of the app for the CallMe App user manual.

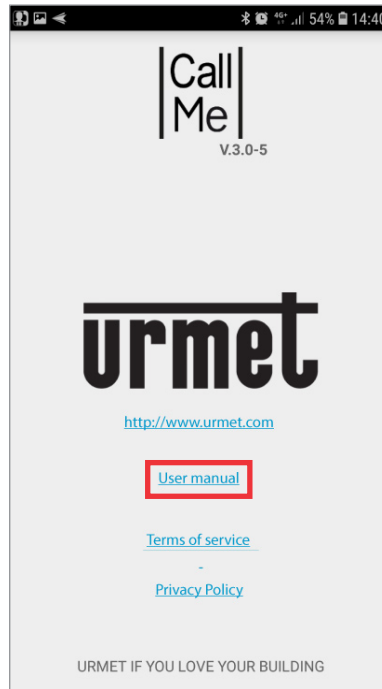

## CLEANING THE SCREEN

The ‘Clean Screen’ function makes the video door phone insensitive to any pressure. This function is useful for avoiding the involuntary activation of video door phone functions when the user wishes to clean the screen.

Turn on the video door phone and activate the function by touching first the  icon and then the relative

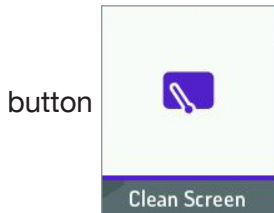

The touchscreen and the  button are inhibited for 30 seconds, after which the video door phone resumes normal functioning.

Once the clean screen function has been activated, it is not possible to anticipate its deactivation.

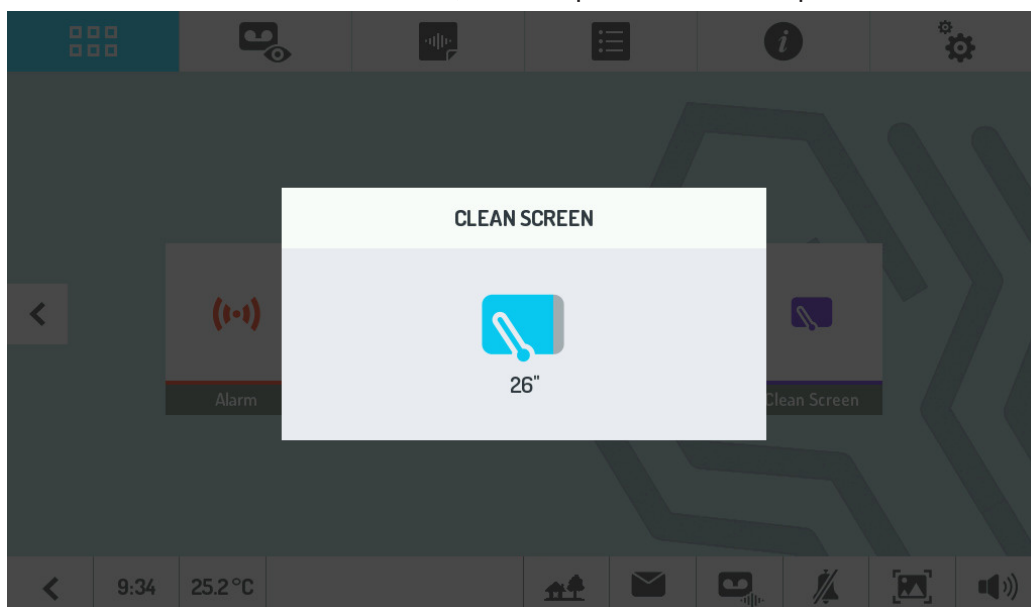

## USING THE THERMOSTAT

Only if the Thermostat function was enabled the temperature detected by the probe will appear on the bottom left of the Home Page, next to the time:

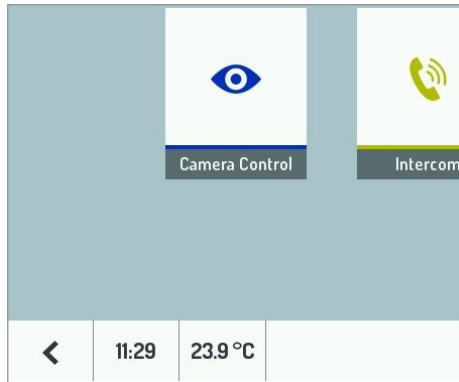

Touch the temperature and a pop-up menu will appear that makes it possible to set the desired temperature:

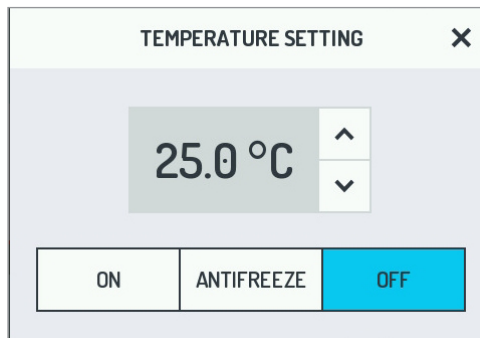

Use the arrows to change the value of the temperature set.

It is also possible to set the thermostat to maintain the default anti-freeze temperature (a value which can be modified only in the 'Configuration' menu) or turn off the thermostat (for ex. during the summer months).

Some further thermostat regulations are included in the 'Configuration' menu because they are rarely used.

From the 'Configuration' menu, accessible from the  icon to the top right, select, in the 'User' menu, the item 'Temperature Control':

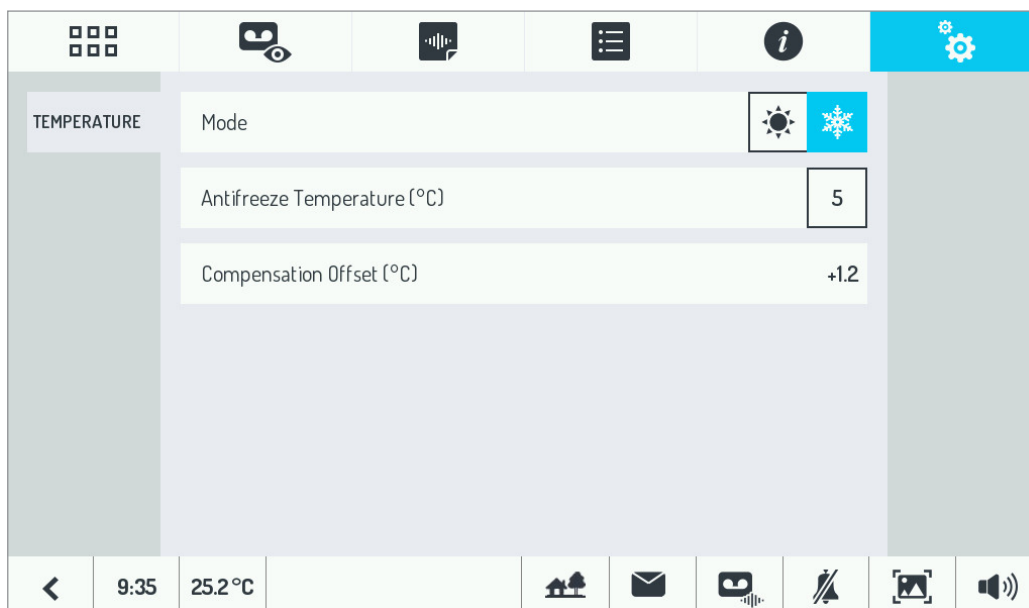

Possible settings:



- The basic thermostat functions: summer or winter (DEFAULT).
- The anti-freeze temperature (which becomes the protection temperature if the thermostat is configured in summer mode).

- The offset to be applied to the temperature detected by the probe (useful for example when the probe was positioned in a point in the room that was too hot or too cold). By selecting this line, a pop-up will appear, making it possible to define the offset.

## PUSH TO TALK (PTT) MODE

In some situations, for example in particularly noisy environments, it may be useful to use the ‘Push to talk’ mode. This function makes it possible to activate a one-way audio, so that the parties may speak one at a time while avoiding the overlapping of environmental noises.

 **To activate the ‘Push to talk’ mode mode it is necessary to act on the configuration of the dip-switch on each video door phone. See the installation manual for more details.**

When in this mode, pressing the soft touch  key activates the audio from the inside to the outside, and when it is released the audio is activated from the outside to the inside. When a call is received, answer normally by pressing the soft touch  button and releasing it.

## LETTERBOX FUNCTION

 **For the ‘LETTERBOX’ to be activated, the system must be suitable configured. See the installation manual for more details.**

The ‘LETTERBOX’ function makes it possible to visualise a new mail notification on the video door phone. When mail is inserted into the front cover, the LED  on the master video door phone begins to flash green. To stop this signal:

- Touch the mail icon  on the master video door phone.
- Open the cover to the letterbox and remove the mail.

 **After transmitting the arrival of new mail from the letterbox, it is necessary to wait at least 10 seconds before being able to generate a new signal.**

## CHANGING THE VIDEO DOOR PHONE SETTINGS

To access the ‘Configuration’ menu, turn on the video door phone and touch the  icon.

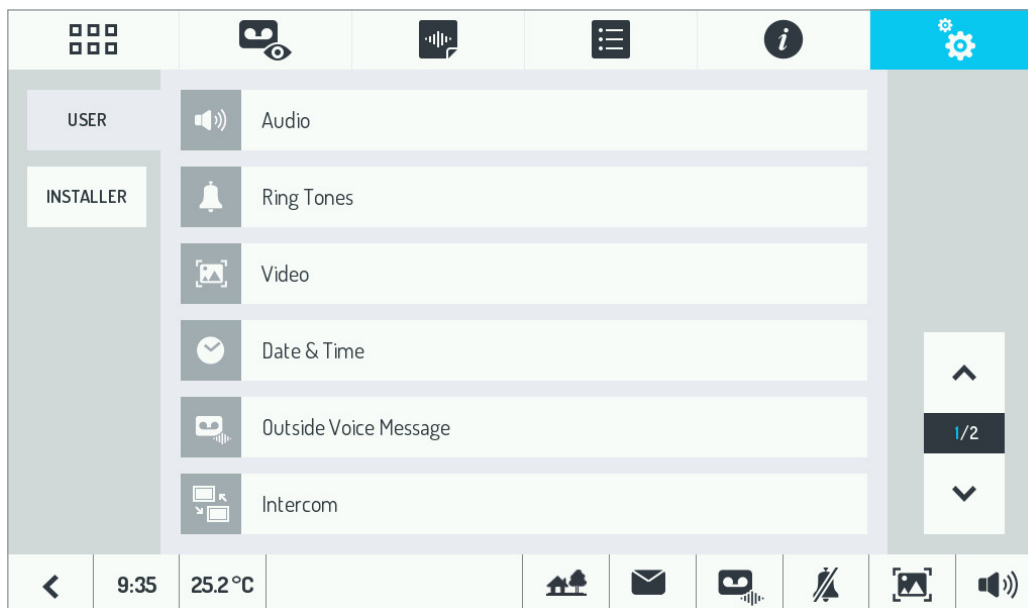

The menu is divided into two pages; shift from one page to the other using the up and down arrows at the bottom right.



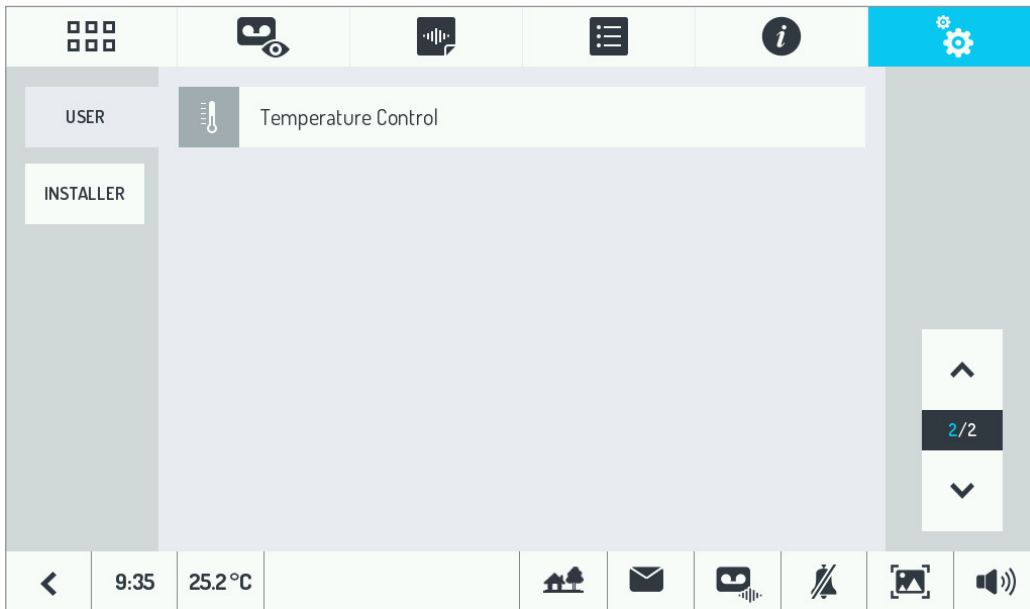

**IMPORTANT** It will not be possible to display the “Date and Time” entry if the call forwarding function is active.





## AUDIO SETTINGS

In this page it is possible to vary the audio level of the ring tone (  ), of the speaker (  ), and enable or disable the sound of pressing of the keys on the display (  ).

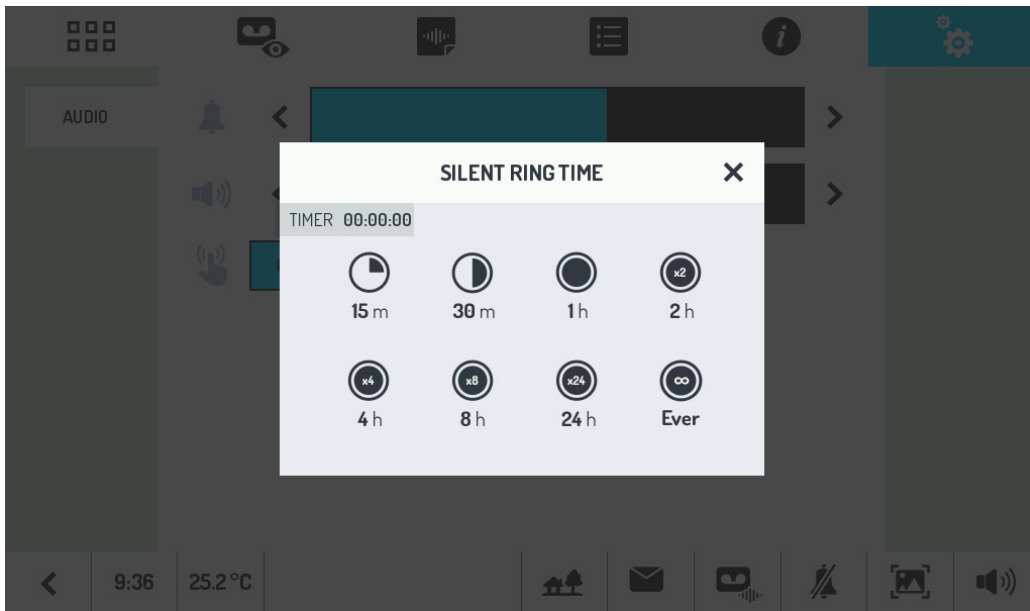

If the user should decide to silence the ring tone of the video door phone, for example while sleeping, it is sufficient to touch the soft touch  button below. To reactivate the ring tone, touch the  button again. Otherwise, it is possible to silence the ring tone only for a set period of time. Once the time has expired, the ring tone will reactivate automatically. To use this mode, touch the  icon on any page. The following page will appear:



Touch one of the values proposed, then close the window using the  button.

Regardless of the mode selected, the  LED will light up red to indicate that the audio of the ring tone was silenced and will turn off when the audio is enabled again.

## SELECTING THE MELODIES

To select the melodies for each type of call and the alarm notification, select the 'Ring Tones' item in the 'Configuration' menu.

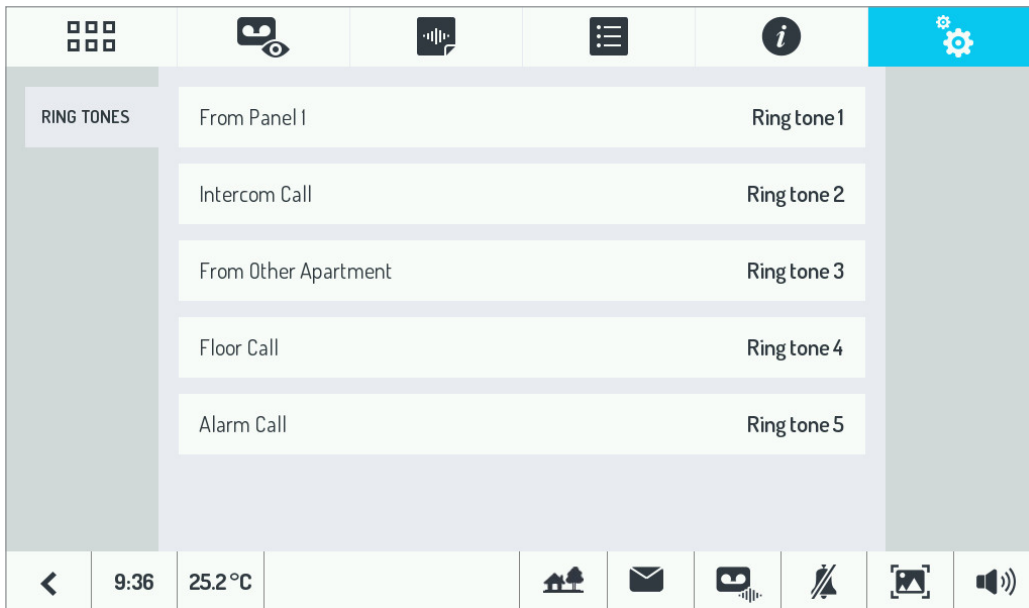

From this page it is possible to select a melody (from among the 5 proposed) for the calls from an external door unit, intercom calls from other video door phones installed in the same apartment, intercom calls from video door phones in the adjacent apartment, floor call, and the alarm signal.

When the signal to be personalised is selected, the following page will be visualised:

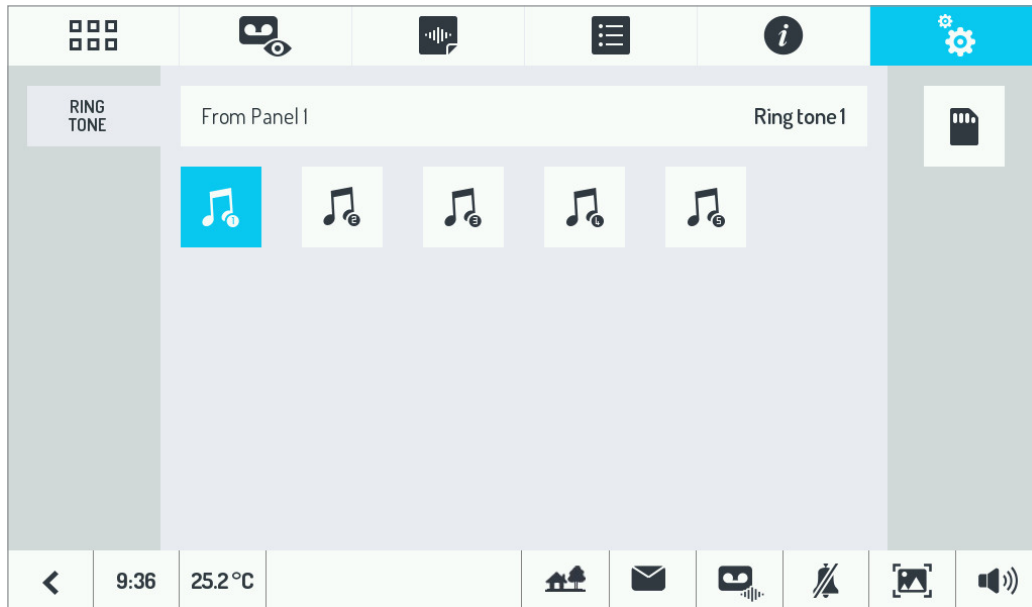

Then touch the  icons of the individual melodies to listen to them.

It is possible to use personal ring tones. Just create a 'SOUNDS' folder in the in the microSD card where the desired melody can be copied.

-  To be able to be uses as a ring tone, the audio file must have the following characteristics:
- Maximum length of 20 seconds
  - 128kbps MONO in WAVE format (16 bit @ 8kHz).
  - The maximum length of the name of the file is 32 characters.

All the files that do not conform to the criteria listed above will not be visualised. Touch the icon of the microSD card to see the list of the audio files available.

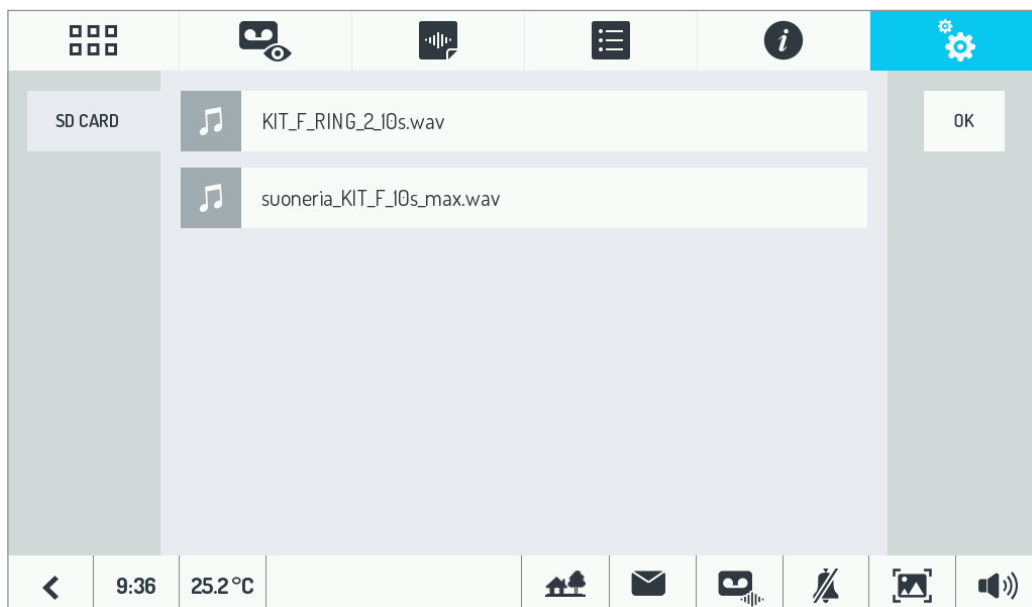



## BACK-LIGHTING

To set the level of luminosity of the video door phone display, select the item 'Video' in the 'Configuration' menu.

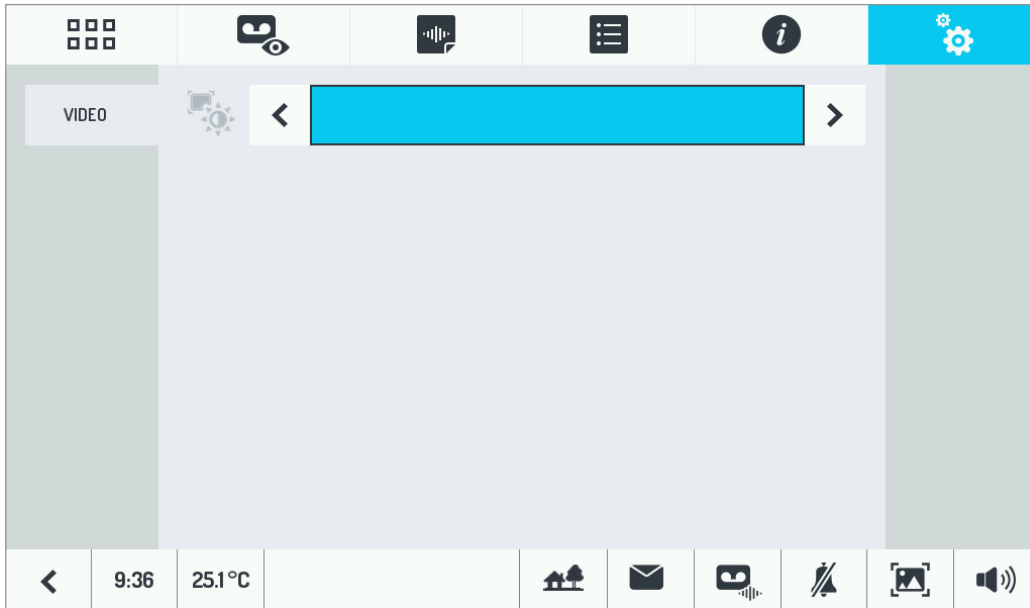

## DATE AND TIME

To set the date and time, select the item 'Date & Time' in the 'Configuration' Menu.

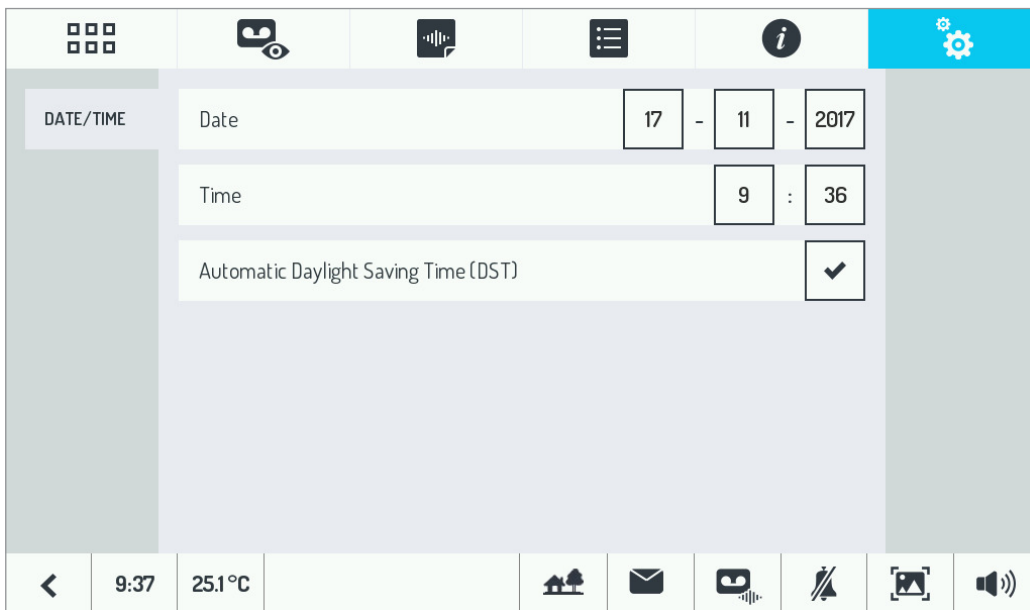

When entering the date and time, it is necessary to FIRST cancel the contents of the field and THEN insert the new value desired. To move from one field to another, touch the desired field.

 *The change from solar to daylight savings time (and vice-versa) occurs according to the time difference of Greenwich (GMT). Therefore, the time difference in Central Europe (France, Italy, Germany, etc.), when changing from solar to daylight savings time, the time is moved ahead one hour at 1 o'clock in the morning (and not at 2 o'clock). Likewise, in the case of the passage from daylight savings time to solar time, the time is put back one hour at 2 o'clock in the morning.*

## INTERCOM: SETTING THE VIDEO DOOR PHONE NAMES

In the 'Configuration' menu, select the item 'Intercom'. The following will appear:

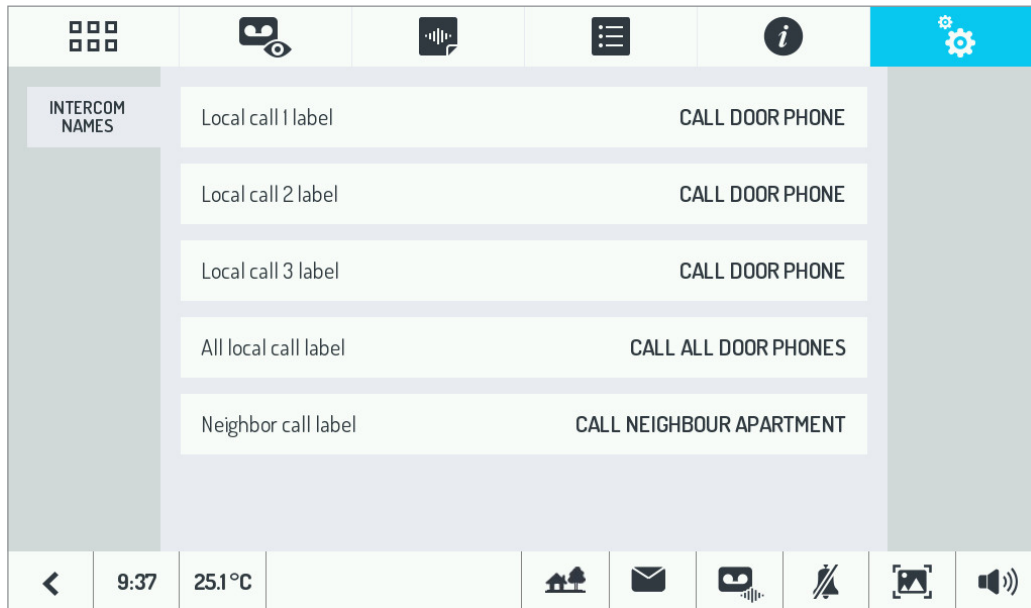

In this page there is a list of the other 3 video door phones (other than the one being used) and a fourth item for the general call.

Attribute the correct name to the video door phones present (for ex. 'First Floor' and 'Loft') and the name '-' to those not present.

If the call sending device is installed, it always substitutes only the video door phone 3.

Then attribute video door phone 3 a meaningful name, like 'Cellular/s'.

Finally, assign a meaningful name to the general call as well, for ex. 'General Call'.

## ACCESS CONTROL

The kit comprises 5 transponder keys and 2 chip tags for electric lock activation.

The chip tag is the sensor contained inside the keys and can be attached to various objects of daily use (keyholder, cell phone, watch. etc.).

To open the door, move a key or the object to which the chip tag has been attached close to the name tags area of the call station (the correct point is indicated with (( )) as shown to the side.

 *The keys and the chip tag must be associated to the call station as indicated in paragraph "Key memorisation procedure".*

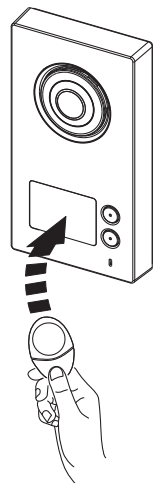

If a valid key is presented, the call station emits a confirmation beep and activates the electric lock. If an invalid key is presented, the call station emits a long beep and the electric lock is not activated.

## KEY MEMORISATION PROCEDURE

Only keys memorised can activate the electric lock connected to the call station. To memorise the keys:

1. Move the master key close to the call station;
2. The call station emits a confirmation beep;
3. Move the key or chip tag to be programmed close to the call station;
4. The call station emits two beeps to indicate that programming has been completed;
5. Repeat operations 3 and 4 for all the keys to be programmed;

 *Up to 21 keys can be programmed. If an attempt is made to program a twenty-second key, the call station emits only one beep (instead of 2) to indicate that programming has not been performed.*

6. Move the Master key close to the call station;

- The call station emits three beeps to indicate exit from programming. In case of forgetfulness, the exit programming mode will be done automatically after 30 seconds.

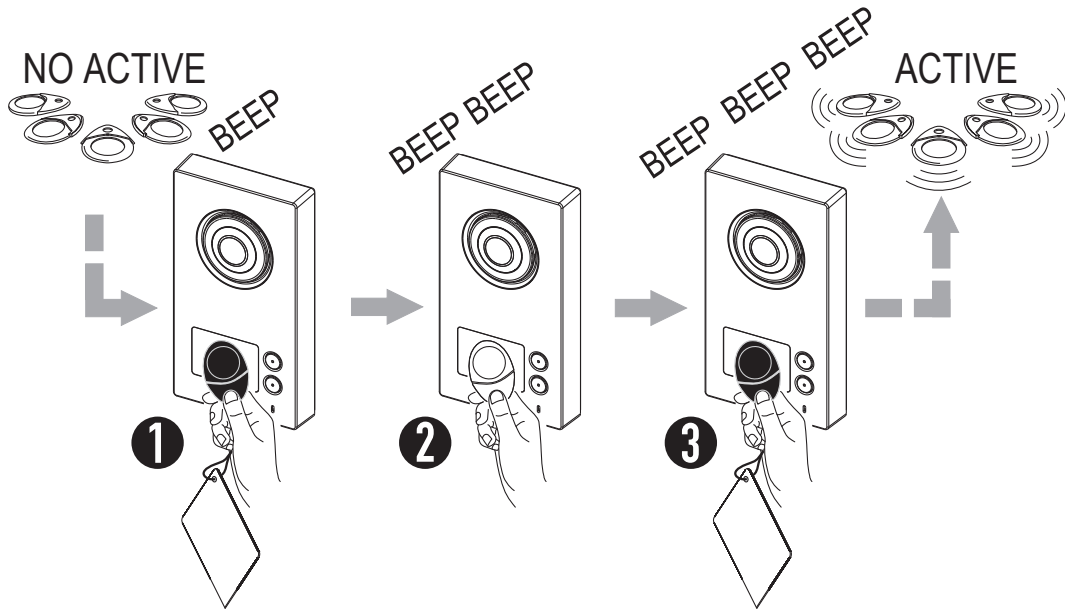

### KEY CANCELLATION PROCEDURE

To cancel the keys programmed:

- Move the Master key close to the call station.
- The call station emits a confirmation beep.
- Hold the Master key in front of icon ( ))) for at least 5 seconds.
- The call station emits a long confirmation beep. Remove the key immediately.

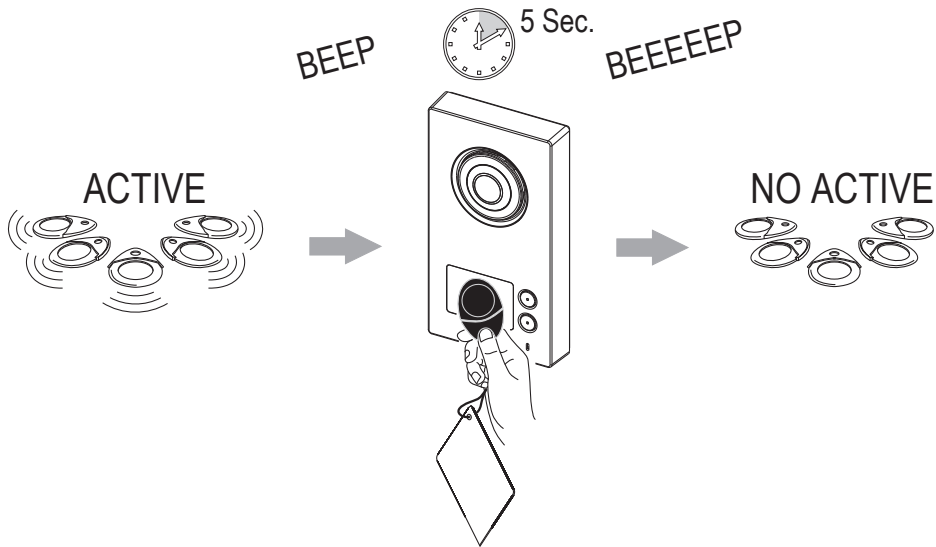

***In this way, all the keys saved up to this moment will be cancelled.***

**DS 1723-057**

URMET S.p.A.  
10154 TORINO (ITALY)  
VIA BOLOGNA 188/C  
Telef. +39 011.24.00.000 (RIC. AUT.)  
Fax +39 011.24.00.300 - 323

**urmet**

**LBT 20878**

Area tecnica  
servizio clienti +39 011.23.39.810  
<http://www.urmet.com>  
e-mail: [info@urmet.com](mailto:info@urmet.com)